



LPG/CNG

PRZEWODY I CEWKI ZAPŁONOWE



**JANMOR**

SYSTEMY ZAPŁONOWE

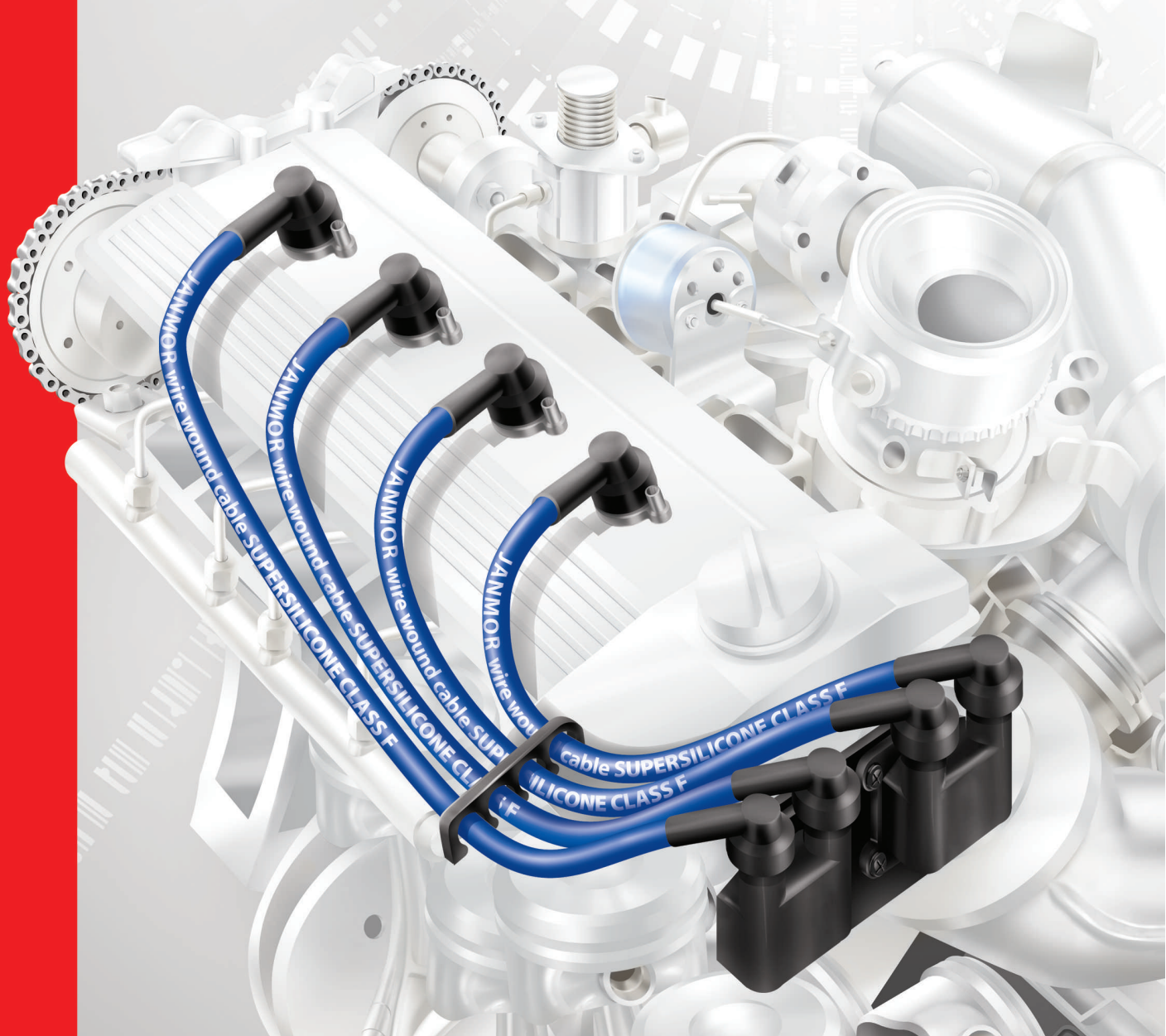

**SAMOCZODY AMERYKAŃSKIE 2015**



➤ **PROLINE** to marka najwyższej klasy przewodów zapłonowych w izolacjach i osłonach silikonowych. W ofercie posiadamy wersję z rdzeniem wire wound oraz miedzianym.

➤ **ECOLINE** to marka przewodów zapłonowych, charakteryzujących się najlepszym stosunkiem jakości do ceny. W ofercie posiadamy wersję z rdzeniem kevlarowym oraz miedzianym.







## ➤ SPECYFIKACJA TECHNICZNA I CECHY PRZEWODÓW

### PROLINE

S E R I E S

### ECOLINE

S E R I E S

	WIRE WOUND	MIEDZIANY	KEVLAR	MIEDZIANY
Przewodnik prądu	mieszanka ferromagnetyczna + zwoje drutu 50 /cm	miedź 1 mm <sup>2</sup>	kevlar	miedź 1 mm <sup>2</sup>
Rodzaj izolacji	silikon/EPDM + opłot z włókna szklanego	silikon/EPDM + opłot z taśmy nylonowej	EPDM	EPDM
Średnica	7 mm 8 mm	7 mm	7 mm 8 mm	7 mm
Dostępne kolory	niebieski, czarny, czerwony	czarny	żółty, czarny, czerwony	czarny
Oznaczenia przewodów	ABS, AFS, AM, CPS, D...S, FAS, FS, JP, ODS, RB, RVS, S, SBS, VL, W	AFM, ABM, HR, FAM, M, ODM	ABU, AFU, AMU, CPU, D...E, E, FAU, FU, JPE, ODU, RBU, RVU, SBU, VLU	ABM...P, HR...P
Gwarancja	 3 YEARS WARRANTY  RECOMMENDED FOR LPG/CNG	 3 YEARS WARRANTY  RECOMMENDED FOR LPG/CNG	 2 YEARS WARRANTY	 2 YEARS WARRANTY

## > OSŁONY

Stosowane przez nas osłony spełniają wymagania dotyczące:

- **szczelności połączenia**, które uzyskujemy przez wykorzystanie osłon o kształcie identycznym jak w wiązkach oryginalnych oraz stosowanie specjalnych klejów przy łączeniu kilku elementów.

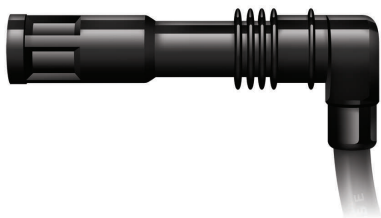

- **zapewnienia wysokiej jakości izolacji**, co otrzymujemy stosując jako surowiec silikon,
- **odporności na znaczne wahania temperatur oraz czynniki chemiczne i atmosferyczne**, co uzyskujemy przez stosowanie surowców wykonanych z silikonu, ze względu na jego właściwości.

## > TERMINALE

Stosowane przez nas terminale zapewniają **możliwie najlepsze połączenie pomiędzy żyłą prądową a kopułką lub świecą**. Pewność połączenia uzyskujemy poprzez dopracowaną przez nas technologię odizolowania

rdzenia przewodów oraz jego odpowiednie ułożenie i zaciśnięcie na terminalu. Stosujemy terminale o szczególnie dobranym kształcie i budowie tak, żeby zapewniły zawsze sprężyste połączenie między przewodem zapłonowym a kopułką lub świecą.

- > ząbkowanie zacisków zapewnia wytrzymałość połączenia

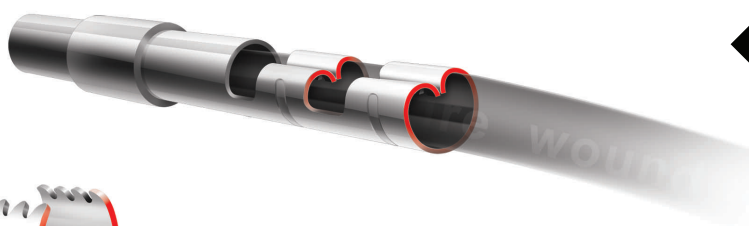
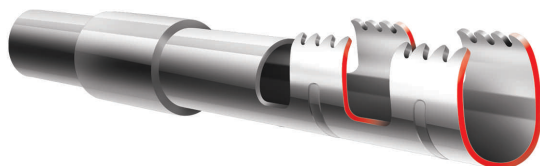

- > terminal zaciśnięty na przewodzie - ząbki mocno osadzone na kablu

## > IZOLACJA PRZEWODÓW

**Zewnętrzna izolacja silikonowa** zapewnia największy stopień ochrony przed czynnikami zewnętrznymi

tj. odporność na działanie kwasów, olejów i smarów, wysoką odporność termiczną oraz odporność na przebicie do 70.000 V.

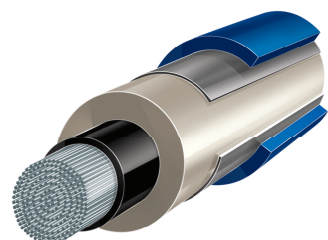

- > przewód z rdzeniem węglowym

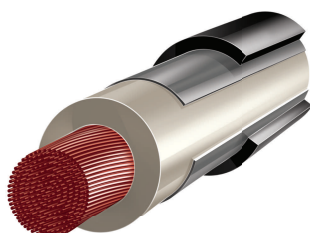

- > przewód z rdzeniem miedzianym



- > przewód z rdzeniem wire wound

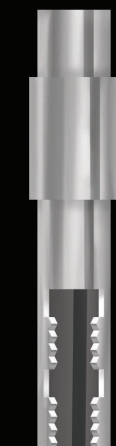

## ➤ CEWKI ZAPŁONOWE

Naszą ofertę cewek zapłonowych stanowi już prawie 600 szczegółowo dobranych pod względem jakościowym referencji. Tak duża liczba cewek umożliwia prawie 100 – procentową skuteczność ich właściwego doboru zarówno do aut produkowanych współcześnie jak i pojazdów zabytkowych. Sporą część oferty oznaczamy mianem wysokiej jakości HQ, co oznacza, że są to cewki największych światowych producentów OEM, dostarczających swoje wyroby na pierwszy, fabryczny montaż.



## ➤ PRZEWODY DO POJAZDÓW ZABYTKOWYCH

Przewody zapłonowe JANMOR RetroLine to propozycja dla właścicieli pojazdów zabytkowych, w przypadku których zakup części zamiennych jest mocno utrudniony.

Założeniem linii Retro jest możliwość dorobienia indywidualnego kompletu przewodów w oparciu o stare oryginalne kable, ewentualnie ich fotografię lub rysunek.

Choć przewody wyglądają na stare, to wykonane są z najlepszych jakościowo materiałów dostępnych do ich budowy. Często stosuje się tu zgodne z oryginalnymi osłony ebonitowe, które nakręca się na miedziany rdzeń przewodu silikonowego. Nowością jest też możliwość zamówienia przewodów w dodatkowym oplocie bawełnianym, które wyglądem przypominają te montowane w samochodach z początku XX wieku.



# > LIST OF SYMBOLS USED

> SPIS UŻYTYCH SYMBOLI > СПИСОК ПРИМЕНЕННЫХ СИМВОЛОВ > LISTE DER VERWENDETEN SYMBOLE



## Engine capacity

Pojemność silnika  
Объем двигателя  
Rauminhalt  
Cylindrée  
Capacidad



## Number of cables coil \ cylinders

Ilość przewodów cewka \ cylindry  
Количество проводов катушка \ цилиндры  
Anzahl der Leitungen Spule \ Zylinder  
Nombre de câbles bobine \ cylindres  
Número de cables de la bobina \ cilindros



## Manufacture years

Lata produkcji  
Год выпуска  
Vaujahr  
Date de production  
Años de producción



## Symbol of ProLine ignition lead

Symbol przewody zapłonowego linii ProLine  
Символ провода зажигания линии ProLine  
Zündkabelsymbol der ProLine Linie  
Symbole du câble d'allumage ligne ProLine  
Símbolo del conductor de encendido de la línea Proline



## Engine power kW

Moc silnika w kW  
Мощность двигателя Л.С.  
Motorleistung in kW  
Puissance moteur en kW  
Potencia del motor en kilovatios



## Symbol of EcoLine ignition lead

Symbol przewodu zapłonowego linii EcoLine  
Символ провода зажигания линии EcoLine  
Zündkabelsymbol der EcoLine Linie  
Symbole du câble d'allumage ligne EcoLine  
Símbolo del conductor de encendido de la línea EcoLine



## Engine power HP

Moc silnika w KM  
Мощность двигателя Л.С.  
Motorleistung in PS  
Puissance moteur en KM  
Potencia del motor en km



## No of pieces in a vehicle

Ilość sztuk występująca w pojeździe  
Количество штук в автомобиле  
Anzahl der Stücke pro Fahrzeug  
Nombre de pièces dans un véhicule  
Cantidad de piezas del vehículo

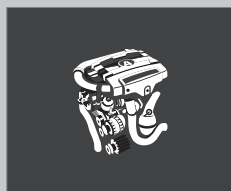

## Engine code

Код двигателя  
Kod silnika  
Motorcode  
Code du moteur  
Código del motor



## Symbol od ignition coil

Symbol cewki zapłonowej  
Символ катушки зажигания  
Symbol der Zündspule  
Symbole de la bobine d'allumage  
Símbolo del tubo de encendido

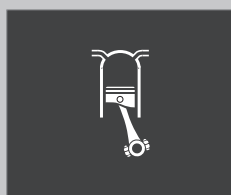

## Number of cylinders

Liczba cylindrów  
Количество цилиндров  
Zylinderanzahl  
Nombre de cylindres  
Número de cilindros

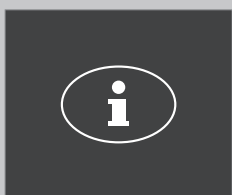

## Other info

Informacje dodatkowe  
Дополнительная информация  
Ergänzende Angaben  
Informationssupplémentaires  
Datos adicionales



## AC USA

ACE											
2.0	1955.01	1963.12	-	-	-	6		X	X	JM5210	1
2.0	1956.01	1961.12	-	-	-	6		X	X	JM5210	1
2.6	1962.01	1963.12	-	-	-	6		X	X	JM5210	1
ACECA											
2.0	1955.01	1963.12	-	-	-	6		X	X	JM5210	1
2.0	1956.01	1961.12	-	-	-	6		X	X	JM5210	1
2.6	1962.01	1963.12	-	-	-	6		X	X	JM5210	1
GREYHOUND											
2.0	1960.01	1961.12	-	-	-	6		X	X	JM5210	1
TWO-LITRE											
2.0	1955.01	1957.12	-	-	-	6		X	X	JM5210	1

## ACURA USA

CL											
2.2	1996.09	1997.12	110	150	F22B1	4		X	X	JM5174	1
EL											
1.6	1997.01	2000.12	95	129	D16Y8	4		X	X	JM5156	1
1.7	2001.01	2001.12	86	117	-	4		X	X	JM5156	1
INTEGRA											
1.7 16V	1992.01	1993.12	119	162	B17A1	4		X	X	JM5156	1
1.8 16V	1992.01	1993.12	107	146	B18A1	4		X	X	JM5156	1
1.8 16V	1994.01	1997.12	107	146	B18B1	4		X	X	JM5156	1
1.8 16V	1994.01	2001.12	129	175	B18C1	4		X	X	JM5156	1
1.8 16V	1997.01	2001.12	147	200	B18C5	4		X	X	JM5156	1
LEGEND											
2.7 24V	1987.01	1991.08	123	167	C27A1	6		X	X	JM5192	1
2.7 24V	1987.01	1991.08	130	177	C27A1	6		X	X	JM5192	1
MDX											
3.5 24V	2001.03	2002.12	179	243	J35A3	6		X	X	JM5016	6
3.5 24V	2003.04	2007.04	191	260	J35A5	6		X	X	JM5016	6
NSX											
3.0 24V	1991.01	2005.12	204	277	-	6	-	-	-	JM5187	3 right coil
3.0 24V	1991.01	2005.12	204	277	-	6	-	-	-	JM5188	3 left coil
3.0 V6 MFI DOHC	1995.01	2005.12	-	-	C30A1	6	-	-	-	JM5188	6
3.0 V6 MFI DOHC	1995.01	1998.12	-	-	C30A1	6	-	-	-	JM5187	3 right coil
3.0 V6 MFI DOHC	1995.01	1998.12	-	-	C30A1	6	-	-	-	JM5188	3 left coil
3.2 24V	1997.01	2005.12	219	298	-	6	-	-	-	JM5187	3 right coil
3.2 24V	1997.01	2005.12	219	298	-	6	-	-	-	JM5188	3 left coil
RL											
3.5 SOHC	1996.01	2004.12	-	-	C35A1	6	-	-	-	JM5187	3 right coil
3.5 SOHC	1996.01	2004.12	-	-	C35A1	6	-	-	-	JM5188	3 left coil
RSX											
2.0 Type-S	2001.09	2006.12	114	155	K20A3	4	-	-	-	JM5383	4
2.0 Type-S	2001.09	2004.12	144	200	K20A2	4	-	-	-	JM5383	4
2.0 Type-S	2004.09	2006.12	154	209	K20Z1	4	-	-	-	JM5383	4
TL											
2.5 L5 MFI SOHC	1995.01	1998.12	-	-	G25A4	5		X	X	JM5193	1
3.2 V6 MFI SOHC	1996.01	1998.12	-	-	C32A6	6	-	-	-	JM5187	3 right coil
3.2 V6 MFI SOHC	1996.01	1998.12	-	-	C32A6	6	-	-	-	JM5188	3 left coil
VIGOR											
2.5 L5 MFI SOHC	1992.01	1994.12	-	-	G25A1	5		X	X	JM5193	1

## ALFA ROMEO USA

BERLINA											
2.0	1972.01	1974.12	-	-	-	4		X	X	JM5455	1 + resistor
2.0	1972.01	1974.12	-	-	-	4		X	X	JM5455	1 + resistor
DUETTO											
1.6	1966.01	1968.12	-	-	-	4	1/4	AFS72	AFU72	JM5455	1 + resistor
SPIDER											
2.0	1974.09	1994.12	90	122	-	4		X	X	JM5455	1 -> 12.1979; + resistor
SPORT											
2.0	1977.09	1979.12	82	110	-	4		X	X	JM5455	1 + resistor

## ALVIS USA

TA21											
3.0	1950.01	1953.12	-	-	-	6		X	X	JM5210	1



### ALVIS USA

<b>TB21</b>											
3.0	1950.01	1952.12	-	-	-	6	X	X	JM5210	1	
<b>TC108/G</b>											
3.0	1956.01	1958.12	-	-	-	6	X	X	JM5210	1	
<b>TC21</b>											
3.0	1953.01	1955.12	-	-	-	6	X	X	JM5210	1	
<b>TC21/100</b>											
3.0	1954.01	1955.12	-	-	-	6	X	X	JM5210	1	

### AMERICAN MOTORS (FORD) USA

<b>CONCORD</b>											
2.5 8V	1982.01	1982.12	61	83	-	4	X	X	JM5368	1	
<b>EAGLE</b>											
2.5 8V AWD	1981.01	1984.12	61	83	-	4	X	X	JM5368	1	
<b>SPIRIT</b>											
2.5 8V	1982.01	1982.12	61	83	-	4	X	X	JM5368	1	

### AMERICAN MOTORS (GENERAL HUMMER) USA

<b>HUMMER OPEN BODY RECRUIT</b>											
5.7 V8 350cid	1994.01	1996.12	-	-	-	8	X	X	JM5369	1	VIN (D)

### AUDI USA

<b>A3</b>											
3.2 Quattro	2006.01	2007.12	184	250	BUB	6	-	-	JM5066	6	
3.2 Quattro	2008.01	-->	184	250	CBRA	6	-	-	JM5066	6	
<b>FOX</b>											
1.6	1975.09	1976.12	59	79	YK	4	X	X	JM5355	1	
<b>Q7</b>											
3.6 FSI	2007.01	2010.12	206	276	BHK	6	-	-	JM5360	6	
<b>S4</b>											
2.2 V5 Turbo DOHC	1992.01	1994.12	169	230	AAN	5	-	-	JM5269	5	JM2047 VIN (P), VIN (R)
<b>S6</b>											
2.2 V5 Turbo DOHC	1995.01	1997.12	169	230	AAN	5	-	-	JM5269	5	JM2047; VIN (A)
<b>TT</b>											
3.2 Quattro	2004.01	2006.12	184	250	BHE	6	-	-	JM5066	6	

### AUSTIN USA

<b>AMERICA</b>											
1.3	1967.09	1968.12	43	58	-	4	X	X	JM5210	1	
1.3	1969.01	1972.12	43	58	-	4	X	X	JM5355	1	+ resistor
<b>MARINA</b>											
1.8	1972.09	1975.12	511	695	-	4	X	X	JM5355	1	+ resistor
<b>MINI COOPER</b>											
0.9	1964.09	1966.12	41	55	-	4	X	X	JM5355	1	+ resistor
1.0	1963.09	1964.12	49	67	-	4	X	X	JM5355	1	+ resistor

### AUSTIN-HEALEY USA

0.9	1958.01	1961.12	-	-	-	4	X	X	JM5455	1	+ resistor
2.6	1956.01	1959.12	-	-	-	6	X	X	JM5455	1	+ resistor
2.9	1959.01	1967.12	-	-	-	6	X	X	JM5455	1	+ resistor

### AVANTI USA

<b>AVANTI</b>											
4.6	2004.09	2007.12	224	305	-	8	-	-	JM5088	8	JM1193

### BENTLEY USA

<b>MULSANNE</b>											
6.7	1983.09	1992.12	164	223	-	8	X	X	JM5210	1	
6.8	1980.09	1981.12	164	223	-	8	X	X	JM5210	1	Extrenal resistance coil
6.8	1980.09	1981.12	164	223	-	8	X	X	JM5355	1	Internal resistance coil
6.8	1982.01	1987.12	164	223	-	8	X	X	JM5210	1	

### BMW USA

<b>BAVARIA</b>											
3.0	1971.09	1974.12	133	181	-	6	X	X	JM5455	1	+ resistor



<b>BUICK</b>											
<b>CENTURY</b>											
2.2	1991.10	1996.09	82	111	-	4	-/4	AM18	AMU18	JM5290	2
2.2 Special	1991.10	1996.12	87	118	LN2	4	-/4	AM18	AMU18	JM5290	2
2.5	1981.10	1986.09	66	90	-	4	-/4	AM19	AMU19	X	-
2.5	1988.01	1991.09	66	90	-	4	-/4	AM19	AMU19	JM5290	2
3.1	1991.10	1996.12	110	150	-	6	-/6	AM17	AMU17	JM5290	3
3.1	1993.10	1996.09	130	177	-	6	-/6	AM17	AMU17	JM5290	3
3.1	1996.10	2005.02	130	177	L82	6		X	X	JM5290	3
3.3	1986.10	1991.09	119	162	LG7	6	-/6	AM20	AMU20	X	-
3.8	1986.10	1988.09	94	128	LD5	6		X	X	JM5624	1 OE 12353801
3.8	1986.10	1988.09	94	128	LD5	6		X	X	JM5290	3 OE 10467067
3.8	1986.10	1988.09	103	140	LD5	6		X	X	JM5624	1 OE 12353801
3.8	1986.10	1988.09	103	140	LD5	6		X	X	JM5290	3 OE 10467067
3.8 Custom	1986.10	1988.09	112	152	LG3	6		X	X	JM5624	1 OE 12353801
3.8 Custom	1986.10	1988.09	112	152	LG3	6		X	X	JM5290	3 OE 10467067
3.8 T-Type	1986.10	1989.09	94	128	LN3	6		X	X	JM5624	1 OE 12353801
3.8 T-Type	1986.10	1989.09	94	128	LN3	6		X	X	JM5290	3 OE 10467067
3.8 T-Type	1986.10	1988.09	125	170	LD5	6		X	X	JM5624	1 OE 12353801
3.8 T-Type	1986.10	1988.09	125	170	LD5	6		X	X	JM5290	3 OE 10467067
<b>ELECTRA</b>											
3.8	1984.10	1985.09	103	140	LD5	6		X	X	JM5366	1 VIN (3); OE 1876209
3.8	1984.10	1985.09	123	167	LN3	6		X	X	JM5366	1 VIN (3); OE 1876209
3.8	1985.09	1986.09	103	140	LD5	6		X	X	JM5624	1 VIN (B); OE 12353801
3.8	1985.09	1986.09	103	140	LD5	6		X	X	JM5290	3 VIN (B); OE 10467067
3.8	1985.09	1987.12	112	152	LN3	6		X	X	JM5624	1 VIN (B); OE 12353801
3.8	1985.09	1987.12	123	167	LN3	6		X	X	JM5624	1 VIN (B); OE 12353801
3.8	1985.09	1987.12	123	167	LN3	6		X	X	JM5290	3 VIN (B); OE 10467067
3.8	1986.10	1987.12	92	125	LN3	6		X	X	JM5290	3 VIN (B); OE 10467067
3.8	1986.10	1987.12	121	165	LN3	6		X	X	JM5624	1 VIN (B); OE 12353801
3.8	1986.10	1987.12	121	165	LN3	6		X	X	JM5290	3 VIN (B); OE 10467067
3.8	1986.10	1989.09	123	167	LN3	6		X	X	JM5624	1 VIN (B); OE 12353801
<b>ELECTRA</b>											
3.8	1988.01	1990.09	92	125	LN3	6		X	X	JM5624	1 VIN (C); OE 12353801
3.8	1988.01	1989.09	92	125	LN3	6		X	X	JM5624	1 VIN (C); OE 12353801
3.8	1988.01	1990.09	121	165	LN3	6		X	X	JM5624	1 VIN (C); OE 12353801
<b>LE SABRE</b>											
3.8	1985.10	1986.09	103	140	LD5	6		X	X	JM5624	1 VIN (B); OE 12353801
3.8	1985.10	1986.09	112	152	LD5	6		X	X	JM5290	3 VIN (B); OE 10467067
3.8	1986.10	1987.09	112	152	LN3	6		X	X	JM5624	1 VIN (3); OE 12353801
3.8	1986.10	1987.09	112	152	LN3	6		X	X	JM5290	3 VIN (3); OE 10467067
3.8	1986.10	1987.09	123	167	LN3	6		X	X	JM5290	3 VIN (3); OE 10467067
3.8	1987.10	1988.12	121	165	LN3	6		X	X	JM5624	1 VIN (3); OE 12353801
3.8	1987.10	1988.12	121	165	LN3	6		X	X	JM5290	3 VIN (3); OE 10467067
3.8	1988.01	1991.09	121	165	LN3	6		X	X	JM5624	1 VIN (L); OE 12353801
3.8	1991.10	1992.12	127	173	L27	6	-/6	AM8	AMU8	JM5624	1 VIN (L); OE 12353801
3.8	1991.10	1995.09	127	173	L27	6	-/6	AM8	AMU8	JM5290	3 VIN (L); OE 10467067
3.8	1999.01	-->	153	208	L36	6		X	X	JM5290	3
<b>PARK AVENUE</b>											
3.8 Ultra	1990.10	1992.12	168	228	L67	6		X	X	JM5624	1 VIN (1), VIN (L) OE 12353801
3.8 Ultra	1990.10	1996.09	168	228	L67	6		X	X	JM5290	3 VIN (1), VIN (L) OE 10467067
3.8	1991.01	1992.12	127	173	L27	6	-/6	AM8	AMU8	JM5624	1 VIN (1), VIN (L) OE 12353801
3.8	1991.01	1996.10	127	173	L27	6	-/6	AM8	AMU8	JM5290	3 VIN (1), VIN (L) OE 10467067
3.8	1994.10	1996.10	150	204	L36	6		X	X	JM5290	3
3.8 Supercharged	1996.10	-->	179	243	L67	6		X	X	JM5290	3
<b>REGAL</b>											
2.8	1987.10	1989.09	97	132	LB6	6	-/6	AM16	AMU16	JM5290	3 VIN (W); OE 10467067
3.1	1988.10	1991.09	104	141	LH0	6	-/6	AM16	AMU16	JM5290	3 VIN (T); OE 10467067
3.1	1991.10	1993.09	101	137	LH0	6	-/6	AM16	AMU16	JM5290	3 VIN (T); OE 10467067
3.1	1993.10	1997.09	119	162	-	6	-/6	AM8	AMU8	JM5290	3
3.8	1989.10	1991.09	127	173	L27	6		X	X	JM5290	3
3.8	1991.10	1994.09	112	152	L27	6	-/6	AM8	AMU8	JM5290	3 VIN (L); OE 10467067
3.8	1991.10	1992.12	112	152	L27	6		X	X	JM5624	1 VIN (L); OE 12353801
3.8	1991.10	1992.12	127	173	L27	6		X	X	JM5624	1 VIN (L); OE 12353801





<b>BUICK</b>													
<b>REGAL</b>													
3.8	1991.10	1994.09	127	173	L27	6	-/6	AM8	AMU8	JM5290	3	VIN (L); OE 10467067	
3.8	1991.10	1992.12	150	204	L36	6		X	X	JM5624	1	VIN (L); OE 12353801	
3.8	1991.10	1997.09	150	204	L36	6		X	X	JM5290	3	VIN (L); OE 10467067	
<b>RENDEZVOUS</b>													
3.4 4x4	2000.04	2006.09	138	188	LA1	6		X	X	JM5290	3	VIN (E)	
<b>RIVERA</b>													
3.8	1990.01	1992.12	-	-	-	6	-/6	AM20	AMU20	X	-		
3.8	1992.01	-->	-	-	-	6	-/6	AM8	AMU8	X	-		
<b>ROADMASTER</b>													
5.0	1990.10	1992.09	127	173	-	8	1/8	AM34	AMU34	X	-		
5.7	1992.10	1993.09	135	184	-	8	1/8	AM34	AMU34	X	-		
5.7	1996.01	1996.12	132	180	-	8		X	X	JM5385	1	VIN (P)	
5.7	1996.01	1996.12	194	264	-	8		X	X	JM5385	1	VIN (P)	
<b>SKYLARK</b>													
2.3 Limited	1991.10	1993.09	86	117	L40 SOHC	4		X	-	JM5384	2	JM1189; Coil Cover OE 10475706; VIN (3)	
2.3	1993.10	1994.09	90	122	L40 SOHC	4		X	-	JM5384	2	JM1189; Coil Cover OE 10475706; VIN (3)	
2.3	1994.10	1995.09	119	162	LD24 DOHC	4		X	-	JM5384	2	JM1189; Coil Cover OE 10475706; VIN (D)	
2.4	1996.01	1998.12	112	152	LD9	4		X	-	JM5384	2	JM1189; Coil Cover OE 10475706; VIN (T)	
2.8	1979.04	1982.12	86	117	LE2	6	-/6	AM57	AMU57	X	-		
3.1	1994.01	1995.12	117	159	L82	6	-/6	AM8	AMU8	JM5290	3		
3.3 V6	1989.09	1993.09	119	162	LG7	6	-/6	AM20	AMU20	JM5290	3		
<b>BUICK USA</b>													
<b>ALLURE</b>													
3.6	2004.09	2008.12	179	243	-	6	-	-	-	JM5426	6	VIN (7)	
3.8	2004.09	2005.12	149	203	-	6		X	X	JM5290	3	VIN (2)	
3.8	2006.01	2009.12	149	203	-	6		X	X	JM5290	3	VIN (2)	
5.3	2007.09	2008.12	224	300	-	8		X	X	JM5406	8	system Mitsubishi	
5.3	2007.09	2008.12	224	300	-	8		X	X	JM5439	8	system Delphi	
<b>APOLLO</b>													
4.1 12V	1975.01	1975.12	75	102	-	6		X	X	JM5368	1	VIN (D)	
4.3 16V	1975.01	1975.12	84	114	-	8		X	X	JM5366	1	VIN (F)	
5.7	1974.01	1975.12	112	152	-	8		X	X	JM5366	1	VIN (H), VIN (J)	
5.7 16V	1975.01	1975.12	108	147	-	8		X	X	JM5366	1	VIN (H), VIN (J)	
<b>CENTURY</b>													
2.5	1982.01	1982.12	67	91	-	4		X	X	JM5368	1	VIN (5); USA	
2.5	1982.01	1982.12	67	91	-	4		X	X	JM5367	1	VIN (5); Canada	
2.5	1982.01	1986.12	67	91	-	4		X	X	JM5368	1	VIN (R)	
2.5	1982.01	1983.12	68	92	-	4		X	X	JM5368	1	VIN (R)	
2.5	1982.01	1983.12	68	92	-	4		X	X	JM5368	1	VIN (5); USA	
2.5	1982.01	1983.12	68	92	-	4		X	X	JM5367	1	VIN (5); Canada	
2.5	1982.01	1984.12	68	92	-	4		X	X	JM5368	1	VIN (R)	
2.5	1983.01	1983.12	67	91	-	4		X	X	JM5367	1	VIN (5)	
2.5	1984.01	1984.12	68	92	-	4		X	X	JM5368	1	VIN (R)	
2.5	1985.01	1986.12	69	94	-	4		X	X	JM5369	1	VIN (R)	
2.8	1982.09	1986.12	84	114	-	6		X	X	JM5368	1	VIN (X)	
2.8	1987.01	1989.12	84	114	-	6	-/6	AM16	AMU16	JM5290	3	VIN (W); OE 10467067	
2.8	1987.01	1989.12	94	127	-	6	-/6	AM16	AMU16	JM5290	3	VIN (W); OE 10467067	
3.8	1986.01	1988.12	93	127	-	6		X	X	JM5624	1	VIN (3); OE 12353801	
3.8	1986.01	1988.12	93	127	-	6		X	X	JM5290	3	VIN (3); OE 10467067	
3.8	1986.01	1988.12	112	152	-	6		X	X	JM5624	1	VIN (3); OE 12353801	
3.8	1986.01	1988.12	112	152	-	6		X	X	JM5290	3	VIN (3); OE 10467067	
4.4	1981.01	1981.12	90	122	-	8		X	X	JM5367	1	VIN (J)	
5.0 16V	1977.01	1980.12	108	147	-	8		X	X	JM5367	1	VIN (H), (U)	
5.7 16V	1977.01	1977.12	104	141	-	8		X	X	JM5367	1	VIN (H), (J), (L)	
5.7 16V	1977.01	1977.12	104	141	-	8		X	X	JM5367	1	VIN (R); Exc. California	
5.7 16V	1977.01	1977.12	104	141	-	8		X	X	JM5366	1	VIN (R); California	
5.7 16V	1978.01	1979.12	104	141	-	8		X	X	JM5367	1	VIN (L)	
<b>COMMERCIAL CHASSIS</b>													
5.7	1996.09	1996.12	134	182	-	8		X	X	JM5385	1		
<b>ELECTRA</b>													
3.8	1984.09	1985.12	95	129	-	6		X	X	JM5366	1	VIN (3); OE 1876209	
3.8	1986.01	1987.12	95	129	-	6		X	X	JM5624	1	VIN (B); OE 12353801	



<b>BUICK USA</b>												
<b>ELECTRA</b>												
3.8	1986.01	1987.12	95	129	-	6		X	X	JM5290	3	VIN (B); OE 10467067
3.8	1986.09	1987.12	112	152	-	6		X	X	JM5624	1	VIN (B); OE 12353801
3.8	1986.09	1987.12	112	152	-	6		X	X	JM5290	3	VIN (B); OE 10467067
3.8	1988.01	1990.12	95	129	-	6		X	X	JM5624	1	VIN (C);
<b>ENCLAVE</b>												
3.6	2009.01	2009.12	215	292	-	6	-	-	-	JM5426	6	VIN (D); OE 12566569
3.6 AWD	2009.01	2009.12	205	279	-	6	-	-	-	JM5426	6	VIN (D); OE 12566569
<b>LACROSSE</b>												
3.6	2004.09	2007.12	179	243	-	6	-	-	-	JM5426	6	VIN (7)
3.6	2007.09	2008.12	209	280	-	6	-	-	-	JM5426	6	VIN (7)
5.3	2007.09	2008.12	224	300	-	8		X	X	JM5406	8	VIN (C); sys. Mitsubishi
5.3	2007.09	2008.12	224	300	-	8		X	X	JM5439	8	VIN (C); system Delphi
5.3	2009.01	2009.12	224	300	-	8		X	X	JM5406	8	VIN (C); system Mitsubishi
5.3	2009.01	2009.12	224	300	-	8		X	X	JM5439	8	VIN (C); system Delphi
<b>LE SABRE</b>												
3.0	1985.09	1986.12	95	129	-	6		X	X	JM5624	1	VIN (L); OE 12353801
3.8	1985.09	1986.12	112	152	-	6		X	X	JM5624	1	VIN (B); OE 12353801
3.8	1985.09	1986.12	112	152	-	6		X	X	JM5290	3	VIN (B); OE 10467067
3.8	1985.09	1988.12	112	152	-	6		X	X	JM5624	1	VIN (3); OE 12353801
3.8	1985.09	1988.12	112	152	-	6		X	X	JM5290	3	VIN (3); OE 10467067
3.8	1988.01	1991.12	112	152	-	6		X	X	JM5624	1	VIN (C); OE 12353801
3.8	1988.01	1990.12	112	152	-	6		X	X	JM5624	1	VIN (C); OE 12353801
3.8	1991.09	1992.12	112	150	-	6		X	X	JM5624	1	VIN (L); OE 12353801
3.8	1991.09	1999.12	112	150	-	6		X	X	JM5290	3	VIN (L); OE 10467067
3.8	1999.09	2005.12	112	150	-	6		X	X	JM5290	3	VIN (L); OE 10467067
<b>LUCERNE</b>												
3.9	2008.09	2010.12	169	227	-	6		X	X	JM5496	1	VIN (1), VIN (M)
4.6	2005.09	2006.12	205	279	-	8	-	-	-	JM5440	8	VIN (Y); OE 12594176
4.6	2007.01	2007.12	205	279	-	8	-	-	-	JM5601	8	VIN (Y); OE 12597745
4.6	2007.09	2011.12	218	292	-	8	-	-	-	JM5601	8	VIN (9), VIN (S) OE 12597745
<b>PARK AVENUE</b>												
3.8	1990.09	1992.12	127	173	-	6		X	X	JM5624	1	VIN (1), VIN (L) OE 12353801
3.8	1990.09	1996.12	127	173	-	6		X	X	JM5290	3	VIN (1), VIN (L) OE 10467067
<b>RAINIER</b>												
4.2	2006.01	2007.12	205	275	-	6	-	-	-	JM5405	6	VIN (S)
5.3	2005.01	2006.12	224	300	-	8		X	X	JM5406	8	VIN (M); sys. Mitsubishi
5.3	2005.01	2006.12	224	300	-	8		X	X	JM5439	8	VIN (M); sys. Delphi
<b>REATA</b>												
3.8	1987.09	1990.12	123	167	-	6		X	X	JM5624	1	VIN (C) OE 12353801
3.8	1991.01	1991.12	123	167	-	6		X	X	JM5290	3	VIN (L); OE 10467067
<b>REGAL</b>												
2.0 FLEX AWD	2010.09	-->	164	220	-	4	-	-	-	JM5609	4	
2.4	2010.09	-->	136	182	-	4	-	-	-	JM5609	4	
2.4 FLEX	2011.09	-->	136	182	-	4	-	-	-	JM5609	4	
2.4 Hybrid	2011.09	-->	147	197	-	4	-	-	-	JM5609	4	
2.8	1987.09	1989.12	93	126	-	6	-/6	AM16	AMU16	JM5290	3	VIN (W); OE 10467067
3.1	1988.09	1993.12	104	141	-	6	-/6	AM16	AMU16	JM5290	3	VIN (T); OE 10467067
3.8	1984.01	1985.12	78	105	-	6		X	X	JM5624	1	VIN (1); OE 12353801
3.8	1984.01	1987.12	78	105	-	6		X	X	JM5366	1	VIN (A); OE 1876209
3.8	1986.01	1987.12	78	105	-	6		X	X	JM5624	1	VIN (7); OE 12353801
3.8	1992.01	1992.12	127	173	-	6		X	X	JM5624	1	VIN (L); OE 12353801
3.8	1992.01	1992.12	127	173	-	6		X	X	JM5290	3	VIN (L); OE 10467067
<b>RENDEZVOUS</b>												
3.4	2001.09	2005.12	138	188	-	6		X	X	JM5290	3	VIN (E)
3.5	2005.09	2007.12	146	199	-	6		X	X	JM5496	1	VIN (L)
3.6 / AWD	2003.09	2006.12	181	246	-	6	-	-	-	JM5426	6	VIN (7)
<b>RIVIERA</b>												
3.8	1983.09	1985.12	104	196	-	6		X	X	JM5624	1	VIN (9); OE 12353801
3.8	1986.09	1987.12	104	150	-	6		X	X	JM5624	1	VIN (3); OE 12353801
3.8	1986.09	1987.12	104	150	-	6		X	X	JM5290	3	VIN (3); OE 10467067
3.8	1987.09	1990.12	144	141	-	6		X	X	JM5624	1	VIN (C); OE 12353801



**BUICK USA**

<b>RIVIERA</b>													
3.8	1991.01	1994.12	112	141	-		6		X	X	JM5290	3	VIN (L); OE 10467067
3.8	1992.01	1992.12	112	141	-		6		X	X	JM5624	1	VIN (L); OE 12353801
3.8	1995.01	1997.12	104	141	-		6		X	X	JM5290	3	VIN (K); OE 10467067
3.8	1995.01	1999.12	104	141	-		6		X	X	JM5290	3	VIN (1); OE 10467067
<b>ROADMASTER</b>													
5.7	1996.01	1996.12	134	182	-		8		X	X	JM5385	1	VIN (P)
<b>SKYLARK</b>													
2.3	1991.09	1994.12	86	117	SOHC		4		-	-	JM5384	2	JM1189; VIN (3); Coil Cover OE 10475706
2.3	1994.09	1995.12	112	152	DOHC		4		-	-	JM5384	2	JM1189; VIN (D); Coil Cover OE 10475706
2.4	1995.09	1997.12	112	152	DOHC		4		-	-	JM5384	2	JM1189; VIN (T); Coil Cover OE 10475706
3.0	1985.09	1988.12	93	127	-		6		X	X	JM5624	1	VIN (L); OE 12353801
<b>SOMERSET</b>													
3.0	1986.01	1987.12	92	125	-		6		X	X	JM5624	1	VIN (L); OE 12353801
<b>TERRAZA</b>													
3.5	2004.09	2005.12	149	203	-		6		X	X	JM5496	1	VIN (L)
3.9	2005.09	2007.12	175	238	-		6		X	X	JM5496	1	VIN (1), VIN (W)
3.9 AWD	2005.09	2006.12	175	238	-		6		X	X	JM5496	1	VIN (1)
<b>VERANO</b>													
2.0 FLEX	2012.09	-->	186	253	-		4	-	-	-	JM5609	4	
2.4 FLEX	2011.09	-->	134	180	-		4	-	-	-	JM5609	4	OE 12638824

**CADILLAC**

<b>ALLANTE</b>													
4.5	1988.10	1992.09	150	204	LQ6		8	-/8	AM22	AMU22	JM5366	1	VIN (8)
4.5	1991.01	1992.09	150	204	LQ6		8	-/8	AM22	AMU22	JM5366	1	VIN (8)
4.6	1992.10	1993.09	220	299	L37		8		X	X	JM5290	4	
<b>BLS</b>													
2.0 T	2007.12	-->	129	175	Z 20 NET		4	-	-	-	JM5477	4	
2.8 T	2006.04	-->	188	255	B284L		6	-	-	-	JM5426	6	OE 12613057
2.8 T	2007.12	-->	188	255	Z 28 NET		6	-	-	-	JM5426	6	OE 12613057
2.8 T AWD	2008.10	-->	206	280	Z 28 NET		6	-	-	-	JM5426	6	OE 12613057
<b>BROUGHAM</b>													
5.0 V8	1990.01	-->	-	-	-		8	-/8	AM29	AMU29	X	-	
5.7 V8	1990.01	1992.12	-	-	-		8	1/8	AM34	AMU34	X	-	
<b>CATERA</b>													
3.0 i	1998.12	-->	147	-	Y30SE		6	-/6	AM56	AMU56	X	-	
<b>CTS</b>													
2.6	2002.03	2007.09	136	185	-		6	-	-	-	ODM260	1	right coil 1-3-5 cyl.
2.6	2002.03	2007.09	136	185	-		6	-	-	-	ODM261	1	left coil 2-4-6 cyl.
2.6	2003.04	2007.09	133	181	-		6	-	-	-	ODM260	1	right coil 1-3-5 cyl.
2.6	2003.04	2007.09	133	181	-		6	-	-	-	ODM261	1	left coil 2-4-6 cyl.
2.8	2005.03	2009.12	158	215	LP1		6	-	-	-	JM5426	6	OE 12613057
2.8	2008.01	2009.12	155	211	LP1		6	-	-	-	JM5426	6	OE 12629037
3.2	2002.03	2007.09	160	218	-		6	-	-	-	ODM260	1	right coil 1-3-5 cyl.
3.2	2002.03	2007.09	160	218	-		6	-	-	-	ODM261	1	left coil 2-4-6 cyl.
3.6	2005.03	2007.12	189	257	LY7		6	-	-	-	JM5426	6	OE 12613057
6.2	2008.01	-->	415	556	LSA		8		X	X	JM5406	8	sys. Mitsubishi; VIN (P)
6.2	2009.01	-->	415	556	LSA		8		X	X	JM5406	8	sys. Mitsubishi; VIN (P)
6.2	2011.09	-->	415	565	-		8		X	X	JM5406	8	sys. Mitsubishi; VIN (P)
<b>DEVILLE</b>													
4.5 V8	1990.01	-->	-	-	-		8	-/8	AM22	AMU22	X	-	
4.6 DHS	1999.10	2003.12	205	279	LD8		8	-	-	-	JM5504	1	VIN (9), VIN (Y); black
4.6 DHS	1999.10	2003.12	205	279	LD8		8	-	-	-	JM5505	1	VIN (9), VIN (Y); grey
4.6 DTS	1999.10	2003.12	224	305	L37		8	-	-	-	JM5504	1	VIN (9), VIN (Y); black
4.6 DTS	1999.10	2003.12	224	305	L37		8	-	-	-	JM5505	1	VIN (9), VIN (Y); grey
4.6 DHS	2004.01	2004.09	205	279	LD8		8	-	-	-	JM5503	2	VIN (9), VIN (Y)
4.6 DTS	2004.01	2004.09	224	305	L37		8	-	-	-	JM5503	2	VIN (9), VIN (Y)
4.9 Touring	1990.10	1993.09	149	203	-		8	-/8	AM22	AMU22	JM5290	4	
4.9	1993.10	1995.09	149	203	-		8	-/8	AM22	AMU22	JM5290	4	
<b>DTS</b>													
4.6	2005.06	2011.12	205	279	LD8		8	-	-	-	JM5601	8	OE 12597745
4.6	2005.06	2011.12	217	295	L37		8	-	-	-	JM5601	8	OE 12597745



## CADILLAC

ELDORADO											
4.5	1987.10	1989.09	115	156	-	8	-/8	AM22	AMU22	X	-
4.6	1993.10	1999.12	205	279	LD8	8		X	X	JM5290	4 VIN (9), VIN (Y)
4.6	1994.09	1999.12	224	305	L37, LD8	8		X	X	JM5290	4
4.6	2000.01	2002.09	205	279	LD8	8	-	-	-	JM5504	1 VIN (9), VIN (Y); black
4.6	2000.01	2002.09	205	279	LD8	8	-	-	-	JM5505	1 VIN (9), VIN (Y); grey
4.6	2000.01	2002.12	224	305	L37, LD8	8	-	-	-	JM5504	1 VIN (9), VIN (Y); black
4.6	2000.01	2002.12	224	305	L37, LD8	8	-	-	-	JM5505	1 VIN (9), VIN (Y); grey
4.9	1990.10	1991.09	149	203	-	8	-/8	AM22	AMU22	X	-
ESCALADE											
5.8	1998.10	2000.12	190	258	LO5	8	1/8	AM88	AMU88	JM5385	1 VIN (R)
6.0 4x4	2000.10	2002.01	257	349	LQ9	8		X	X	JM5473	8 sys. Mitsubishi; VIN (N)
6.0 4x4	2000.10	2002.01	257	349	LQ9	8		X	X	JM5442	8 sys. Delphi; VIN (N)
6.0	2001.06	2002.01	257	349	LQ9	8		X	X	JM5473	8 sys. Mitsubishi; VIN (N)
6.0	2001.06	2002.01	257	349	LQ9	8		X	X	JM5442	8 sys. Delphi; VIN (N)
6.0 HYBRID	2010.11	-->	248	337	-	8		X	X	JM5406	8 system Mitsubishi
6.0 HYBRID	2010.11	-->	248	337	-	8		X	X	JM5439	8 system Delphi
6.2	2006.10	2009.12	301	409	L92, L94	8		X	X	JM5406	8 sys. Mitsubishi; VIN (8)
6.2	2006.10	2009.12	301	409	L92, L94	8		X	X	JM5439	8 sys. Delphi; VIN (8)
6.2	2010.01	-->	301	409	L92, L94	8		X	X	JM5406	8 system Mitsubishi VIN (F)
6.2	2010.01	-->	301	409	L92, L94	8		X	X	JM5439	8 sys. Delphi; VIN (F)
FLEETWOOD											
5.7 Brougham	1996.01	1996.12	194	264	LT1	8		X	X	JM5385	1 VIN (P)
SEVILLE											
4.5 V8	1987.09	1988.12	134	182	-	8		X	X	JM5366	1 VIN (5)
4.5	1987.10	1989.09	115	156	-	8	-/8	AM22	AMU22	JM5366	1
4.5 V8	1989.01	1989.12	134	182	-	8		X	X	JM5366	1 VIN (5)
4.5 V8	1990.01	1990.09	134	182	-	8		X	X	JM5366	1 VIN (3)
4.6 SLS V8	1997.09	1999.12	205	279	LH2	8	-/8	AM86	AMU86	JM5290	4 VIN (9), VIN (Y)
4.6 STS V8	1997.09	1999.12	224	305	LH2	8	-/8	AM86	AMU86	JM5290	4 VIN (9), VIN (Y)
4.6 SLS V8	2000.01	2003.12	205	279	LH2	8	-	-	-	JM5504	1 VIN (9), VIN (Y); black
4.6 SLS V8	2000.01	2003.12	205	279	LH2	8	-	-	-	JM5505	1 VIN (9), VIN (Y); grey
4.6 STS V8	2000.01	2003.12	224	305	LH2	8	-	-	-	JM5504	1 VIN (9), VIN (Y); black
4.6 STS V8	2000.01	2003.12	224	305	LH2	8	-	-	-	JM5505	1 VIN (9), VIN (Y); grey
SEVILLE											
4.6	2000.10	2003.12	220	299	L37	8	-	-	-	JM5504	1 VIN (9), VIN (Y); black
4.6	2000.10	2003.12	220	299	L37	8	-	-	-	JM5505	1 VIN (9), VIN (Y); grey
4.6	2004.01	2004.09	220	299	L37	8	-	-	-	JM5503	2
4.6 SLS V8	2004.01	2004.09	205	279	LH2	8	-	-	-	JM5503	2 VIN (Y)
4.6 STS V8	2004.01	2004.09	224	305	LH2	8	-	-	-	JM5503	2 VIN (Y)
4.9	1990.10	1993.09	149	203	-	8	-/8	AM22	AMU22	JM5366	1
SRX											
3.6	2004.07	2006.08	190	258	LY7	6	-	-	-	JM5426	6 OE 12613057
4.6	2004.07	2006.12	239	325	LH2	8	-	-	-	JM5503	2 OE 12567285; VIN (A)
4.6	2006.01	2006.12	239	325	LH2	8	-	-	-	JM5440	8 OE 12594176; VIN (A)
4.6	2007.01	2008.12	239	325	LH2	8	-	-	-	JM5601	8 OE 12597745; VIN (A)
STS											
3.6	2005.05	-->	189	257	LY7	6	-	-	-	JM5426	6 OE 12613057
3.6	2009.10	-->	229	311	LLT	6	-	-	-	JM5426	6 OE 12613057
3.6 AWD	2009.10	-->	229	311	-	6	-	-	-	X	6 OE 12590990
4.4 Kompresor	2005.09	2009.12	350	476	LC3	8	-	-	-	JM5601	8 OE 12597745; VIN (D)
4.6	2005.05	2006.12	239	325	LH2	8	-	-	-	JM5503	2 OE 12567285; VIN (A)
4.6	2006.01	2009.12	239	325	LH2	8	-	-	-	JM5601	8 OE 12597745; VIN (A)
XLR											
4.4	2006.01	2009.09	331	450	LC3	8	-	-	-	JM5601	8 OE 12597745; VIN (D)
XRL											
4.6	2004.03	2006.12	240	326	-	8	-	-	-	JM5503	2 OE 12567285; VIN (A)
4.6	2006.01	2009.12	240	326	-	8	-	-	-	JM5601	8 OE 12597745; VIN (A)

## CADILLAC USA

ALLANTE											
4.1 16V	1987.01	1988.12	127	172	-	8		X	X	JM5366	1 VIN (7)
4.5 16V	1989.01	1992.12	149	203	-	8		X	X	JM5366	1 VIN (8)
BROUGHAM											
5.0 16V	1991.01	1992.12	104	141	-	8		X	X	JM5369	1 VIN (E)
5.7 16V	1990.01	1992.12	132	180	-	8		X	X	JM5369	1 VIN (7)

**CADILLAC USA**

CADILLAC USA											
<b>CALAIS</b>											
7.7	1974.01	1974.12	153	208	-	8		X	X	JM5367	1 VIN (R)
8.2 16V	1975.01	1976.12	142	193	-	8		X	X	JM5367	1 CARB.; VIN (S)
8.2 16V	1975.01	1976.12	142	193	-	8		X	X	JM5367	1 INJ.; VIN (S)
<b>CIMARRON</b>											
1.8 8V	1982.01	1982.12	66	90	-	4		X	X	JM5368	1 VIN (G)
2.0 8V	1983.01	1984.12	66	90	-	4		X	X	JM5368	1 VIN (P)
<b>COMMERCIAL CHASSIS</b>											
5.7	1996.01	1996.12	138	188	-	8		X	X	JM5385	1
<b>CTS</b>											
2.8	2004.09	2005.12	157	214	-	6	-	-	-	JM5426	6 OE 12613057; VIN (T)
2.8	2005.09	2007.12	157	214	-	6	-	-	-	JM5426	6 OE 12613057; VIN (T)
3.6	2003.09	2005.12	190	258	-	6	-	-	-	JM5426	6 VIN (7)
3.6	2007.09	2011.12	201	270	-	6	-	-	-	X	6 OE 12590990
3.6	2009.09	2010.12	227	304	-	6	-	-	-	X	6 OE 12590990
3.6 FLEX	2011.09	-->	237	318	-	6		X	X	X	6 OE 12590990
6.0	2005.09	2007.12	298	405	-	8		X	X	JM5406	8 sys. Mitsubishi; VIN (U)
6.0	2005.09	2007.12	298	405	-	8		X	X	JM5439	8 sys. Delphi; VIN (U)
6.2	2008.09	-->	415	556	-	8		X	X	JM5406	8 system Mitsubishi VIN (P)
<b>DEVILLE</b>											
4.6	1996.09	1999.12	205	279	-	8		X	X	JM5290	4 VIN (9), VIN (Y)
4.6	1999.09	2003.12	201	270	-	8		-	-	JM5504	1 VIN (9), VIN (Y); black
4.6	1999.09	2003.12	201	270	-	8		-	-	JM5505	1 VIN (9), VIN (Y); grey
4.6	1999.09	2003.12	205	275	-	8		-	-	JM5504	1 VIN (9), VIN (Y); black
4.6	1999.09	2003.12	205	275	-	8		-	-	JM5505	1 VIN (9), VIN (Y); grey
4.6	2004.01	2005.12	201	270	-	8		-	-	JM5503	2 VIN (9), VIN (Y)
4.6	2004.01	2004.12	205	279	-	8	-	-	-	JM5503	2 VIN (9), VIN (Y)
<b>DTS</b>											
4.6	2005.09	2006.12	205	279	-	8	-	-	-	JM5601	8 VIN (Y), VIN (9) OE 12597745
4.6	2006.09	2007.12	205	279	-	8	-	-	-	JM5601	8 VIN (Y), VIN (9) OE 12597745
4.6	2007.09	2011.12	218	292	-	8	-	-	-	JM5601	8 VIN (Y), VIN (9) OE 12597745
<b>ELDORADO</b>											
4.6	1992.09	1999.12	201	273	-	8		X	X	JM5290	4 VIN (9), VIN (Y)
4.6	2000.01	2002.12	201	273	-	8	-	-	-	JM5504	1 VIN (9), VIN (Y); black
4.6	2000.01	2002.12	201	273	-	8	-	-	-	JM5505	1 VIN (9), VIN (Y); grey
<b>ESCALADE</b>											
5.3	2001.09	2005.12	213	290	-	8		X	X	JM5473	8 sys. Mitsubishi; VIN (T)
5.3	2001.09	2005.12	213	290	-	8		X	X	JM5442	8 sys. Delphi; VIN (T)
5.7	1998.09	2000.12	193	262	-	8	1/8	AM88	AMU88	JM5385	1 VIN (R)
6.0	2001.09	2006.12	261	355	-	8		X	X	JM5473	8 sys. Mitsubishi; VIN (N)
6.0	2001.09	2006.12	261	355	-	8		X	X	JM5442	8 sys. Delphi; VIN (N)
6.0	2001.09	2002.12	257	350	-	8		X	X	JM5473	8 sys. Mitsubishi; VIN (N)
6.0	2001.09	2002.12	257	350	-	8		X	X	JM5442	8 sys. Delphi; VIN (N)
6.0 AWD	2001.09	2006.12	257	350	-	8		X	X	JM5473	8 sys. Mitsubishi; VIN (N)
6.0 AWD	2001.09	2006.12	257	350	-	8		X	X	JM5442	8 sys. Delphi; VIN (N)
6.0	2009.01	2009.12	-	-	-	8		X	X	JM5406	8 sys. Mitsubishi; VIN (5)
6.0	2009.01	2009.12	-	-	-	8		X	X	JM5439	8 sys. Delphi; VIN (5)
6.0	2010.01	-->	-	-	-	8		X	X	JM5406	8 sys. Mitsubishi; VIN (J)
6.0	2010.01	-->	-	-	-	8		X	X	JM5439	8 sys. Delphi; VIN (J)
6.0	2011.09	-->	248	332	-	8		X	X	JM5406	8 system Mitsubishi
6.0	2011.09	-->	248	332	-	8		X	X	JM5439	8 system Delphi
6.2 AWD	2006.09	2010.12	301	409	-	8		X	X	JM5406	8 sys. Mitsubishi; VIN (8)
6.2 AWD	2006.09	2010.12	301	409	-	8		X	X	JM5439	8 sys. Delphi; VIN (8)
6.2 Flexfuel AWD	2008.09	2009.12	239	320	-	8		X	X	JM5406	8 sys. Mitsubishi; VIN (2)
6.2 Flexfuel AWD	2008.09	2009.12	239	320	-	8		X	X	JM5439	8 sys. Delphi; VIN (2)
6.2 Flexfuel AWD	2008.09	2011.12	239	320	-	8		X	X	JM5406	8 sys. Mitsubishi; VIN (F)
6.2 Flexfuel AWD	2008.09	2011.12	239	320	-	8		X	X	JM5439	8 sys. Delphi; VIN (F)
6.2 Flexfuel AWD	2009.09	2010.12	248	332	-	8		X	X	JM5406	8 sys. Mitsubishi; VIN (F)
6.2 Flexfuel AWD	2009.09	2010.12	248	332	-	8		X	X	JM5439	8 sys. Delphi; VIN (F)
6.2 FLEX	2011.09	-->	300	403	-	8		X	X	JM5406	8 system Mitsubishi
6.2 FLEX	2011.09	-->	300	403	-	8		X	X	JM5439	8 system Delphi
6.2 FLEX AWD	2011.09	-->	301	409	-	8		X	X	JM5406	8 system Mitsubishi
6.2 FLEX AWD	2011.09	-->	301	409	-	8		X	X	JM5439	8 system Delphi



## CADILLAC USA

FLEETWOOD												
5.7	1992.09	1996.12	138	188	-	8		X	X	JM5385	1	VIN (P)
LACROSSE												
2.4	2009.09	-->	136	182	-	4	-	-	-	JM5609	4	OE 12638824
2.4 Hybrid AWD	2011.09	-->	136	182	-	4	-	-	-	JM5609	4	OE 12638824
SEVILLE												
4.6	1997.09	1999.12	201	270	-	8	-/8	AM86	AMU86	JM5290	4	VIN (9), VIN (Y)
4.6	1997.09	2003.12	201	270	-	8	-	-	-	JM5505	1	VIN (9), VIN (Y); grey
4.6	2000.01	2003.12	201	270	-	8	-	-	-	JM5504	1	VIN(9),VIN(Y); black
4.6	2004.01	2004.12	201	270	-	8	-	-	-	JM5503	2	VIN (Y)
SRX												
3.6	2003.09	2006.12	190	258	-	6	-	-	-	JM5426	6	OE 12613057
4.6	2003.09	2006.12	239	325	-	8	-	-	-	JM5503	2	OE 12567285; VIN (A)
4.6	2007.01	2007.12	239	325	-	8	-	-	-	JM5601	8	OE 12597745; VIN (A)
STS												
3.6 AWD	2004.09	2005.12	190	258	-	6	-	-	-	JM5426	6	OE 12613057
3.6 AWD	2007.09	2009.12	229	307	-	6	-	-	-	JM5426	6	OE 12613057
4.4 V	2005.09	2007.12	355	483	-	8	-	-	-	JM5601	8	OE 12597745; VIN (D)
4.6 AWD	2004.09	2005.12	239	325	-	8	-	-	-	JM5503	2	VIN (A)
4.6	2007.09	2010.12	225	302	-	8	-	-	-	JM5601	8	OE 12597745; VIN (A)
4.6	2007.09	2009.12	350	469	-	8	-	-	-	JM5601	8	OE 12597745; VIN (A)
4.6 AWD	2007.09	2011.12	239	325	-	8	-	-	-	JM5601	8	OE 12597745; VIN (A)
XLR												
4.4 V	2005.09	2007.12	336	457	-	8	-	-	-	JM5601	8	OE 12597745; VIN (D)
4.4 V	2007.09	2009.12	331	443	-	8	-	-	-	JM5601	8	OE 12597745; VIN (D)
4.6	2003.09	2005.12	239	325	-	8	-	-	-	JM5503	2	VIN (A)
4.6	2007.09	2009.12	239	325	-	8	-	-	-	JM5601	8	OE 12597745; VIN (A)

## CHECKER USA

MARATHON												
3.8 12V	1980.01	1982.12	82	112	-	6		X	X	JM5366	1	
4.1 12V	1975.01	1977.12	78	106	-	6		X	X	JM5368	1	
4.1 12V	1978.01	1979.12	78	106	-	6		X	X	JM5367	1	
4.4 16V	1980.01	1982.12	86	117	-	8		X	X	JM5367	1	
5.0 16V	1977.01	1982.12	108	147	-	8		X	X	JM5367	1	
5.7 16V	1975.01	1979.12	123	167	-	8		X	X	JM5367	1	

## CHEVROLET

200 - series												
250 cu.in	1969.01	1975.12	-	-	-	6		X	X	JM5334	1	GT40RT
283 cu.in	1955.01	1975.12	-	-	-	8		X	X	JM5334	1	GT40RT
300 - series												
307 / 327 / 350 / 396 cu.in	1955.01	1975.12	-	-	-	8		X	X	JM5334	1	GT40RT
AGILE												
1.4	2009.10	-->	68	92	-	4		X	X	JM5618	1	5-PINS; OE 94702536
1.4 Flex	2009.10	-->	71	97	-	4		X	X	JM5618	1	5-PINS; OE 94702536
ALERO												
2.4 16V	1999.03	2004.09	104	141	LD9	4		X	-	JM5384	2	JM1189; Coil Cover OE 10475706 VIN (T); DOHC
ASTRO												
4.3	1985.10	1994.09	119	162	LB4	6	1/6	AM83	AMU83	JM5369	1	
4.3 Luxury	1986.10	1989.09	119	162	LB4	6	1/6	AM83	AMU83	JM5369	1	
4.3 AWD	1989.10	1994.09	107	146	LB4	6	1/6	AM83	AMU83	JM5369	1	
4.3	1992.04	1994.09	112	152	LB4	6	1/6	AM83	AMU83	JM5369	1	
4.3	1994.10	1995.09	127	173	LF6	6	1/6	AM83	AMU83	JM5369	1	
4.3	1994.10	1995.12	142	193	LB4	6	1/6	AM83	AMU83	JM5369	1	
4.3	1996.01	2005.05	142	193	LB4	6		X	X	JM5385	1	
AVALANCHE												
5.3	2000.10	2006.09	220	299	LM7	8		X	X	JM5473	8	sys. Mitsubishi VIN (T), VIN (Z)
5.3	2000.10	2006.09	220	299	LM7	8		X	X	JM5442	8	sys. Delphi VIN (T), VIN (Z)
5.3 AWD	2006.05	2009.12	235	320	LY5	8		X	X	JM5406	8	sys. Mitsubishi; VIN (0), VIN (3), VIN (J)
5.3 AWD	2006.05	2009.12	235	320	LY5	8		X	X	JM5439	8	sys. Delphi; VIN (0), VIN (3), VIN (J)
5.3 Flex-Fuel AWD	2007.01	2009.12	227	309	-	8		X	X	JM5406	8	sys. Mitsubishi; VIN (0), VIN (3), VIN (J)



CHEVROLET												
<b>AVALANCHE</b>												
5.3 Flex-Fuel AWD	2007.01	2009.12	227	309	-	8		X	X	JM5439	8	sys. Delphi; VIN (0), VIN (3), VIN (J)
5.3 AWD	2011.01	2011.12	235	320	LY5	8		X	X	JM5406	8	sys. Mitsubishi; VIN (3)
5.3 AWD	2011.01	2011.12	235	320	LY5	8		X	X	JM5439	8	sys. Delphi; VIN (3)
8.1 AWD	2003.01	2006.09	253	344	L18	8		X	X	JM5473	8	VIN (G)
<b>AVEO</b>												
1.2	2006.03	2007.12	53	72	F12S3	4	-/4	AM48	AMU48	JM5079	1	
1.2	2006.03	-->	56	76	B12S1	4		X	X	JM5079	1	
1.2	2008.04	-->	55	75	B12D1	4	-/4	AM48	AMU48	JM5079	1	
1.2	2008.04	-->	62	84	B12D1	4	-/4	AM48	AMU48	JM5079	1	
1.2	2008.04	-->	62	84	B12D1	4	-/4	AM92	AMU92	JM5079	1	
1.2	2011.03	-->	51	69	A 12 XEL	4	-/4	AM92	AMU92	JM5079	1	
1.2	2011.03	-->	63	86	A 14 XER	4	-/4	AM92	AMU92	JM5079	1	
1.4	2006.03	2007.12	69	94	F14D3	4	-/4	AM44	AMU44	JM5079	1	
1.4	2008.01	-->	74	101	F14D4	4	-/4	AM44	AMU44	JM5079	1	
1.4 CNG	2010.01	-->	69	94	L95	4		X	X	JM5079	1	
1.4	2011.03	-->	74	101	A 14 XER	4		X	X	JM5079	1	
1.5	2005.05	-->	62	84	F15S3	4	-/4	AM44	AMU44	JM5079	1	
1.6	2004.12	2006.09	77	105	A16DMS	4		X	X	JM5079	1	
1.6	2005.05	-->	76	103	F16D3, LXV	4		X	X	JM5079	1	
1.6	2006.03	-->	75	102	A16DMS	4		X	X	JM5079	1	
1.6	2008.01	2008.12	77	105	LXV	4		X	X	JM5079	1	OE 96253555
<b>BERETTA</b>												
2.2	1991.01	1996.12	71	97	LN2	4	-/4	AM23	AMU23	JM5290	2	
2.2	1991.10	1992.09	82	112	LN2	4		X	X	JM5290	2	
2.2	1992.10	1996.09	87	118	LN2	4	-/4	AM18	AMU18	JM5290	2	
2.3 16V	1990.09	1996.12	130	177	LGO	4		X	-	JM5384	2	JM1189; Coil Cover OE 10475706 VIN (A); DOHC
2.3	1992.10	1996.09	134	182	LGO	4		X	-	JM5384	2	JM1189; Coil Cover OE 10475706 VIN (A); DOHC
3.1 V6	1987.04	1996.12	104	141	LHO	6	-/6	AM17	AMU17	JM5290	3	
3.1 LT	1992.10	1993.09	103	140	LHO	6		X	X	JM5290	3	
3.1	1993.10	1996.09	110	150	L82	6	-/6	AM8	AMU8	JM5290	3	
3.1 Z26	1993.10	1996.09	119	162	L82	6	-/6	AM8	AMU8	JM5290	3	
<b>BLAZER</b>												
4.3	1988.09	1994.08	115	156	LB4	6	1/6	AM83	AMU83	X	-	
4.3	1994.10	1995.09	119	162	LB4	6	1/6	X	X	JM5369	1	Dist. Horizontal Coil 2 -2 terminal plugs
4.3	1994.10	1995.09	119	162	LB4	6	1/6	AM83	AMU83	JM5369	1	Dist. Vertical Coil 2 -2 terminal plugs
4.3	1994.10	1995.09	119	162	LB4	6	1/6	AM83	AMU83	X	-	Dist. Vertical Coil 2 -1 terminal plug
4.3 V6 4x4	1995.01	1995.12	142	193	L35	6	1/6	AM83	AMU83	JM5369	1	Dist. Vertical Coil 2 -2 terminal plugs
4.3 V6 4x4	1995.01	1995.12	142	193	L35	6	1/6	AM83	AMU83	X	1	Dist. Vertical Coil 2 -1 terminal plug
4.3 AWD	1995.10	1998.09	127	173	LF6	6	1/6	AM87	AMU87	JM5385	1	VIN (W)
4.3 V6 4x4	1996.01	2005.09	142	193	L35	6	1/6	AM87	AMU87	JM5385	1	
<b>C series</b>												
C20, C30, C50, C60	1975.01	1975.12	-	-	-	6		X	X	JM5334	1	for BOSCH GT40T R1=3.0[Ω], R2=8.5[kΩ]
<b>C1500</b>												
4.3 AWD	1991.10	1996.09	119	162	LB4	6	1/6	AM83	AMU83	X	-	
4.3	1996.10	1999.09	149	203	LB4	6		X	X	JM5385	1	
<b>C2500</b>												
4.3	1991.10	1996.09	119	162	LB4	6	1/6	AM83	AMU83	X	-	
5.7	1996.10	1996.09	157	214	LO5	8		X	X	JM5385	1	VIN (R)
5.7 RC	1996.10	2000.04	186	253	L31	8		X	X	JM5385	1	VIN (R)
<b>CAMARO</b>												
3.1	1989.10	1992.09	103	140	LHO	6	1/6	AM14	AMU14	X	-	
3.4	1992.12	1998.07	119	162	-	6	-/6	AM20	AMU20	JM5290	3	
3.8	1995.10	1997.09	149	203	L36	6	-/6	AM26	AMU26	JM5290	3	
3.8	1998.07	2002.12	142	193	L36	6		X	X	JM5290	3	
5.0	1987.10	1992.09	127	173	-	8	1/8	AM34	AMU34	X	-	
5.7	1984.10	1992.09	168	228	L98	8	1/8	AM34	AMU34	X	-	
5.7	1992.12	1998.07	205	279	LT1	8	1/8	AM24	AMU24	JM5385	1	
5.7	1996.01	1997.12	205	279	LT1	8	1/8	AM36	AMU36	X	1	VIN (P)



<b>CHEVROLET</b>												
<b>CAMARO</b>												
5.7	1996.01	1997.09	207	282	LT1	8	1/8	AM36	AMU36	X	1	VIN (P)
5.7	1998.07	2002.12	212	288	LS1	8		X	X	JM5290	4	
6.2	2011.01	-->	298	405	L99	8		X	X	JM5406	8	system Mitsubishi VIN (J), VIN (W)
6.2	2011.01	-->	298	405	L99	8		X	X	JM5439	8	system Delphi VIN (J), VIN (W)
6.2	2011.01	-->	318	432	LS3	8		X	X	JM5406	8	system Mitsubishi VIN (J), VIN (W)
6.2	2011.01	-->	318	432	LS3	8		X	X	JM5439	8	system Delphi VIN (J), VIN (W)
<b>CAPRICE</b>												
4.3	1984.10	1989.09	119	162	LB4	6	1/6	AM28	AMU28	X	-	
4.3	1986.10	1989.09	106	144	-	6	1/6	AM28	AMU28	X	-	
4.3	-->	1994.12	-	-	-	6	-/6	AM26	AMU26	X	-	
4.3	1996.01	1996.09	149	203	L9943	8		X	X	JM5385	1	VIN (W)
5.0	1982.10	1986.09	114	155	LG4	8	-/8	AM29	AMU29	X	-	
5.0	1984.10	1986.09	110	150	LG4	8	-/8	AM29	AMU29	X	-	
5.0	1986.10	1989.09	104	141	-	8	-/8	AM29	AMU29	X	-	
5.0 Brougham	1986.10	1988.09	110	150	LG4	8	-/8	AM29	AMU29	JM5290	4	
5.0	1987.10	1990.09	100	136	-	8	-/8	AM29	AMU29	X	-	
5.0	1990.10	1993.09	127	173	-	8	1/8	AM34	AMU34	X	-	
5.0 Turbo	1990.10	1993.09	170	231	-	8	1/8	AM34	AMU34	X	-	
5.7	1990.10	1993.09	138	188	-	8	1/8	AM34	AMU34	X	-	
5.7	1993.10	1996.09	183	249	LT1	8		X	X	JM5385	1	
5.7	1993.10	1996.09	194	264	-	8	1/4	AM25	AMU25	X	-	
5.7	1996.01	1996.09	194	264	LT1	8		X	X	JM5385	1	VIN (P)
5.7	1996.01	1996.09	207	282	LT1	8		X	X	JM5385	1	VIN (P)
<b>CAPTIVA</b>												
2.4 4WD	2006.06	-->	100	136	Z 24 SED	4	-/4	AM45	AMU45	X	-	
2.4 LPG	2007.01	-->	100	136	S 24 SED	4	-/4	AM45	AMU45	JM5079	1	OE 96253555
2.4	2012.01	-->	136	185	LAF	4	-	-	-	JM5609	4	OE 12638824
3.2 V6	2006.06	-->	169	230	10 HM	6	-	-	-	X	6	
<b>CAVALIER</b>												
2.2	1989.10	1991.09	71	97	-	4	-/4	AM21	AMU21	X	-	
2.2 RS	1991.10	1996.09	90	122	LN2	4	-/4	AM18	AMU18	JM5290	2	
2.3	1995.10	1995.12	112	152	LD2	4		X	-	JM5384	2	JM1189; Coil Cover OE 10475706; VIN (D)
3.1	1989.10	1991.09	103	140	LHO	6	-/6	AM17	AMU17	JM5290	3	
3.1	1991.10	1994.09	103	140	LHO	6	-/6	AM17	AMU17	JM5290	3	
<b>CELEBRITY</b>												
2.5	-->	1990.12	-	-	-	4	-/4	AM19	AMU19	X	-	
3.1 V6	-->	1990.12	-	-	-	6	1/6	AM9	AMU9	X	-	
<b>CHEVY</b>												
1.6	2000.09	2003.12	58	79	-	4		X	X	JM5038	1	Mexico
<b>C-K series</b>												
4.3	1988.09	1994.09	106	144	-	6	1/6	AM30	AMU30	X	-	
5.0 V8	-->	1995.12	-	-	-	8	1/8	AM31	AMU31	X	-	
5.7	1987.10	1995.09	157	214	LO5	8	1/8	AM31	AMU31	X	-	
5.7	1996.10	2000.04	190	258	-	8	1/8	AM88	AMU88	X	-	
7.4 V8	1987.10	1995.09	170	231	L19	8	1/8	AM34	AMU34	X	-	
7.4	1994.10	1999.09	170	231	-	8	1/8	AM32	AMU32	X	-	
<b>COBALT</b>												
2.0	2005.07	2007.12	152	207	LSJ	4	-	-	-	JM5478	4	VIN (P)
2.0	2008.01	2010.12	152	207	LSJ	4	-	-	-	JM5609	4	OE 12638824
2.2	2007.01	2010.12	108	147	L61	4	-	-	-	JM5609	4	OE 12638824
2.4	2006.01	2008.12	128	174	LE5	4	-	-	-	JM5609	4	OE 12638824
<b>COLORADO</b>												
2.9	2006.10	-->	139	189	LLV	4	-	-	-	JM5405	4	VIN (9)
3.7	2006.10	-->	181	246	L5R	5	-	-	-	JM5405	5	VIN (E)
<b>CORSA</b>												
1.4 Flex	2007.06	-->	77	105	X 14 YEH	4		X	X	JM5618	1	5-PINS; OE 94702536
<b>CORSICA</b>												
2.2	1991.01	1996.12	71	97	LN2	4	-/4	AM23	AMU23	JM5290	2	
2.2	1994.01	1996.12	82	112	LN2	4	-/4	AM18	AMU18	JM5290	2	
2.3 GTZ	1989.10	1992.09	134	182	LGO	4		X	X	JM5290	2	
2.8	1987.02	1989.09	93	126	-	6	1/6	AM9	AMU9	JM5290	3	
3.1 V6	1987.04	1996.12	104	141	LHO	6		X	X	JM5290	3	





CHEVROLET												
<b>CORSICA</b>												
3.1 LT	1989.10	1992.09	106	144	-	6	-/6	AM17	AMU17	JM5290	3	
3.1	1992.10	1996.09	95	129	L82	6	-/6	AM8	AMU8	JM5290	3	
3.1 LT	1992.10	1996.09	110	150	L82	6	-/6	AM8	AMU8	JM5290	3	
3.1 LT	1992.10	1996.09	119	162	L82	6	-/6	AM8	AMU8	JM5290	3	
<b>CORVETTE</b>												
5.7	1989.10	1991.09	186	253	-	8	-/8	AM27	AMU27	X	-	
5.7	1991.10	1995.12	207	281	LT1	8		X	X	JM5290	4	VIN (J)
5.7	1991.10	1995.12	207	281	LT1	8	1/8	AM24	AMU24	JM5369	1	VIN (P)
5.7	1991.10	1997.04	224	305	-	8	1/8	AM24	AMU24	X	-	
5.7 Grand Sport	1995.10	1997.04	246	334	LT5	8		X	X	JM5385	1	VIN (5); 6 MTM
5.7	1996.01	1996.12	207	281	LT1	8		X	X	JM5385	1	VIN (P)
5.7	1996.01	1997.04	224	305	LT1	8		X	X	JM5385	1	VIN (P)
5.7	1996.01	1997.01	182	248	L98	8		X	X	JM5385	1	VIN (P)
5.7 Grand Sport	1996.01	1997.04	279	379	LT5	8		X	X	JM5385	1	VIN (P)
6.0	2004.09	2007.12	298	405	LS2	8		X	X	JM5406	8	sys. Mitsubishi; VIN (U)
6.0	2004.09	2007.12	298	405	LS2	8		X	X	JM5439	8	sys. Delphi; VIN (U)
6.2	2006.03	2009.12	316	430	LS3	8		X	X	JM5406	8	sys. Mitsubishi; VIN (W)
6.2	2006.03	2009.12	316	430	LS3	8		X	X	JM5439	8	sys. Delphi; VIN (W)
6.2 LS3	2008.02	-->	321	437	LS3	8		X	X	JM5406	8	system Mitsubishi
6.2 LS3	2008.02	-->	321	437	LS3	8		X	X	JM5439	8	system Delphi
6.2 ZR1	2008.09	-->	476	638	LS9 (6,2L)	8		X	X	JM5406	8	system Mitsubishi
6.2 ZR1	2008.09	-->	476	638	LS9 (6,2L)	8		X	X	JM5439	8	system Delphi
7.0	2006.03	2009.12	371	498	-	8		X	X	JM5406	8	sys. Mitsubishi; VIN (E)
7.0	2006.03	2009.12	371	498	-	8		X	X	JM5439	8	sys. Delphi; VIN (E)
7.0	2006.03	2009.12	377	512	LS7	8		X	X	JM5406	8	sys. Mitsubishi; VIN (E)
7.0	2006.03	2009.12	377	512	LS7	8		X	X	JM5439	8	sys. Delphi; VIN (E)
<b>CRUZE</b>												
1.6	2009.05	-->	80	109	F16D3, LXT, LXV	4		X	X	JM5079	1	
1.8	2009.05	-->	104	141	2H0	4	-	-	-	JM5500	1	
<b>EPICA</b>												
2.0	2006.06	-->	105	144	-	6	-	-	-	JM5282	6	
2.5	2006.06	-->	115	156	-	6	-	-	-	JM5282	6	
<b>EQUINOX</b>												
3.4	2003.04	2009.09	138	188	LNJ	6		X	X	JM5496	1	VIN (F)
<b>EVANDA</b>												
2.0	2005.03	-->	96	131	X20SED	4	-/4	AM45	AMU45	JM5079	1	
<b>G series</b>												
4.3	1986.09	1992.12	119	162	-	6	1/6	AM30	AMU30	X	-	
4.3	1993.10	1996.12	121	165	-	6	-/6	AM33	AMU33	X	-	
5.0	1986.09	1995.12	130	177	-	8	1/8	AM31	AMU31	X	-	
5.7	1989.09	1995.12	149	203	-	8	1/8	AM31	AMU31	X	-	
5.7	1995.10	2006.12	145	197	-	8		X	X	JM5369	1	
7.4	1987.09	1996.12	172	234	-	8	1/8	AM34	AMU34	X	-	
7.4	1993.10	1996.12	176	239	L29	8	1/8	AM32	AMU32	X	-	
<b>HHR</b>												
2.2	2006.01	-->	108	147	L61	4	-	-	-	JM5609	4	OE 12638824
2.4	2006.01	-->	128	174	LE5	4	-	-	-	JM5609	4	OE 12638824
2.4	2007.10	-->	125	170	-	4	-	-	-	JM5609	4	OE 12638824
<b>IMPALA</b>												
3.4 V6	1999.01	2005.12	134	182	LA1	6		X	X	JM5290	3	
3.8 V6	1999.01	2005.12	149	203	L36	6		X	X	JM5290	3	
4.3 V8	1994.01	1996.12	-	-	-	8	1/4	AM25	AMU25	X	-	
5.7	1993.09	1996.12	194	264	-	8	1/4	AM25	AMU25	X	-	
<b>KALOS</b>												
1.2	2005.03	-->	53	72	B12S1	4	-/4	AM48	AMU48	JM5079	1	
1.2	2005.03	-->	53	72	F12S3	4	-/4	AM48	AMU48	JM5079	1	
1.4	2005.03	-->	61	83	F14S3	4		X	X	JM5079	1	
1.4 16V	2005.03	-->	69	94	F14D3	4		X	X	JM5079	1	
<b>LACETTI</b>												
1.4 16V	2005.03	-->	70	95	F14D3	4	-/4	AM46	AMU46	JM5220	1	
1.6	2005.03	-->	80	109	F16D3	4	-/4	AM46	AMU46	JM5220	1	
1.8	2005.03	-->	90	122	T18SED	4	-	-	-	JM5500	1	
1.8	2005.03	2006.01	90	122	T18SED	4	-/4	AM45	AMU45	JM5079	1	
1.8	2005.08	-->	89	121	F18D3	4	-	-	-	JM5500	1	
1.8	2005.08	2006.01	89	121	F18D3	4	-/4	AM45	AMU45	JM5079	1	



<b>CHEVROLET</b>												
<b>LE SABRE</b>												
3.8	1995.10	1999.09	153	208	L36	6		X	X	JM5290	3	OE 10467067
<b>LOVA</b>												
1.4	2005.08	-->	61	83	F14S3	4		X	X	JM5079	1	
1.4	2005.08	-->	69	94	F14D3	4		X	X	JM5079	1	
1.6	2005.08	-->	78	106	A16DMS	4		X	X	JM5079	1	
<b>LUMINA</b>												
2.3	1992.12	1996.07	108	147	LD2	4		X	X	JM5290	2	
2.3	1993.10	1996.07	101	137	-	4		X	X	JM5290	2	
2.5	1989.10	1992.09	82	112	LR8	4		X	X	JM5290	2	
3.1	1989.08	1996.07	90	122	LG6	6	1/6	AM9	AMU9	JM5290	3	
3.1	1989.10	1989.10	103	140	LHO	6	-/6	AM16	AMU16	JM5290	3	VIN (T); OE 10467067
3.1	1991.01	1993.12	103	140	LHO	6	-/6	AM16	AMU16	JM5290	3	Exc. Methanol Conversion; OE 10467067
3.1	1991.01	1993.12	103	140	LHO	6	-/6	AM16	AMU16	X	3	w / Methanol Conversion; OE 1106008
3.1	1994.01	1994.09	103	140	LHO	6	-/6	AM16	AMU16	JM5290	3	VIN (T); OE 10467067
3.1	1994.10	1997.09	110	150	L82	6	1/6	AM9	AMU9	JM5290	3	
3.1	1994.10	1997.09	119	162	L82	6	1/6	AM9	AMU9	JM5290	3	
3.1	1999.10	2001.12	130	177	LG8	6	1/6	AM9	AMU9	JM5290	3	
3.4 Z34	1989.10	1994.09	149	203	LQ1	6		X	X	JM5290	3	
3.8	1991.10	1995.09	123	167	L27	6	-/6	AM8	AMU8	JM5290	3	
3.8	1992.12	1996.07	129	175	-	6	-/6	AM8	AMU8	JM5290	3	
<b>LUV KB 20</b>												
1.6	1972.01	1974.12	-	-	G161	4		X	X	JM5334	1	GT40RT
1.6	1974.01	1977.12	-	-	G161Z	4		X	X	JM5334	1	GT40RT
<b>MALIBU</b>												
2.2	2007.01	2008.12	107	145	-	4	-	-	-	JM5609	4	OE 12638824
2.2	2007.01	2008.12	108	147	L61	4	-	-	-	JM5609	4	OE 12638824
2.4	1996.08	1999.12	112	152	LD9	4		X	-	JM5384	2	JM1189; Coil Cover OE 10475706; VIN (T)
2.4	2007.09	2009.12	122	164	-	4	-	-	-	JM5609	4	OE 12638824
2.4	2007.09	2011.12	126	169	-	4	-	-	-	JM5609	4	OE 12638824
2.4	2012.01	-->	123	167	LE9	4	-	-	-	JM5609	4	OE 12638824
2.4	2012.01	-->	125	170	LE9	4	-	-	-	JM5609	4	OE 12638824
2.4	2012.01	-->	127	173	LE5	4	-	-	-	JM5609	4	OE 12638824
2.4	2012.01	-->	137	186	-	4	-	-	-	JM5609	4	OE 12638824
2.4 Hybrid	2012.01	-->	136	185	-	4	-	-	-	JM5609	4	OE 12638824
3.5	2003.10	2007.09	149	203	LX9	6		X	X	JM5496	1	
3.5	2005.10	2008.12	162	220	LZ4	6		X	X	JM5496	1	
<b>MATIZ</b>												
0.8	2005.03	-->	38	52	F8CV	3	-/3	AM47	AMU47	JM5218	1	
1.0	2005.03	-->	47	64	B10S	4	-/4	AM48	AMU48	JM5079	1	
1.0	2005.03	-->	49	67	B10S1	4	-/4	AM48	AMU48	JM5079	1	
<b>MERIVA</b>												
1.4 Flex	2008.09	-->	73	99	-	4		X	X	JM5618	1	5-PINS; OE 94702536
1.4 Flex	2007.07	2012.07	77	105	X 14 YEH	4		X	X	JM5618	1	5-PINS; OE 94702536
<b>MONTANA</b>												
1.4	2009.10	-->	68	92	-	4		X	X	JM5618	1	5-PINS; OE 94702536
<b>MONTE CARLO</b>												
3.1 V6	1994.09	1999.12	119	162	-	6	-/6	AM8	AMU8	X	-	
3.4 V6	1995.09	1997.12	160	218	-	6	-/6	AM20	AMU20	X	-	
<b>NUBIRA</b>												
1.4	2006.01	-->	70	95	F14D3	4	-/4	D7S	D7E	JM5220	1	
1.6	2005.03	-->	80	109	F16D3	4	-/4	AM46	AMU46	JM5220	1	
1.8	2005.03	2006.01	90	122	T18SED	4	-/4	AM45	AMU45	JM5079	1	
1.8	2005.03	-->	90	122	T18SED	4	-	-	-	JM5500	1	
1.8	2005.08	2006.01	89	121	F18D3	4	-/4	AM45	AMU45	X	-	
1.8	2005.08	-->	89	121	F18D3	4	-	-	-	JM5500	1	
<b>OPTRA</b>												
1.8	2005.03	-->	90	122	T18SED	4	-	-	-	JM5500	1	
2.0	2003.08	2007.12	97	132	-	4		X	X	JM5038	1	4-PINS; OE 96350585
2.0	2005.01	2007.12	88	120	-	4		X	X	JM5038	1	4-PINS; OE 96350585
2.0	2008.01	2008.12	97	132	-	4		X	X	JM5079	1	3-PINS; OE 96253555
2.0	2008.01	-->	88	120	-	4		X	X	JM5079	1	3-PINS; OE 96253555
<b>PRISMA</b>												
1.4 Flex	2009.03	2011.01	69	94	-	4		X	X	JM5618	1	5-PINS; OE 94702536



													<b>CHEVROLET</b>	
<b>PRIZM</b>														
1.8	1997.05	1999.12	92	125	7A-FE	4		X	X	JM5434	2	VIN (8) OE 90919-02224		
1.8	1997.05	1999.12	95	129	1ZZ-FE	4		X	X	JM5434	2	VIN (8) OE 90919-02224		
1.8	2000.01	2001.08	92	125	7A-FE	4	-	-	-	JM5018	4	VIN (8) OE 90919-02239		
1.8	2000.01	2001.08	95	129	1ZZ-FE	4	-	-	-	JM5018	4	VIN (8) OE 90919-02239		
<b>REZZO</b>														
1.6	2005.03	-->	77	105	A16DMS	4	-/4	AM44	AMU44	JM5079	1			
2.0	2005.03	-->	90	122	T20SED	4	-/4	AM45	AMU45	JM5079	1			
<b>S10</b>														
2.2	1994.10	1998.09	90	122	LN2	4	-/4	AM18	AMU18	JM5290	2			
2.2	1994.10	2005.05	84	114	L43	4		X	X	JM5290	2			
2.5 4WD	1985.09	1991.12	93	126	-	4	1/4	AM35	AMU35	X	-			
2.8 AWD	1985.10	1991.09	98	133	LL1	6	1/6	AM3	AMU3	X	-			
4.3 AWD	1987.10	1991.09	119	162	LB4	6	1/6	AM83	AMU83	X	-			
4.3 AWD	1994.10	1995.09	119	162	LB4	6	1/6	AM83	AMU83	X	-			
4.3 AWD	1995.10	1997.12	127	173	LF6	6		X	X	JM5385	1	VIN (X)		
4.3 AWD	1995.10	1997.12	127	173	LF6	6		X	X	JM5385	1	VIN (W)		
4.3	1996.01	2002.12	142	193	L35	6		X	X	JM5385	1	VIN (W)		
4.3	1996.01	1999.12	142	193	L35	6		X	X	JM5385	1	VIN (X)		
4.3 AWD	1996.01	1998.12	142	193	LB4	6		X	X	JM5385	1	VIN (X)		
4.3 AWD	1996.01	2002.08	142	193	LB4	6		X	X	JM5385	1	VIN (W)		
4.3	2003.01	2004.12	142	193	L35	6		X	X	JM5385	1	VIN (X)		
<b>SILVERADO</b>														
4.3 1500	1999.10	2006.12	147	200	LB4	6		X	X	JM5386	1			
4.3 1500	2007.01	2008.12	147	200	LB4	6		X	X	JM5496	1			
4.3 1500	2009.01	-->	147	200	LB4	6		X	X	JM5442	6			
4.8 4x4	2005.06	2007.12	202	275	LY2	8		X	X	JM5473	8	system Mitsubishi		
4.8 4x4	2005.06	2007.12	202	275	LY2	8		X	X	JM5442	8	system Delphi		
4.8 4x4	2008.01	-->	202	275	LY2	8		X	X	JM5406	8	system Mitsubishi		
4.8 4x4	2008.01	-->	202	275	LY2	8		X	X	JM5439	8	system Delphi		
5.3 4x4	1999.10	2006.12	201	273	LM7	8		X	X	JM5473	8	system Mitsubishi		
5.3 4x4	1999.10	2006.12	201	273	LM7	8		X	X	JM5442	8	system Delphi		
5.3 4x4	2007.01	-->	201	273	LM7	8		X	X	JM5406	8	system Mitsubishi		
5.3 4x4	2007.01	-->	201	273	LM7	8		X	X	JM5439	8	system Delphi		
6.0	1999.10	2007.12	224	305	LQ4	8		X	X	JM5473	8	system Mitsubishi		
6.0	1999.10	2007.12	224	305	LQ4	8		X	X	JM5442	8	system Delphi		
6.0	2007.01	-->	224	305	LQ4	8		X	X	JM5406	8	system Mitsubishi		
6.0	2007.01	-->	224	305	LQ4	8		X	X	JM5439	8	system Delphi		
8.1	2003.01	2007.12	253	344	L18	8		X	X	JM5473	8			
<b>SPARK</b>														
0.8	2005.05	-->	37	50	F8CV	3	-/3	AM47	AMU47	JM5218	1			
1.0 SX	2005.05	-->	46	63	-	4	-/4	AM48	AMU48	JM5079	1			
<b>SUBURBAN</b>														
5.3	2000.05	2006.06	209	284	L59, LM7	8		X	X	JM5473	8	system Mitsubishi		
5.3	2000.05	2006.06	209	284	L59, LM7	8		X	X	JM5442	8	system Delphi		
5.3 Hybrid	2001.09	2006.06	217	295	L59	8		X	X	JM5473	8	system Mitsubishi		
5.3 Hybrid	2001.09	2006.06	217	295	L59	8		X	X	JM5442	8	system Delphi		
5.7 Tailgate	1978.10	1984.09	123	167	LS9 (5.7L)	8		X	X	JM5367	1			
5.7	1991.10	1995.12	157	214	LO5	8		X	X	JM5369	1			
5.7	1996.01	1996.09	157	214	LO5	8		X	X	JM5385	1			
5.7 AWD	1996.09	1996.12	190	258	L31	8		X	X	JM5385	1			
5.7	1996.10	2000.04	190	258	L31	8	1/8	AM88	AMU88	JM5385	1			
6.0	2000.05	2003.09	235	320	LQ4	8		X	X	JM5473	8	system Mitsubishi		
6.0	2000.05	2003.09	235	320	LQ4	8		X	X	JM5442	8	system Delphi		
6.0	2002.10	2006.06	239	325	LY6	8		X	X	JM5473	8	system Mitsubishi		
6.0	2002.10	2006.06	239	325	LY6	8		X	X	JM5442	8	system Delphi		
6.0	2006.07	2008.12	263	358	LY6	8		X	X	JM5406	8	sys. Mitsubishi; VIN (Y)		
6.0	2006.07	2008.12	263	358	LY6	8		X	X	JM5439	8	sys. Delphi; VIN (Y)		
6.0 AWD	2006.07	2008.12	273	371	LY6	8		X	X	JM5406	8	sys. Mitsubishi; VIN (Y)		
6.0 AWD	2006.07	2008.12	273	371	LY6	8		X	X	JM5439	8	sys. Delphi; VIN (Y)		
7.4 AWD	1991.10	1995.09	170	231	-	8		X	X	JM5369	1			
8.1	2000.05	2006.06	254	345	L18	8		X	X	JM5473	8	system Mitsubishi		
8.1	2000.05	2006.06	254	345	L18	8		X	X	JM5442	8	system Delphi		



## CHEVROLET

TACUMA											
1.8	2000.05	2002.05	72	98	SOHC	4	-/4	AM77	AMU77	X	-
TAHOE											
4.8	1999.12	2006.12	206	280	LR4	8		X	X	JM5473	8 system Mitsubishi
4.8	1999.12	2006.12	206	280	LR4	8		X	X	JM5442	8 system Delphi
5.7 V8	1996.01	2000.12	190	258	LO5	8		X	X	JM5385	1 VIN (R)
5.3	2000.05	2002.09	201	273	LR4	8		X	X	JM5473	8 system Mitsubishi
5.3	2000.05	2002.09	201	273	LR4	8		X	X	JM5442	8 system Delphi
5.3	2002.10	2006.12	213	290	L59	8		X	X	JM5473	8 system Mitsubishi
5.3	2002.10	2006.12	213	290	L59	8		X	X	JM5442	8 system Delphi
5.3	2003.09	2006.12	220	299	LM7	8		X	X	JM5473	8 system Mitsubishi
5.3	2003.09	2006.12	220	299	LM7	8		X	X	JM5442	8 system Delphi
5.3 4x4	2007.01	2008.12	239	325	LY5	8		X	X	JM5406	8 system Mitsubishi
5.3 4x4	2007.01	2008.12	239	325	LY5	8		X	X	JM5439	8 system Delphi
TRACKER											
1.6	1999.01	2000.12	71	97	G16B	4		X	X	JM5472	2 VIN (6) OE 33410-66D10
TRAILBLAZER											
4.2 AWD	2005.08	2009.12	217	295	-	6	-	-	-	JM5405	6 VIN (S)
4.2 AWD	2006.01	2009.12	201	273	LL8	6	-	-	-	JM5405	6 VIN (S)
5.3 AWD	2002.08	2004.12	213	290	L59	4		X	X	JM5473	8 sys. Mitsubishi; VIN (P)
5.3 AWD	2002.08	2004.12	213	290	L59	4		X	X	JM5442	8 sys. Delphi; VIN (P)
5.3 AWD	2005.01	2008.12	213	290	L59	4		X	X	JM5406	8 sys. Mitsubishi; VIN (M)
5.3 AWD	2005.01	2008.12	213	290	L59	4		X	X	JM5439	8 sys. Delphi; VIN (M)
6.0 AWD	2005.09	2008.09	295	401	LS2	8		X	X	JM5473	8 sys. Mitsubishi; VIN (H)
6.0 AWD	2005.09	2008.09	295	401	LS2	8		X	X	JM5442	8 sys. Delphi; VIN (H)
UPLANDER											
3.5 LS	2004.04	2006.12	149	203	LX9	6		X	X	JM5496	1 VIN (L)
3.9 LT	2004.08	2009.12	179	243	LZ9	6		X	X	JM5496	1 VIN (1), VIN (W)
VECTRA											
2.2	2004.05	2006.07	114	155	Z 22 YH	4	-	-	-	ODM262	1 OE 9153250
2.2	2005.07	-->	110	150	Z 22 YH	4	-	-	-	ODM262	1 OE 9153250
2.8	2005.11	2006.09	188	256	Z 28 NET	6	-	-	-	JM5426	6 OE 12613057
2.8	2006.10	-->	184	250	Z 28 NET	6	-	-	-	JM5426	6 OE 12613057

## CHEVROLET USA

ASTRO											
2.5	1985.01	1990.12	69	94	-	4		X	X	JM5369	1 VIN (E)
2.5	1990.01	1990.12	72	98	-	4		X	X	JM5369	1 VIN (E)
4.3	1985.01	1985.12	112	152	-	6		X	X	JM5367	1 VIN (N)
4.3	1990.01	1998.12	112	152	-	6		X	X	JM5369	1 VIN (B), VIN (W), VIN (Z)
4.3	1996.01	2001.12	112	152	-	6		X	X	JM5385	1 VIN (W)
4.3	2002.01	2005.12	112	152	-	6		X	X	JM5385	1 VIN (X)
AVALANCHE											
5.3	2001.09	2004.12	219	298	-	8		X	X	JM5473	8 sys. Mitsubishi; VIN (T)
5.3	2001.09	2004.12	219	298	-	8		X	X	JM5442	8 system Delphi; VIN (T)
5.3 Flexfuel	2004.09	2006.12	219	298	-	8		X	X	JM5473	8 sys. Mitsubishi; VIN (Z)
5.3 Flexfuel	2004.09	2006.12	219	298	-	8		X	X	JM5442	8 system Delphi; VIN (Z)
5.3 Flexfuel	2006.09	2009.12	231	314	-	8		X	X	JM5406	8 system Mitsubishi VIN (0), VIN (3), VIN (J)
5.3 Flexfuel	2006.09	2009.12	231	314	-	8		X	X	JM5439	8 system Delphi VIN (0), VIN (3), VIN (J)
5.3 Flexfuel	2006.09	2011.12	239	320	-	8		X	X	JM5406	8 system Mitsubishi VIN (0), VIN (3), VIN (J)
5.3 Flexfuel	2006.09	2011.12	239	320	-	8		X	X	JM5439	8 system Delphi VIN (0), VIN (3), VIN (J)
6.0	2007.09	2008.12	273	366	-	8		X	X	JM5406	8 sys. Mitsubishi; VIN (Y)
6.0	2007.09	2008.12	273	366	-	8		X	X	JM5439	8 system Delphi; VIN (Y)
8.1 4WD	2003.09	2006.12	257	350	-	8		X	X	JM5473	8 VIN (G)
AVEO											
1.6	2003.09	2008.12	77	105	-	4		X	X	JM5079	1
BEL AIR											
5.4	1967.09	1969.12	157	214	-	8	1/8	AM97	AMU97	X	-
5.7	1968.09	1969.12	108	147	-	8	1/8	AM97	AMU97	X	-
6.6	1969.09	1974.12	112	152	-	8	1/8	AM97	AMU97	X	-
BERETTA											
2.3 DOHC	1989.09	1994.12	131	178	-	4		X	-	JM5384	2 JM1189; Coil Cover
2.3 DOHC	1989.09	1990.12	134	182	-	4		X	-	JM5384	2 OE 10475706; VIN (A)

**CHEVROLET USA**

BISCAINE											
5.4	1967.09	1969.12	157	214	-	8	1/8	AM97	AMU97	X	-
6.6	1969.09	1972.12	227	309	-	8	1/8	AM97	AMU97	X	-
BLAZER											
4.3	1996.01	2001.12	149	203	-	6		X	X	JM5385	1 VIN (W)
4.3	2002.09	2005.12	142	193	-	6		X	X	JM5385	1 VIN (X)
C10											
4.1	1975.01	1977.12	75	102	-	6		X	X	JM5368	1 VIN (Q), VIN (D)
4.1	1975.01	1977.12	78	106	-	6		X	X	JM5368	1 VIN (Q), VIN (D)
4.1	1980.01	1980.12	75	102	-	6		X	X	JM5366	1 VIN (D); Exc. California
4.1	1980.01	1980.12	75	102	-	6		X	X	JM5367	1 VIN (D); California
4.1	1980.01	1980.12	78	106	-	6		X	X	JM5366	1 VIN (D); Exc. California
4.1	1980.01	1980.12	78	106	-	6		X	X	JM5367	1 VIN (D); California
4.8	1975.01	1977.12	90	122	-	6		X	X	JM5368	1 VIN (T)
4.8	1979.01	1980.12	90	122	-	6		X	X	JM5366	1 VIN (T)
C35											
5.7	1996.01	2000.12	190	255	-	8		X	X	JM5385	1
C1500											
4.3	1996.01	1998.12	119	162	-	6		X	X	JM5385	1 VIN (W)
5.0	1996.01	1999.12	131	178	-	8		X	X	JM5385	1 VIN (M)
5.7	1996.01	1999.12	160	218	-	8		X	X	JM5385	1 VIN (R)
C2500											
5.0	1996.01	1998.12	131	178	-	8		X	X	JM5385	1 VIN (M)
5.0	1996.01	1998.12	276	375	-	8		X	X	JM5385	1 VIN (M)
5.7	1996.01	2000.12	160	218	-	8		X	X	JM5385	1 VIN (R)
5.7	1996.01	2000.12	187	254	-	8		X	X	JM5385	1 VIN (R)
5.7	1998.09	2000.12	190	258	-	8		X	X	JM5385	1 VIN (R)
7.4	1996.01	2000.12	276	375	-	8		X	X	JM5385	1 VIN (J)
C3500											
5.7	1996.01	2000.12	160	218	-	8		X	X	JM5385	1 VIN (R)
7.4	1996.01	2000.12	175	238	-	8		X	X	JM5385	1 VIN (J)
7.4	1996.01	2000.12	216	294	-	8		X	X	JM5385	1 VIN (J)
C4500											
8.1 V8 496cid	2003.01	2009.12	-	-	-	8		X	X	JM5473	8
C5500											
8.1 V8 496cid	2003.01	2009.12	-	-	-	8		X	X	JM5473	8
C6500											
8.1 V8 496cid	2001.01	2009.12	-	-	-	8		X	X	JM5473	8
C7500											
8.1 V8 496cid	2001.01	2009.12	-	-	-	8		X	X	JM5473	8
CAMARO											
5.0	1967.09	1969.12	99	135	-	8	1/8	AM97	AMU97	X	-
5.4	1967.09	1969.12	159	216	-	8	1/8	AM97	AMU97	X	-
5.7	1967.09	1969.12	108	147	-	8	1/8	AM97	AMU97	X	-
5.7	1974.09	1979.12	108	147	-	8	1/8	AM97	AMU97	X	-
5.7	1992.09	1994.12	205	279	-	8	1/8	AM36	AMU36	JM5369	1
6.2 SS	2009.09	2011.12	299	400	-	8		X	X	JM5406	8 sys. Mitsubishi; 376cid
6.2 SS	2009.09	2011.12	299	400	-	8		X	X	JM5439	8 sys. Delphi; 376cid
6.2 SS	2009.09	-->	314	426	-	8		X	X	JM5406	8 sys. Mitsubishi; 376cid
6.2 SS	2009.09	-->	314	426	-	8		X	X	JM5439	8 sys. Delphi; 376cid
6.2	2011.09	-->	433	580	-	8		X	X	JM5406	8 system Mitsubishi
6.2	2011.09	-->	433	580	-	8		X	X	JM5439	8 system Delphi
6.6	1969.09	1972.12	181	246	-	8	1/8	AM97	AMU97	X	-
CAPRICE											
4.3	1996.01	1996.12	151	205	-	8		X	X	JM5385	1 VIN (W)
5.7	1996.01	1996.12	78	105	-	8		X	X	JM5385	1 VIN (P)
6.0 PPV Flexfuel	2010.09	-->	264	355	-	8		X	X	JM5406	8 system Mitsubishi
CAPTIVA SPORT											
2.4 FLEX	2011.09	-->	136	182	-	4	-	-	-	JM5609	4 OE 12638824
2.4 FLEX	2012.01	-->	136	182	-	4	-	-	-	JM5609	4 OE 12638824
CARGOVAN											
5.7 V8 350cid	1996.09	1999.12	-	-	-	8		X	X	JM5385	1 Mexico
CAVALIER											
2.3	1994.09	1995.12	112	152	-	4		X	-	JM5384	2 JM1189; Coil Cover OE 10475706 VIN (D); Mexico
2.4 DOHC	1994.09	1995.12	112	152	-	4		X	-	JM5384	2 JM1189; Coil Cover OE 10475706; VIN (T)



<b>CHEVROLET USA</b>												
<b>CELEBRITY</b>												
2.8	1987.01	1988.12	68	92	-	6	-/6	AM16	AMU16	JM5290	3	VIN (W); OE 10467067
2.8	1987.01	1988.12	83	113	-	6	-/6	AM16	AMU16	JM5290	3	VIN (W); OE 10467067
2.8	1987.01	1989.12	97	132	-	6	-/6	AM16	AMU16	JM5290	3	VIN (W); OE 10467067
3.1	1989.09	1990.12	104	140	-	6	-/6	AM16	AMU16	JM5290	3	VIN (T); OE 10467067
<b>CHEVY</b>												
1.6	1997.09	2006.12	75	102	-	4		X	X	JM5038	1	Mexico
1.6	1998.09	2003.12	68	91	-	4		X	X	JM5038	1	Mexico
<b>CHEYENNE</b>												
5.3	2006.09	2008.12	235	315	-	8		X	X	JM5406	8	system Mitsubishi
5.3	2006.09	2008.12	235	315	-	8		X	X	JM5439	8	system Delphi
<b>CIRRUS</b>												
2.4	2007.09	2010.12	113	152	-	4		X	X	JM5404	4	VIN (4)
<b>COBALT</b>												
2.0	2005.09	2006.12	153	208	-	4	-	-	-	JM5478	4	VIN (P)
2.0 SS	2007.09	2008.12	116	158	-	4	-	-	-	JM5609	4	OE 12638824
2.0 SS	2007.09	2008.12	116	158	-	4	-	-	-	JM5478	4	
2.0 SS	2008.09	2010.12	194	264	-	4	-	-	-	JM5609	4	OE 12638824
2.2	2007.01	2008.12	108	147	-	4	-	-	-	JM5609	4	OE 12638824
2.2	2008.09	2010.12	116	158	-	4	-	-	-	JM5609	4	OE 12638824
2.4	2005.09	2006.12	128	174	-	4	-	-	-	JM5609	4	OE 12638824
2.4	2007.09	2008.12	128	174	-	4	-	-	-	JM5609	4	OE 12638824
<b>COLORADO</b>												
2.9	2006.09	2012.12	138	188	-	4	-	-	-	JM5405	4	VIN (9)
3.7	2007.09	2012.12	181	246	-	5	-	-	-	JM5405	5	VIN (E)
5.3	2008.09	2011.12	224	300	-	8		X	X	JM5406	8	system Mitsubishi VIN (L), VIN (P)
5.3	2008.09	2011.12	224	300	-	8		X	X	JM5439	8	system Delphi VIN (L), VIN (P)
5.3	2011.09	-->	224	300	-	8		X	X	JM5406	8	system Mitsubishi
5.3	2011.09	-->	224	300	-	8		X	X	JM5439	8	system Delphi
<b>CORVETTE</b>												
5.7	1974.09	1982.12	123	167	-	8	-/8	AM100	AMU100	X	-	
5.7	1974.09	1982.12	151	205	-	8	-/8	AM100	AMU100	X	-	
5.7	1996.01	1996.12	123	167	-	8		X	X	JM5385	1	VIN (P)
5.7	1996.01	1996.12	123	167	-	8		X	X	JM5385	1	VIN (5); 6 MTM
5.7	1996.01	1996.12	224	305	-	8		X	X	JM5385	1	VIN (P)
5.7	1996.01	1996.12	224	305	-	8		X	X	JM5385	1	VIN (5); 6 MTM
6.0	2004.09	2005.12	302	411	-	8		X	X	JM5406	1	system Mitsubishi
6.0	2004.09	2005.12	302	411	-	8		X	X	JM5439	1	system Delphi
6.2	2007.09	2011.12	321	430	-	8		X	X	JM5406	8	sys. Mitsubishi; VIN (W)
6.2	2007.09	2011.12	321	430	-	8		X	X	JM5439	8	sys. Delphi; VIN (W)
6.2	2011.09	-->	476	638	-	8		X	X	JM5406	8	sys. Mitsubishi; VIN (T)
6.2	2011.09	-->	476	638	-	8		X	X	JM5439	8	sys. Delphi; VIN (T)
7.0 Z06	2005.09	2007.12	377	513	-	8		X	X	JM5406	1	sys. Mitsubishi; VIN (E)
7.0 Z06	2005.09	2007.12	377	513	-	8		X	X	JM5439	1	sys. Delphi; VIN (E)
7.0	2007.09	2009.12	377	513	-	8		X	X	JM5406	8	sys. Mitsubishi; VIN (E)
7.0	2007.09	2009.12	377	513	-	8		X	X	JM5439	8	sys. Delphi; VIN (E)
<b>EQUINOX</b>												
2.4	2009.09	2010.12	136	182	-	4	-	-	-	JM5609	4	OE 12638824
2.4 FLEX	2012.09	-->	136	182	-	4	-	-	-	JM5609	4	OE 12638824
3.4 AWD	2004.09	2007.12	138	188	-	6		X	X	JM5496	1	
3.4 AWD	2007.09	2009.12	138	185	-	6		X	X	JM5496	1	
<b>EXPRESS</b>												
4.3 Flexfuel	2012.01	-->	145	197	LU3	6		X	X	JM5496	1	
<b>EXPRESS 1500</b>												
4.3	1995.09	2006.12	149	203	-	6		X	X	JM5385	1	VIN (W), VIN (X)
4.3 AWD	2002.09	2006.12	149	203	-	6		X	X	JM5385	1	VIN (W), VIN (X)
5.0	1995.09	2002.12	164	223	-	8		X	X	JM5385	1	VIN (M)
5.3 AWD	2006.09	2007.12	220	295	-	8		X	X	JM5442	8	VIN (T)
5.3 Flexfuel	2007.09	2010.12	225	301	-	8		X	X	JM5406	8	sys. Mitsubishi; VIN (4)
5.3 Flexfuel	2007.09	2010.12	225	301	-	8		X	X	JM5439	8	sys. Delphi; VIN (4)
5.3 Flexfuel	2007.09	2010.12	231	310	-	8		X	X	JM5406	8	sys. Mitsubishi; VIN (4)
5.3 Flexfuel	2007.09	2010.12	231	310	-	8		X	X	JM5439	8	sys. Delphi; VIN (4)
5.3	2009.12	2011.12	220	295	-	8		X	X	JM5406	8	sys. Mitsubishi; VIN (4)
5.3	2009.12	2011.12	220	295	-	8		X	X	JM5439	8	sys. Delphi; VIN (4)
5.3 FLEX AWD	2010.09	-->	231	310	-	8		X	X	JM5406	8	system Mitsubishi
5.3 FLEX AWD	2010.09	-->	231	310	-	8		X	X	JM5439	8	system Delphi



CHEVROLET USA											
<b>EXPRESS 1500</b>											
5.7	1995.09	2002.12	190	258	-	8	X	X	JM5385	1	VIN (R)
<b>EXPRESS 2500</b>											
4.3	1995.09	2005.12	149	203	-	6	X	X	JM5385	1	VIN (W), VIN (X)
4.8	2009.01	2009.12	208	283	-	8	X	X	JM5406	8	sys. Mitsubishi; VIN (C)
4.8	2009.01	2009.12	208	283	-	8	X	X	JM5439	8	sys. Delphi; VIN (C)
4.8 Flexfuel	2009.09	2010.12	208	283	-	8	X	X	JM5406	8	sys. Mitsubishi; VIN (A)
4.8 Flexfuel	2009.09	2010.12	208	283	-	8	X	X	JM5439	8	sys. Delphi; VIN (A)
5.0	1995.09	1996.12	164	223	-	8	X	X	JM5385	1	VIN (H), VIN (M)
5.0	1995.09	2002.12	190	258	-	8	X	X	JM5385	1	VIN (H), VIN (M)
5.7	1995.09	2002.12	190	258	-	8	X	X	JM5385	1	VIN (R)
6.0	2007.09	2009.12	208	283	-	8	X	X	JM5406	8	system Mitsubishi VIN (K), VIN (G)
6.0	2007.09	2009.12	208	283	-	8	X	X	JM5439	8	system Delphi VIN (K), VIN (G)
6.0	2007.09	2010.12	241	328	-	8	X	X	JM5406	8	sys. Mitsubishi; VIN (G)
6.0	2007.09	2010.12	241	328	-	8	X	X	JM5439	8	sys. Delphi; VIN (G)
<b>EXPRESS 3500</b>											
4.8	2007.09	2008.12	208	279	-	8	X	X	JM5406	8	sys. Mitsubishi; VIN (C)
4.8	2007.09	2008.12	208	279	-	8	X	X	JM5439	8	sys. Delphi; VIN (C)
4.8 Flexfuel	2009.09	2011.12	208	279	-	8	X	X	JM5406	8	sys. Mitsubishi; VIN (A)
4.8 Flexfuel	2009.09	2011.12	208	279	-	8	X	X	JM5439	8	sys. Delphi; VIN (A)
5.3	2007.09	2008.12	231	314	-	8	X	X	JM5406	8	system Mitsubishi
5.3	2007.09	2008.12	231	314	-	8	X	X	JM5439	8	system Delphi
5.7	1997.01	2002.12	190	258	-	8	X	X	JM5385	1	VIN (R)
6.0	2007.09	2009.12	241	328	-	8	X	X	JM5406	8	system Mitsubishi VIN (K), VIN (G)
6.0	2007.09	2009.12	241	328	-	8	X	X	JM5439	8	system Delphi VIN (K), VIN (G)
6.0 Flexfuel	2009.09	2011.12	241	328	-	8	X	X	JM5406	8	sys. Mitsubishi; VIN (G)
6.0 Flexfuel	2009.09	2011.12	241	328	-	8	X	X	JM5439	8	sys. Delphi; VIN (G)
6.0 FLEX	2011.09	-->	224	305	-	8	X	X	JM5406	8	system Mitsubishi
6.0 FLEX	2011.09	-->	224	305	-	8	X	X	JM5439	8	system Delphi
7.4	1995.09	2000.12	216	294	-	8	X	X	JM5385	1	VIN (J)
8.1	2000.09	2002.12	254	345	-	8	X	X	JM5473	8	VIN (G)
<b>EXPRESS 4500</b>											
6.0	2008.09	2009.09	224	300	-	8	X	X	JM5406	8	system Mitsubishi
6.0	2008.09	2009.09	224	300	-	8	X	X	JM5439	8	system Delphi
6.0 FLEX	2009.09	2012.12	224	300	-	8	X	X	JM5406	8	system Mitsubishi
6.0 FLEX	2009.09	2012.12	224	300	-	8	X	X	JM5439	8	system Delphi
6.0 FLEX	2011.09	-->	241	328	-	8	X	X	JM5406	8	system Mitsubishi
6.0 FLEX	2011.09	-->	241	328	-	8	X	X	JM5439	8	system Delphi
<b>G30</b>											
4.3	2000.09	2001.12	149	200	-	6	X	X	JM5385	1	
<b>GRAND VOYAGER</b>											
3.8	2000.09	2000.12	121	162	-	6	X	X	JM5388	1	
<b>HHR</b>											
2.0	2007.09	2009.12	187	253	-	4	-	-	JM5609	4	OE 12638824
2.0	2008.09	2010.12	194	264	-	4	-	-	JM5609	4	OE 12638824
2.2	2007.09	2008.12	111	151	-	4	-	-	JM5609	4	OE 12638824
2.2	2007.09	2008.12	116	158	-	4	-	-	JM5609	4	OE 12638824
2.2 Flexfuel	2008.09	2011.12	116	158	-	4	-	-	JM5609	4	OE 12638824
2.4	2007.01	2007.12	130	177	-	4	-	-	JM5609	4	OE 12638824
2.4	2007.09	2008.12	128	174	-	4	-	-	JM5609	4	OE 12638824
2.4 Flexfuel	2008.09	2011.12	128	174	-	4	-	-	JM5609	4	OE 12638824
<b>IMPALA</b>											
3.5 Flexfuel	2005.09	2007.12	157	214	-	6	X	X	JM5496	1	VIN (K), VIN (N)
3.5	2007.09	2009.12	157	214	-	6	X	X	JM5496	1	VIN (K), VIN (N)
3.5 Flexfuel	2007.09	2011.12	154	209	-	6	X	X	JM5496	1	VIN (K), VIN (N)
3.9	2005.09	2007.12	157	214	-	6	X	X	JM5496	1	VIN (1), VIN (R)
3.9 Flexfuel	2008.09	2009.12	167	224	-	6	X	X	JM5496	1	VIN (3), VIN (M)
3.9 Flexfuel	2009.09	2011.12	172	230	-	6	X	X	JM5496	1	VIN (M)
5.3 SS	2005.09	2007.12	226	307	-	8	X	X	JM5406	8	sys. Mitsubishi; VIN (C)
5.3 SS	2005.09	2007.12	226	307	-	8	X	X	JM5439	8	sys. Delphi; VIN (C)
5.3	2008.01	2009.12	-	-	-	8	X	X	JM5406	8	sys. Mitsubishi; VIN (C)
5.3	2008.01	2009.12	-	-	-	8	X	X	JM5439	8	sys. Delphi; VIN (C)
5.7	1993.09	1996.12	108	145	-	8	X	X	JM5385	1	od 01.1996; VIN (P)
5.7	1993.09	1996.12	193	258	-	8	X	X	JM5385	1	od 01.1996; VIN (P)



<b>CHEVROLET USA</b>											
<b>K1500</b>											
4.3 4WD	1996.01	1998.12	119	162	-	6		X	X	JM5385	1 VIN (W)
4.3 4WD	1996.01	1998.12	149	203	-	6		X	X	JM5385	1 VIN (W)
5.0 4WD	1996.01	1999.12	131	178	-	8		X	X	JM5385	1 VIN (M)
5.7 4WD	1996.01	1999.12	149	203	-	8		X	X	JM5385	1 VIN (R)
5.7 4WD	1996.01	1999.12	160	218	-	8		X	X	JM5385	1 VIN (R)
<b>K2500</b>											
5.0 4WD	1997.01	1998.12	131	178	-	8		X	X	JM5385	1 VIN (M)
5.7 4WD	1996.01	2000.12	149	203	-	8		X	X	JM5385	1 VIN (R)
5.7 4WD	1998.09	2000.12	190	258	-	8		X	X	JM5385	1 VIN (R)
7.4 4WD	1996.01	2000.12	172	234	-	8		X	X	JM5385	1 VIN (J)
7.4 4WD	1998.09	2000.12	216	294	-	8		X	X	JM5385	1 VIN (J)
<b>K3500</b>											
5.7 4WD	1991.09	2000.12	149	203	-	8		X	X	JM5385	1 VIN (R)
7.4 4WD	1991.09	2000.12	172	234	-	8		X	X	JM5385	1 VIN (J)
<b>KODIAK</b>											
8.1 V8	2003.01	2008.12	-	-	-	8		X	X	JM5473	8
<b>LUMINA APV</b>											
3.1	1989.08	1996.07	90	122	-	6	1/6	AM9	AMU9	JM5290	3 VIN (T), VIN (M)
<b>LUMINA</b>											
3.1	1993.09	1994.12	104	141	-	6	-/6	AM16	AMU16	JM5290	3 VIN (T); OE 10467067
3.1	1994.09	2001.12	104	141	-	6		X	X	JM5290	3 VIN (M), VIN (J)
3.1 Flexfuel	1992.09	1994.12	104	141	-	6	-/6	AM16	AMU16	JM5290	3 Exc. Methanol Conversion; VIN (T) OE 10467067
3.1 Flexfuel	1992.09	1994.12	104	141	-	6	-/6	AM16	AMU16	X	3 w / Methanol Conversion; VIN (T) OE 1106008
<b>LUV</b>											
1.8	1971.09	1975.12	56	76	-	4		X	X	JM5355	1 VIN (N)
<b>MALIBU</b>											
2.4	1996.08	1999.09	112	152	-	4		X	-	JM5384	2 JM1189; Coil Cover OE 10475706; VIN (T)
3.5	2006.09	2007.12	157	214	-	6		X	X	JM5496	1 VIN (8)
3.5	2007.09	2008.12	157	214	-	6		X	X	JM5496	1 VIN (N)
3.5 Flexfuel	2009.09	2010.12	154	209	-	6		X	X	JM5496	1 VIN (N), VIN (K)
3.9	2005.09	2007.12	179	243	-	6		X	X	JM5496	1 VIN (1)
<b>METRO</b>											
1.3	1999.01	2000.12	59	80	-	4		X	X	JM5472	2 VIN (2) OE 33410-66D10
<b>MONTE CARLO</b>											
3.5 Flexfuel	2005.09	2007.12	157	214	-	6		X	X	JM5496	1 VIN (K), VIN (N)
3.9	2005.09	2006.12	181	246	-	6		X	X	JM5496	1 VIN (1)
5.3 SS	2005.09	2007.12	226	307	-	8		X	X	JM5406	8 sys. Mitsubishi; VIN (C)
5.3 SS	2005.09	2007.12	226	307	-	8		X	X	JM5439	8 sys. Delphi; VIN (C)
<b>NOVA</b>											
1.6	1985.01	1988.12	55	75	-	4		X	X	JM5180	1
<b>OPTRA</b>											
2.0	2003.09	2004.12	89	121	-	4		X	X	JM5038	1
2.0	2004.09	2005.12	94	128	-	4		X	X	JM5038	1 VIN (Z); OE 96350585
2.0	2005.09	2006.12	94	128	-	4		X	X	JM5038	1 VIN (Z)
<b>ORLANDO</b>											
2.4 L4	2011.09	-->	130	177	-	4	-	-	-	JM5609	4 VIN (M); OE 12638824
<b>P30</b>											
4.1 V6	2001.01	2001.12	-	-	-	6		X	X	JM5385	1 Mexico
4.3	1996.01	1995.12	116	158	-	6		X	X	JM5385	1 VIN (W)
4.3 V6	2001.01	2001.12	-	-	-	6		X	X	JM5385	1 Mexico
5.7	1996.01	1996.12	108	147	-	8		X	X	JM5219	1 VIN (K); USA
5.7	1996.01	1999.12	108	147	-	8		X	X	JM5385	1 VIN (R); USA
5.7	1996.01	1996.12	149	203	-	8		X	X	JM5219	1 VIN (K); USA
5.7	1996.01	1999.12	149	203	-	8		X	X	JM5385	1 VIN (R); USA
7.4	1988.01	1999.12	153	208	-	8		X	X	X	8 VIN (B); MFI
7.4	1996.01	1999.12	153	208	-	8		X	X	JM5385	1 VIN (J); SFI
7.4	1996.01	1997.12	153	208	-	8		X	X	JM5219	1 VIN (N); TBI
7.4	1996.01	1999.12	172	234	-	8		X	X	JM5385	1 VIN (J); SFI
7.4	1996.01	1997.12	172	234	-	8		X	X	JM5219	1 VIN (N); TBI
7.4	1998.01	1999.12	172	234	-	8		X	X	X	8 VIN (B); MFI



**CHEVROLET USA**

PRIZM												
1.8	1997.09	1999.12	90	122	-	4			X	X	JM5434	2 VIN (8) OE 90919-02224
1.8	2000.01	2002.12	90	122	-	4	-	-	-	-	JM5018	4 VIN (8) OE 90919-02239
S10												
4.3	1996.01	2003.12	147	200	-	6			X	X	JM5385	1 VIN (X), VIN (W)
4.3	2000.09	2003.12	148	201	-	6			X	X	JM5385	1 VIN (X), VIN (W)
SILVERADO 1500												
4.3	2003.09	2005.12	145	197	-	6			X	X	JM5385	1 VIN (X)
4.3	2007.09	2008.12	145	197	-	6			X	X	JM5496	1
4.3	2012.01	-->	145	197	-	6			X	X	JM5385	1
4.8	1998.09	2005.12	190	258	-	8			X	X	JM5473	8 sys. Mitsubishi; VIN (V)
4.8	1998.09	2005.12	190	258	-	8			X	X	JM5442	8 sys. Delphi; VIN (V)
4.8	1998.09	2005.12	213	290	-	8			X	X	JM5473	8 sys. Mitsubishi; VIN (V)
4.8	1998.09	2005.12	213	290	-	8			X	X	JM5442	8 sys. Delphi; VIN (V)
4.8	2007.09	2007.12	220	295	-	8			X	X	JM5473	8 sys. Mitsubishi; VIN (V)
4.8	2007.09	2007.12	220	295	-	8			X	X	JM5442	8 sys. Delphi; VIN (V)
4.8	2007.09	2008.12	220	295	-	8			X	X	JM5406	8 sys. Mitsubishi; VIN (C)
4.8	2007.09	2008.12	220	295	-	8			X	X	JM5439	8 sys. Delphi; VIN (C)
4.8 Flexfuel	2009.09	2010.12	220	295	-	8			X	X	JM5406	8 sys. Mitsubishi; VIN (A)
4.8 Flexfuel	2009.09	2010.12	220	295	-	8			X	X	JM5439	8 sys. Delphi; VIN (A)
4.8 Flexfuel	2009.09	2010.12	225	302	-	8			X	X	JM5406	8 sys. Mitsubishi; VIN (A)
4.8 Flexfuel	2009.09	2010.12	225	302	-	8			X	X	JM5439	8 sys. Delphi; VIN (A)
4.8 FLEX	2010.09	-->	225	302	-	8			X	X	JM5406	8 sys. Mitsubishi; VIN (A)
4.8 FLEX	2010.09	-->	225	302	-	8			X	X	JM5439	8 sys. Delphi; VIN (A)
5.3 Flexfuel	2001.09	2005.12	213	290	-	8			X	X	JM5473	8 sys. Mitsubishi; VIN (T), VIN (Z)
5.3 Flexfuel	2001.09	2005.12	213	290	-	8			X	X	JM5442	8 system Delphi VIN (T), VIN (Z)
5.3	2003.09	2005.12	220	299	-	8			X	X	JM5473	8 system Mitsubishi VIN (T), VIN (Z)
5.3	2003.09	2005.12	220	299	-	8			X	X	JM5442	8 system Delphi VIN (T), VIN (Z)
5.3 Flexfuel	2003.09	2007.12	223	303	-	8			X	X	JM5473	8 system Mitsubishi VIN (T), VIN (Z)
5.3 Flexfuel	2003.09	2007.12	223	303	-	8			X	X	JM5442	8 system Delphi VIN (T), VIN (Z)
5.3 Flexfuel	2007.01	2009.12	235	320	-	8			X	X	JM5406	8 system Mitsubishi VIN (0), VIN (3), VIN (J)
5.3 Flexfuel	2007.01	2009.12	235	320	-	8			X	X	JM5439	8 system Delphi VIN (0), VIN (3), VIN (J)
5.3 Flexfuel	2007.09	2007.12	235	320	-	8			X	X	JM5473	8 sys. Mitsubishi; VIN (Z)
5.3 Flexfuel	2007.09	2007.12	235	320	-	8			X	X	JM5442	8 sys. Delphi; VIN (Z)
5.3 FLEX	2010.09	2012.12	243	330	-	8			X	X	JM5406	8 system Mitsubishi VIN (0), VIN (3)
5.3 FLEX	2010.09	2012.12	243	330	-	8			X	X	JM5439	8 system Delphi VIN (0), VIN (3)
6.0	2000.09	2007.12	228	310	-	8			X	X	JM5473	8 sys. Mitsubishi; VIN (U)
6.0	2000.09	2007.12	228	310	-	8			X	X	JM5442	8 system Delphi; VIN (U)
6.0 AWD	2002.09	2005.12	254	345	-	8			X	X	JM5473	8 sys. Mitsubishi; VIN (N)
6.0 AWD	2002.09	2005.12	254	345	-	8			X	X	JM5442	8 system Delphi; VIN (N)
6.0	2005.09	2006.12	257	350	-	8			X	X	JM5473	8 sys. Mitsubishi; VIN (N)
6.0	2005.09	2006.12	257	350	-	8			X	X	JM5442	8 system Delphi; VIN (N)
6.0	2007.09	2007.12	274	373	-	8			X	X	JM5473	8 sys. Mitsubishi; VIN (N)
6.0	2007.09	2007.12	274	373	-	8			X	X	JM5442	8 system Delphi; VIN (N)
6.0	2007.09	2007.12	274	373	-	8			X	X	JM5406	8 sys. Mitsubishi; VIN (Y)
6.0	2007.09	2007.12	274	373	-	8			X	X	JM5439	8 sys. Delphi; VIN (Y)
6.0	2008.09	-->	248	337	-	8			X	X	JM5406	8 system Mitsubishi VIN (Y), VIN (J)
6.0	2008.09	-->	248	337	-	8			X	X	JM5439	8 system Delphi VIN (Y), VIN (J)
6.2 Flexfuel	2008.09	2010.12	301	403	-	8			X	X	JM5406	8 sys. Mitsubishi; VIN (2)
6.2 Flexfuel	2008.09	2010.12	301	403	-	8			X	X	JM5439	8 system Delphi; VIN (2)
6.2 FLEX	2010.09	-->	301	409	-	8			X	X	JM5406	8 sys. Mitsubishi; VIN (2)
6.2 FLEX	2010.09	-->	301	409	-	8			X	X	JM5439	8 system Delphi; VIN (2)
SILVERADO 2500												
5.3	1998.09	2000.12	213	290	-	8			X	X	JM5473	8 sys. Mitsubishi; VIN (T)
5.3	1998.09	2000.12	213	290	-	8			X	X	JM5442	8 system Delphi; VIN (T)
5.3 4WD	1998.09	2000.12	204	277	-	8			X	X	JM5473	8 sys. Mitsubishi; VIN (T)
5.3 4WD	1998.09	2000.12	204	277	-	8			X	X	JM5442	8 system Delphi; VIN (T)
5.3	2005.09	2006.12	220	299	-	8			X	X	JM5473	8 system Mitsubishi



<b>CHEVROLET USA</b>												
<b>SILVERADO 2500</b>												
5.3	2005.09	2006.12	220	299	-	8		X	X	JM5442	8	system Delphi
5.3	2007.01	2010.12	220	299	-	8		X	X	JM5406	8	sys. Mitsubishi; Mexico
5.3	2007.01	2010.12	220	299	-	8		X	X	JM5439	8	sys. Delphi; Mexico
5.7 V8 350cid	2001.01	2002.12	-	-	-	8		X	X	JM5385	1	Mexico
6.0	1998.09	2006.12	224	305	-	8		X	X	JM5473	8	sys. Mitsubishi; VIN (U)
6.0	1998.09	2006.12	224	305	-	8		X	X	JM5442	8	sys. Delphi; VIN (U)
6.0	2000.09	2006.12	261	355	-	8		X	X	JM5473	8	sys. Mitsubishi; VIN (U)
6.0	2000.09	2006.12	261	355	-	8		X	X	JM5442	8	sys. Delphi; VIN (U)
6.0	2007.01	2007.12	224	305	-	8		X	X	JM5406	8	system Mitsubishi VIN (U), VIN (K)
6.0	2007.01	2007.12	224	305	-	8		X	X	JM5439	8	sys. Delphi VIN (U), VIN (K)
6.0	2007.01	2007.12	261	355	-	8		X	X	JM5406	8	system Mitsubishi VIN (U), VIN (K)
6.0	2007.01	2007.12	261	355	-	8		X	X	JM5439	8	system Delphi VIN (U), VIN (K)
6.0	2007.09	2007.12	268	364	-	8		X	X	JM5473	8	system Mitsubishi
6.0	2007.09	2007.12	268	364	-	8		X	X	JM5442	8	system Delphi
6.0	2007.09	2007.12	268	364	-	8		X	X	JM5406	8	sys. Mitsubishi VIN (K), (U)
6.0	2007.09	2007.12	268	364	-	8		X	X	JM5439	8	sys. Delphi; VIN (K), (U)
6.0 FLEX	2010.09	-->	268	364	-	8		X	X	JM5439	8	sys. Delphi; VIN (G)
6.0 FLEX	2010.09	-->	268	364	-	8		X	X	JM5406	8	sys. Mitsubishi; VIN (G)
8.1	2003.01	2007.12	254	345	-	8		X	X	JM5473	8	VIN (G)
<b>SILVERADO 3500</b>												
5.3	2007.09	2010.12	220	299	-	8		X	X	JM5406	8	sys. Mitsubishi; Mexico
5.3	2007.09	2010.12	220	299	-	8		X	X	JM5439	8	sys. Delphi; Mexico
6.0 4WD	2000.09	2006.12	224	305	-	8		X	X	JM5473	8	sys. Mitsubishi; VIN (U)
6.0 4WD	2000.09	2006.12	224	305	-	8		X	X	JM5442	8	sys. Delphi; VIN (U)
6.0	2005.09	2006.12	254	345	-	8		X	X	JM5473	8	sys. Mitsubishi; VIN (N)
6.0	2005.09	2006.12	254	345	-	8		X	X	JM5442	8	sys. Delphi; VIN (N)
6.0	2007.01	2008.12	224	305	-	8		X	X	JM5406	8	sys. Mitsubishi; VIN (K)
6.0	2007.01	2008.12	224	305	-	8		X	X	JM5439	8	sys. Delphi; VIN (K)
6.0 4WD	2007.01	2007.12	224	305	-	8		X	X	JM5406	8	sys. Mitsubishi; VIN (U)
6.0 4WD	2007.01	2007.12	224	305	-	8		X	X	JM5439	8	sys. Delphi; VIN (U)
6.0 FLEX	2011.09	-->	240	326	-	8		X	X	JM5406	8	system Mitsubishi
6.0 FLEX	2011.09	-->	240	326	-	8		X	X	JM5439	8	system Delphi
8.1	2003.01	2005.12	257	350	-	8		X	X	JM5473	8	VIN (G)
<b>SILVERADO</b>												
5.7	1994.09	1998.12	183	249	-	8		X	X	JM5385	1	Mexico
<b>SSR</b>												
6.0	2004.09	2006.12	291	390	-	8		X	X	JM5406	8	sys. Mitsubishi; VIN (H)
6.0	2004.09	2006.12	291	390	-	8		X	X	JM5439	8	sys. Delphi; VIN (H)
<b>SUBURBAN 1500</b>												
5.3	1999.09	2005.12	213	290	-	8		X	X	JM5473	8	sys. Mitsubishi; VIN (T)
5.3	1999.09	2005.12	213	290	-	8		X	X	JM5442	8	sys. Delphi; VIN (T)
5.3 Flexfuel	2005.09	2006.12	220	299	-	8		X	X	JM5473	8	sys. Mitsubishi; VIN (Z)
5.3 Flexfuel	2005.09	2006.12	220	299	-	8		X	X	JM5442	8	sys. Delphi; VIN (Z)
5.3	2006.09	2007.12	239	325	-	8		X	X	JM5406	8	sys. Mitsubishi; VIN (0), VIN (3), VIN (J)
5.3	2006.09	2007.12	239	325	-	8		X	X	JM5439	8	system Delphi; VIN (0), VIN (3), VIN (J)
5.3 Flexfuel	2007.01	2007.12	220	299	-	8		X	X	JM5406	8	sys. Mitsubishi; VIN (0), VIN (3), VIN (J)
5.3 Flexfuel	2007.01	2007.12	220	299	-	8		X	X	JM5439	8	system Delphi; VIN (0), VIN (3), VIN (J)
5.3 FLEX	2007.09	2008.12	239	325	-	8		X	X	JM5406	8	sys. Mitsubishi; VIN (0), VIN (3), VIN (J)
5.3 FLEX	2007.09	2008.12	239	325	-	8		X	X	JM5439	8	system Delphi; VIN (0), VIN (3), VIN (J)
5.3 FLEX 4WD	2007.09	2012.12	231	314	-	8		X	X	JM5406	8	sys. Mitsubishi; VIN (0), VIN (3), VIN (J)
5.3 FLEX 4WD	2007.09	2012.12	231	314	-	8		X	X	JM5439	8	system Delphi; VIN (0), VIN (3), VIN (J)
5.7	1996.01	1999.12	190	255	-	8		X	X	JM5369	1	
5.7	1996.01	1999.12	190	255	-	8		X	X	JM5385	1	sys. Mitsubishi; VIN (Y)
5.7 V8 350cid	2000.01	2002.12	-	-	-	8		X	X	JM5385	1	Mexico
6.0	2007.09	2009.12	273	366	-	8		X	X	JM5406	8	sys. Mitsubishi; VIN (Y)
6.0	2007.09	2009.12	273	366	-	8		X	X	JM5439	8	sys. Delphi; VIN (Y)



## CHEVROLET USA

SUBURBAN 2500													
5.3	1999.09	2000.12	213	290	-	8	X	X	JM5473	8	system Mitsubishi		
5.3	1999.09	2000.12	213	290	-	8	X	X	JM5442	8	system Delphi		
6.0	1999.09	2006.12	239	325	-	8	X	X	JM5473	8	system Mitsubishi		
6.0	1999.09	2006.12	239	325	-	8	X	X	JM5442	8	system Delphi		
6.0	2007.01	2007.12	239	325	-	8	X	X	JM5406	8	system Mitsubishi		
6.0	2007.01	2007.12	239	325	-	8	X	X	JM5439	8	system Delphi		
6.0	2007.09	2008.12	273	371	-	8	X	X	JM5406	8	sys. Mitsubishi; VIN (K)		
6.0	2007.09	2008.12	273	371	-	8	X	X	JM5439	8	system Delphi; VIN (K)		
6.0 FLEX	2009.09	-->	265	360	-	8	X	X	JM5406	8	sys. Mitsubishi; VIN (G)		
6.0 FLEX	2009.09	-->	265	360	-	8	X	X	JM5439	8	system Delphi; VIN (G)		
8.1	2000.09	2006.12	257	350	-	8	X	X	JM5473	8	system Mitsubishi		
TAHOE													
4.8	1999.09	2005.12	208	283	-	8	X	X	JM5473	8	sys. Mitsubishi; VIN (V)		
4.8	1999.09	2005.12	208	283	-	8	X	X	JM5442	8	sys. Delphi; VIN (V)		
4.8	2007.09	2008.12	220	299	-	8	X	X	JM5406	8	sys. Mitsubishi; VIN (C)		
4.8	2007.09	2008.12	220	299	-	8	X	X	JM5439	8	sys. Delphi; VIN (C)		
5.3	1999.09	2005.12	213	290	-	8	X	X	JM5473	8	system Mitsubishi VIN (T), VIN (Z)		
5.3	1999.09	2005.12	213	290	-	8	X	X	JM5442	8	system Delphi VIN (T), VIN (Z)		
5.3 Flexfuel	2005.09	2006.12	220	299	-	8	X	X	JM5473	8	system Mitsubishi VIN (T), VIN (Z)		
5.3 Flexfuel	2005.09	2006.12	220	299	-	8	X	X	JM5442	8	system Delphi VIN (T), VIN (Z)		
5.3	2006.09	2007.12	239	325	-	8	X	X	JM5406	8	system Mitsubishi VIN (O), VIN (J)		
5.3	2006.09	2007.12	239	325	-	8	X	X	JM5439	8	system Delphi VIN (O), VIN (J)		
5.3 Flexfuel	2007.09	2008.12	239	325	-	8	X	X	JM5406	8	sys. Mitsubishi VIN (O), VIN (3), VIN (J)		
5.3 Flexfuel	2007.09	2008.12	239	325	-	8	X	X	JM5439	8	system Delphi VIN (O), VIN (3), VIN (J)		
5.7	1996.01	2000.12	151	205	-	8	X	X	JM5385	1	VIN (R)		
5.7	1996.01	2000.12	193	262	-	8	X	X	JM5385	1	VIN (R)		
6.0	2008.01	2012.12	-	-	-	8	X	X	JM5406	8	system Mitsubishi VIN (5), VIN (J)		
6.0	2008.01	2012.12	-	-	-	8	X	X	JM5439	8	system Delphi VIN (5), VIN (J)		
6.0	2011.09	-->	248	332	-	8	X	X	JM5406	8	system Mitsubishi		
6.0	2011.09	-->	248	332	-	8	X	X	JM5439	8	system Delphi		
6.2	2007.09	2009.12	293	393	-	8	X	X	JM5406	8	system Mitsubishi VIN (8), VIN (2)		
6.2	2007.09	2009.12	293	393	-	8	X	X	JM5439	8	system Delphi VIN (8), VIN (2)		
TRACKER													
1.6	1999.01	2000.12	71	97	-	4	X	X	JM5472	2	VIN (6) OE 33410-66D10		
TRAILBLAZER													
4.2	1996.01	2007.12	205	275	-	6	-	-	JM5405	6	VIN (S)		
5.3	2003.09	2004.12	224	305	-	8	X	X	JM5473	8	sys. Mitsubishi; VIN (P)		
5.3	2003.09	2004.12	224	305	-	8	X	X	JM5442	8	sys. Delphi; VIN (P)		
5.3	2005.01	2006.12	224	305	-	8	X	X	JM5406	8	sys. Mitsubishi; VIN (M)		
5.3	2005.01	2006.12	224	305	-	8	X	X	JM5439	8	sys. Delphi; VIN (M)		
6.0	2005.09	2006.12	295	401	-	8	X	X	JM5406	8	sys. Mitsubishi; VIN (H)		
6.0	2005.09	2006.12	295	401	-	8	X	X	JM5439	8	sys. Delphi; VIN (H)		
TRAVERSE													
3.6	2008.09	2009.12	210	286	-	6	-	-	JM5426	6	OE 12613057		
UPLANDER													
3.5	2004.09	2006.12	149	203	-	6	X	X	JM5496	1	VIN (L)		
3.9	2005.09	2008.12	179	243	-	6	X	X	JM5496	1	VIN (1), VIN (W)		
VECTRA													
2.8	2006.09	2008.12	186	250	-	6	-	-	JM5426	6	Mexico; OE 12629037		
CHRYSLER													
300 C													
2.7	2005.01	2012.11	142	193	2.7FX, EER	6	-	-	JM5428	6	OE 4609095AG		
2.7	2006.01	2012.11	142	193	2.7FX, EER	6	-	-	JM5375	6	OE 4606869AB		
2.7	2007.01	2012.11	130	177	EES	6	-	-	JM5375	6	OE 4606869AB		
2.7	2007.01	2012.11	130	177	EES	6	-	-	X	6	OE 4609095AG		
3.5	2004.09	2005.12	183	249	3.5CSP	6	-	-	JM5429	6	OE 4609088AF		
3.5	2006.01	2012.11	183	249	3.5CSP	6	-	-	JM5375	6	OE 4606869AB		



<b>CHRYSLER</b>											
<b>300 C</b>											
5.7	2004.09	2005.12	250	340	EZB, EZD, EZH	8		X	X	JM5281	8
5.7	2006.01	2012.11	250	340	EZB, EZD, EZH	8	-	-	-	JM5422	8
6.1 SRT8	2005.06	2010.12	317	431	ESF	8	-	-	-	JM5422	8
<b>AVENGER</b>											
1.6	1978.01	1980.12	60	82	-	4	-	X	X	JM5335	1 for BOSCH GT40T R1=3.0[Ω], R2=8.5[kΩ]
<b>CENTURA</b>											
2.0	1975.01	1978.12	-	-	18	4	-	X	X	JM5334	1 GT40RT
3.5	1975.01	1979.12	-	-	-	6	-	X	X	JM5334	1 GT40RT
4.0	1975.01	1979.12	-	-	-	6	-	X	X	JM5334	1 GT40RT
<b>CH series</b>											
4.3 265 cu.in	1972.01	1973.12	-	-	-	6	-	X	X	JM5334	1 GT40RT
<b>CIRRUS</b>											
2.0 LX	1994.05	1997.09	96	131	-	4	-	X	X	JM5071	1
2.0 LX	1997.10	2000.09	98	133	ECB	4	-/4	AM74	AMU74	JM5071	1
2.4 LX	1994.05	2000.09	103	140	EDZ	4	-/4	AM15	AMU15	JM5071	1
2.5 LX	1994.10	2000.09	120	163	EEB	6	-/6	JP171	JPE171	JM5305	1 Dist. T5T57172
<b>CJ series</b>											
4.3 265 cu.in	1973.01	1975.12	-	-	-	6	-	X	X	JM5334	1 GT40RT
<b>CONCORDE</b>											
3.3 LX	1992.10	1997.09	120	163	-	6	-/6	AM10	AMU10	X	-
3.5 LX	1992.10	1997.09	155	211	-	6	-/6	AM10	AMU10	X	-
3.8	1992.10	1997.09	-	-	-	6	-/6	AM10	AMU10	X	-
<b>CROSSFIRE</b>											
3.2	2003.07	2007.12	160	218	EGX	6	-/12	M19	-	JM5041	6
3.2	2004.09	2007.12	246	335	EGZ	6	-/12	M19	-	JM5041	6
<b>GAZ</b>											
2.4 (31105 16V)	-	-	-	-	-	4	-/4	AM79	AMU79	X	-
<b>HUNTER</b>											
	1978.01	1980.12	-	-	-	4		X	X	JM5335	1 for BOSCH GT40T R1=3.0[Ω], R2=8.5[kΩ]
<b>LASER</b>											
2.2 i	1983.08	1986.07	74	-	D/E EFI	4	1/4	AM72	AMU72	X	-
2.2 lt	1983.08	1986.07	106	-	D/E EFI	4	1/4	AM72	AMU72	X	-
<b>LE BARON</b>											
2.2 i	1986.09	1994.12	69	94	-	4	1/4	AM72	AMU72	X	-
2.2 i Turbo	1986.09	1990.12	109	148	-	4	1/4	AM72	AMU72	X	-
2.2 i Turbo	1986.09	1991.01	130	177	EDR	4	1/4	AM72	AMU72	X	-
2.5 i	1986.09	1994.12	75	101	EDM	4	1/4	AM72	AMU72	X	-
2.5 i Turbo	1989.01	1994.12	112	152	EDT	4	1/4	AM72	AMU72	X	-
3.0 i V6	1990.01	1994.12	105	143	EFA	6	2/6	AM60	AMU60	X	-
3.0 i V6	1990.01	1996.12	105	143	6G72	6	2/6	AM60	AMU60	X	-
3.0 i V6	1990.01	1993.12	105	143	-	6	2/6	AM60	AMU60	JM5129	1
<b>LHS</b>											
3.5	1994.01	1997.12	189	257	-	6	-/6	AM10	AMU10	JM5072	1
3.5	1999.01	2001.12	189	257	-	6	-	-	-	JM5429	6
<b>NEON</b>											
1.6	2001.11	2006.12	85	116	EJD	4	-/4	HR15	-	X	-
1.8 16V	1997.09	1999.08	85	116	-	4	-/4	AM74	AMU74	JM5071	1
2.0 16V	1994.05	1999.08	98	133	420H	4	-/4	AM74	AMU74	JM5071	1
2.0 16V	1994.06	1999.08	107	145	ECC	4	-/4	AM15	AMU15	JM5071	1
2.0 16V	1996.04	1999.08	109	148	420T	4	-/4	AM15	AMU15	JM5071	1
2.0 16V	1999.08	-->	98	133	420H	4	-/4	HR15	-	JM5070	1
2.0 16V R/T	2001.10	2006.12	110	150	-	4	-/4	AM74	AMU74	JM5070	1
<b>NEW YORKER</b>											
2.2 i	1983.09	1988.08	75	102	D, E	4	1/4	AM72	AMU72	X	-
2.5 i	1983.09	1988.08	109	-	K	4	1/4	AM72	AMU72	X	-
3.0 i	1987.09	1992.08	101	136	3 TBI	6	2/6	AM60	AMU60	X	-
3.3	1989.09	1993.12	110	150	-	6	-/6	AM10	AMU10	X	-
3.5 i 24V	-	1998.09	155	211	F01	6	1/6	AM78	AMU78	X	-
<b>PACIFICA</b>											
4.0	2006.06	2008.09	191	260	EMM	6	-	-	-	JM5375	6 OE 4606869AB
<b>PT CRUISER</b>											
1.6	2001.11	2010.12	85	116	EJD	4	-/4	HR15	-	JM5070	1
2.0	2000.06	2010.12	104	141	ECC	4	-/4	AM73	AMU73	JM5070	1
2.0	2004.10	2010.12	100	136	ECC	4	-/4	AM73	AMU73	JM5070	1



CHRYSLER											
<b>PT CRUISER</b>											
2.4	2000.06	2010.12	110	150	EDZ	4	-/4	AM73	AMU73	JM5070	1
2.4 GT	2003.08	2010.12	164	223	EDV	4	-/4	AM73	AMU73	JM5071	1
2.4	2004.03	2010.12	105	143	EDZ	4	-/4	AM73	AMU73	JM5070	1
<b>RV1</b>											
225 cu.in	1962.01	1962.12	-	-	-	6		X	X	JM5334	1 GT40RT
<b>SEBRING</b>											
2.0	1995.01	1998.12	96	131	-	4		X	X	JM5071	1
2.0	1995.05	2000.09	96	131	ECB	4	-/4	AM74	AMU74	X	-
2.0	2001.04	2007.06	104	141	ECC	4	-/4	AM73	AMU73	JM5070	1
2.0 VVT	2007.07	2010.12	115	156	ECN	4	-	-	-	JM5404	4
2.4	2001.04	2007.06	112	152	EDZ	4	-/4	AM73	AMU73	JM5071	1
2.4 VVT	2007.07	2010.12	125	170	-	4	-	-	-	JM5404	4 VIN (K), VIN (J), VIN (B)
2.5 LE	1995.05	2000.09	120	163	EEB	6	-/6	JP171	JPE171	JM5305	1 Dist. T5T57172
2.7 V6 24V	2001.04	2007.06	149	203	EES	6	-	-	-	JM5428	6
2.7	2007.07	2010.12	137	186	-	6	-	-	-	JM5375	6
<b>STRATUS</b>											
2.0 LE	1995.12	2001.04	96	131	C00	4	-/4	AM74	AMU74	JM5070	1
2.0 16V	1995.12	-->	98	133	ECB	4	-/4	AM74	AMU74	JM5071	1
2.0 LE	1996.06	2001.04	96	131	420X	4	-/4	AM74	AMU74	JM5070	1
2.4 16 V	1995.12	2001.04	103	140	EDZ	4	-/4	AM15	AMU15	JM5071	1
2.4 16V	1995.12	-->	112	152	EDZ	4	-/4	AM15	AMU15	JM5071	1
2.5 LX V6	1995.12	2001.04	120	163	EEB, H00	6	-/6	JP171	JPE171	JM5305	1 Dist. T5T57172
2.5 V6	1995.12	-->	125	170	H00	6	-/6	JP171	JPE171	JM5305	1 Dist. T5T57172
2.5 LX	1996.04	2001.04	120	163	625H	6	-/6	JP171	JPE171	JM5305	1 Dist. T5T57172
<b>SV1</b>											
225 cu.in.	1962.01	1962.12	-	-	-	6		X	X	JM5334	1 GT40RT
<b>TOWN &amp; COUNTRY</b>											
2.2 i	1988.09	1999.12	149	-	R (EDD)	4	1/4	AM72	AMU72	X	-
3.0 i	1989.09	1999.12	105	-	6G72	6	2/6	AM60	AMU60	X	-
3.3	-	-	-	-	-	6	-/6	AM10	AMU10	X	-
3.8	2000.10	2006.09	160	218	EGH	6	-/6	AM10	AMU10	X	-
<b>VALIANT</b>											
1.3	1970.01	1972.12	-	-	4G30, 4G31	4		X	X	JM5335	1 for BOSCH GT40T R1=3.0[Ω], R2=8.5[kΩ]
1.4	1972.01	1975.12	-	-	4G32, 4G33	4		X	X	JM5335	1 for BOSCH GT40T R1=3.0[Ω], R2=8.5[kΩ]
1.5	1970.01	1972.12	-	-	4G30, 4G31	4		X	X	JM5335	1 for BOSCH GT40T R1=3.0[Ω], R2=8.5[kΩ]
1.6	1972.01	1975.12	-	-	4G32, 4G33	4		X	X	JM5335	1 for BOSCH GT40T R1=3.0[Ω], R2=8.5[kΩ]
1.6	1975.01	1977.12	-	-	4G32, 4G33	4		X	X	JM5335	1 for BOSCH GT40T R1=3.0[Ω], R2=8.5[kΩ]
1.6	1977.01	1979.12	-	-	4G32, 4G33	4		X	X	JM5335	1 for BOSCH GT40T R1=3.0[Ω], R2=8.5[kΩ]
3.5	1973.01	1976.12	-	-	215 cu.in	6		X	X	JM5334	1 GT40RT
3.7	1963.01	1966.12	-	-	225 cu.in	6		X	X	JM5334	1 GT40RT
3.7	1963.01	1966.12	-	-	225 cu.in	6		X	X	JM5334	1 GT40RT
3.7	1967.01	1969.12	-	-	-	6		X	X	JM5334	1 GT40RT
4.0	1970.01	1973.12	-	-	-	6		X	X	JM5334	1 GT40RT
4.3	1965.01	1966.12	-	-	273 cu.in	8		X	X	JM5334	1 GT40RT
4.3	1965.01	1966.12	-	-	273 cu.in	8		X	X	JM5334	1 GT40RT
4.3	1965.01	1966.12	-	-	273 cu.in	8		X	X	JM5334	1 GT40RT
4.3	1971.01	1973.12	-	-	265 cu.in	6		X	X	JM5334	1 GT40RT
5.2	1968.01	1973.12	-	-	318 cu.in	8		X	X	JM5334	1 GT40RT
5.2	1974.01	1979.12	-	-	-	8		X	X	JM5334	1 GT40RT
<b>VOYAGER</b>											
2.0 i	1995.01	2001.03	98	133	C00	4	-/4	AM74	AMU74	JM5070	1
2.0 i	1995.01	2001.03	98	133	C00	4	1/4	AM70	AMU70	X	-
2.4 i	1995.01	1997.01	111	151	B00	4	1/4	AM70	AMU70	JM5287	1
2.4 AWD	1997.02	2001.03	111	151	-	4	1/4	AM71	AMU71	JM5070	1
2.4 AWD	1997.02	2001.03	111	151	EDZ	4		X	X	JM5287	1
2.4 i	1997.02	2000.09	111	151	B00	4	-/4	AM79	AMU79	JM5070	1
2.4	2000.02	2008.12	108	147	EDZ	4	-/4	AM73	AMU73	JM5070	1
2.4 i	2000.10	2001.03	111	151	B00	4	-/4	AM74	AMU74	JM5070	1
2.5 i	1990.08	1995.09	74	101	K	4	1/4	AM72	AMU72	X	-
2.5 i	1991.01	1995.09	72	98	K00	4	1/4	AM72	AMU72	JM5288	1
3.0 i	1991.01	1995.09	108	147	300, 6G72	6	1/6	AM67	AMU67	JM5129	1
3.3	1989.10	1990.09	112	152	EGA	6	-/6	AM69	AMU69	JM5070	1 OE 4443971



## CHRYSLER

VOYAGER												
3.3	1989.10	1990.09	112	152	EGA	6	-/6	AM69	AMU69	JM5388	1	OE 4609140AB
3.3 i	1990.08	1995.09	110	150	EGA	6	-/6	AM69	AMU69	JM5072	1	OE 4443971
3.3 i	1990.08	1995.09	120	163	EGA	6	-/6	AM69	AMU69	JM5072	1	OE 4443971
3.3 iAWD	1990.08	1995.09	120	163	R00	6	-/6	AM69	AMU69	JM5072	1	OE 4443971
3.3 i	1999.01	2001.03	116	158	R00	6	-/6	AM68	AMU68	JM5388	1	
3.3	2000.02	2000.12	128	174	EGA	6	-/6	AM68	AMU68	JM5388	1	VIN (G)
3.3	2000.02	2000.12	128	174	EGA	6	-/6	AM68	AMU68	JM5388	1	VIN (R)
3.3 Flex-Fuel	2000.02	2000.12	128	174	EGM	6	-/6	AM68	AMU68	JM5388	1	VIN (G)
3.3 Flex-Fuel	2000.02	2000.12	128	174	EGM	6	-/6	AM68	AMU68	JM5388	1	VIN (R)
3.3 Flex-Fuel	2000.02	2008.12	128	174	EGM	6	-/6	AM75	AMU75	X	-	
3.3	2001.01	2004.12	128	174	EGA	6	-/6	AM75	AMU75	JM5443	1	
3.8 iAWD	1999.01	2001.03	122	166	L00	6	-/6	AM68	AMU68	JM5388	1	
3.8 iAWD	2000.01	2001.03	131	178	EGH	6	1/6	AM78	AMU78	X	-	OE 4609140AB VIN (G)
3.8 iAWD	2000.01	2001.03	131	178	EGH	6	1/6	AM78	AMU78	X	-	OE 4609140AB; VIN (R)
3.8	2001.01	2008.12	160	218	EGH	6	-/6	AM75	AMU75	JM5443	1	

## CHRYSLER USA

200												
2.4	2010.09	-->	129	173	-	4	-	-	-	JM5404	4	
300												
2.7 24V	2006.01	2009.12	142	193	-	6	-	-	-	JM5375	6	VIN (R), VIN (D)
3.5 24V	2006.01	2008.12	187	254	-	6	-	-	-	JM5375	6	VIN (G), VIN (V)
5.7	2004.09	2007.12	254	345	-	8		X	X	JM5281	8	VIN (H)
ASPEN LIMITED												
4.7	2006.09	2007.12	175	238	-	8		X	X	JM5286	8	VIN (P), VIN (N)
CIRRUS												
2.4	1994.09	2000.12	112	152	-	4		X	X	JM5071	1	VIN (X)
2.4	1994.09	2000.12	112	152	-	4		X	X	JM5070	1	VIN (X)
2.4	2000.09	2007.04	112	152	-	4		X	X	JM5070	1	VIN (X)
2.5 24V	1995.01	2000.12	125	170	-	6		X	X	JM5305	1	Dist. T5T57172
CONCORDE												
3.3 V6 OHV 201 cid.	1993.01	-->	-	-	-	6		X	X	JM5072	1	VIN (T)
3.3 V6 FLEX OHV 201 cid.	1994.01	1995.12	-	-	-	6		X	X	JM5072	1	VIN (U)
3.5 V6 SOHC 215 cid.	1993.01	1997.12	-	-	-	6		X	X	JM5072	1	VIN (F)
CORDOBA												
6.6	1974.09	1978.12	123	167	-	8	1/8	AM98	AMU98	X	-	
6.6 V8 400cid	1975.01	1978.12	-	-	-	8		X	X	JM5613	1	
DYNASTY												
3.3	1990.09	1993.12	75	102	-	6		X	X	JM5072	1	VIN (T)
GRAND VOYAGER												
3.3	1999.09	2000.12	130	176	-	6		X	X	JM5388	1	VIN (G), VIN (R)
IMPERIAL												
3.3	1989.09	1991.12	110	150	-	6		X	X	JM5072	1	VIN (R)
3.8	1990.09	1993.12	112	152	-	6		X	X	JM5072	1	VIN (L)
7.2	1974.09	1975.12	160	218	-	8		X	X	JM5613	1	
INTREPID												
3.3	1993.09	1995.12	120	163	-	6		X	X	JM5072	1	VIN (T)
3.3	1992.09	1997.12	121	164	-	6		X	X	JM5072	1	VIN (U)
3.3 V6 OHV 201 cid.	1997.01	-->	-	-	EGB	6		X	X	JM5072	1	VIN (T)
3.5	1992.09	1997.12	120	163	-	6		X	X	JM5072	1	VIN (T)
3.5 V6 SOHC 215 cid.	1997.01	-->	-	-	EGE	6		X	X	JM5072	1	VIN (F)
LEBARON												
3.7	1977.09	1981.12	68	92	-	6	1/6	AM101	AMU101	X	-	
LHS												
3.5	1993.09	1997.12	160	218	-	6		X	X	JM5072	1	VIN (F)
NEW YORKER												
3.3 V6 OHV 201 cid.	1990.01	1993.12	-	-	-	6		X	X	JM5072	1	VIN (R)
3.5	1993.09	1996.12	160	218	-	6		X	X	JM5072	1	VIN (F)
3.8	1990.09	1993.12	112	152	-	6		X	X	JM5072	1	VIN (L)
6.6	1974.09	1978.12	131	178	-	8	1/8	AM98	AMU98	X	-	
6.6 V8 400cid	1975.01	1978.12	-	-	-	8		X	X	JM5613	1	
7.2	1974.09	1978.12	146	199	-	8		X	X	JM5613	1	
NEWPORT												
6.6	1971.09	1974.12	138	188	-	8	1/8	AM98	AMU98	X	-	
6.6 V8 400cid	1973.01	1978.12	-	-	-	8		X	X	JM5613	1	



CHRYSLER USA												
<b>NEWPORT</b>												
6.6	1974.09	1978.12	131	178	-	8	1/8	AM98	AMU98	X	-	
7.2	1974.09	1978.12	146	199	-	8		X	X	JM5613	1	
<b>PACIFICA</b>												
4.0 24V	2007.01	2007.12	190	258	-	6	-	-	-	JM5375	6	VIN (X)
<b>PT CRUISER</b>												
2.4	2000.09	2008.12	112	152	-	4		X	X	JM5070	1	VIN (B)
2.4	2007.09	2009.12	134	182	-	4		X	X	JM5070	1	VIN (8)
<b>SEBRING</b>												
2.0	1995.09	1998.12	104	141	-	4		X	X	JM5071	1	VIN (Y)
2.4 DOHC 148 cid.	1997.01	1998.12	-	-	EDZ	4		X	X	JM5070	1	VIN (X)
2.4 SOHC	2001.01	2005.12	104	140	-	4	-/2	JP200	-	JM5121	2	JM1185 or JM1194 VIN (G)
2.4 DOHC 148 cid.	2001.01	2005.12	-	-	-	4		X	X	JM5070	1	VIN (X), VIN (J)
2.4 SOHC	2005.01	-->	-	-	-	4	-/2	JP200	-	JM5121	2	JM1185 or JM1194 VIN (G)
2.4	2006.09	2010.12	128	172	-	4	-	-	-	JM5404	4	VIN (K), VIN (B)
2.4 AWD	2006.09	2010.12	128	172	-	4	-	-	-	JM5404	4	VIN (J)
2.5 24V	1995.01	2000.12	122	166	-	6		X	X	JM5305	1	Dist. T5T57172
2.7 24V	2001.01	2006.12	151	205	-	6	-	-	-	JM5375	6	01.2006 - 12.2006 VIN (R), VIN (T)
2.7 V6	2007.01	2010.12	-	-	-	6		X	X	JM5375	6	VIN (R), VIN (D)
3.0 24V	2001.01	2005.12	148	201	-	6		X	X	JM5317	1	Dist. T0T58171
3.0 24V	2001.01	2005.12	151	205	-	6		X	X	JM5317	1	Dist. T0T58171
3.0 24V	2001.01	2003.12	149	203	-	6		X	X	JM5317	1	Dist. T0T58171
3.5 V6	2007.09	2008.12	175	238	12.2008	6		X	X	JM5375	6	VIN (M), VIN (V)
3.5 V6	2008.09	2010.12	175	238	12.2010	6		X	X	JM5375	6	VIN (M), VIN (V)
<b>TOWN &amp; COUNTRY</b>												
3.3	1989.09	1993.12	112	152	-	6		X	X	JM5072	1	VIN (R)
3.3	1995.09	2000.12	112	152	-	6		X	X	JM5072	1	VIN (R)
3.3 Flexfuel	1997.09	2000.12	118	160	-	6		X	X	JM5072	1	VIN (R)
3.7	1977.09	1981.12	84	114	-	6	1/6	AM101	AMU101	X	-	
3.8	1993.09	1994.12	121	165	-	6		X	X	JM5072	1	VIN (L)
3.8	1994.09	2000.12	121	165	-	6		X	X	JM5072	1	VIN (L)
4.0 V6	2008.01	2010.12	-	-	-	6		X	X	JM5375	6	VIN (X)
6.6	1971.09	1972.12	142	193	-	8	1/8	AM98	AMU98	X	-	
6.6	1974.09	1977.12	131	178	-	8	1/8	AM98	AMU98	X	-	
6.6 V8 400cid	1975.01	1977.12	-	-	-	8		X	X	JM5613	1	
7.2	1974.09	1977.12	146	199	-	8		X	X	JM5613	1	
<b>VOYAGER</b>												
2.4	1999.09	2003.12	112	152	-	4		X	X	JM5070	1	VIN (B)
3.3	1999.09	2000.12	116	158	-	6		X	X	JM5388	1	VIN (G), VIN (R)
<b>DAEWOO USA</b>												
<b>LANOS</b>												
1.5 FI	1999.01	2002.12	-	-	-	4		X	X	JM5038	1	
1.6	1998.09	2002.12	78	106	-	4		X	X	JM5038	1	
1.6 98 cid.	1998.09	2002.12	-	-	-	4		X	X	JM5038	1	VIN (6); VIN (Y)
<b>LEGANZA</b>												
2.2	1998.09	2002.12	98	133	-	4		X	X	JM5038	1	4-PINS OE 96350585
2.2 DOHC	1998.09	2002.12	-	-	-	4		X	X	JM5038	1	VIN (2)
<b>NUBIRA</b>												
2.0	1998.09	2002.12	96	131	-	4		X	X	JM5038	1	4-PINS; [-ULEV] OE 96350585
2.0	2000.01	2002.12	96	131	-	4		X	X	JM5079	1	3-PINS; [+ULEV] OE 96253555
<b>DODGE</b>												
<b>600</b>												
2.2 i	1984.09	1988.08	72	-	EFI (EDM)	4	1/4	AM72	AMU72	X	-	
2.5 i	1984.09	1988.08	109	-	EFI (EDM)	4	1/4	AM72	AMU72	X	-	
<b>AVENGER</b>												
2.0	1995.01	1998.12	104	141	-	4		X	X	JM5071	1	
2.0	2007.06	-->	115	156	ECN	4	-	-	-	JM5404	4	
2.4	2007.06	2008.12	125	170	-	4	-	-	-	JM5404	4	VIN (K), VIN (J)
2.4	2007.06	2008.12	129	175	ED3, EDG	4	-	-	-	JM5404	4	VIN (K)
2.4	2008.01	2008.12	129	175	ED3, EDG	4	-	-	-	JM5404	4	VIN (J)



## DODGE

### AVENGER

2.4	2009.01	-->	125	170	-	4	-	-	-	JM5404	4	VIN (B)
2.4	2009.01	-->	129	175	ED3, EDG	4	-	-	-	JM5404	4	VIN (B)
2.7	2007.06	-->	137	186	EER	6	-	-	-	JM5375	6	
2.7 Flex-Fuel	2007.06	-->	139	189	-	4	-	-	-	JM5375	4	

### CALIBER

1.8	2006.06	2009.12	110	150	EBA	4	-	-	-	JM5404	4	VIN (C)
2.0	2006.06	2008.12	115	156	ECN	4	-	-	-	JM5404	4	VIN (K)
2.0	2006.06	2011.12	115	156	ECN	4	-	-	-	JM5404	4	VIN (B)
2.0	2008.01	2009.12	115	156	ECN	4	-	-	-	JM5404	4	VIN (F)
2.4	2006.10	2008.12	125	170	ED3	4	-	-	-	JM5404	4	VIN (B)
2.4 VVT AWD	2006.10	2008.12	223	303	ED4	4	-	-	-	JM5404	4	VIN (K)
2.4 Turbo	2007.12	2009.12	217	295	ED4	4	-	-	-	JM5404	4	VIN (F)
2.4	2009.01	-->	125	170	ED3	4	-	-	-	JM5404	4	VIN (A)

### CANTER T93, T97

2.3	1971.01	1976.12	-	-	KE47	4		X	X	JM5334	1	GT40RT
-----	---------	---------	---	---	------	---	--	---	---	--------	---	--------

### CARAVAN

2.0 i	1995.01	2001.03	98	133	-	4		X	X	JM5287	1	
2.4 i	1995.01	2001.03	111	151	EDZ	4		X	X	JM5287	1	
2.4	2000.02	2007.12	111	151	EDZ	4		X	X	JM5287	1	
2.5 i	1988.01	1995.09	109	-	EFI (EDM)	4	1/4	AM72	AMU72	X	-	
3.3 i	1999.01	2001.03	116	158	EGP	6	-/6	AM68	AMU68	JM5388	1	VIN (G), VIN (R) OE 4609140AB
3.3	2000.02	2000.12	128	174	EGA	6	-/6	AM68	AMU68	JM5388	1	VIN (G), VIN (R)
3.3 AWD	2000.02	2000.12	128	174	EGA	6	-/6	AM68	AMU68	JM5388	1	VIN (G), VIN (R)
3.3	2001.01	2007.12	128	174	EGA	6		X	X	JM5443	1	
3.3 AWD	2001.01	2007.12	128	174	EGA	6		X	X	JM5443	1	
3.8 i	1999.01	1999.12	122	166	EGH	6	-/6	AM68	AMU68	JM5388	1	VIN (L); OE 4609140AB
3.8 i	1999.01	1999.12	131	178	EGH	6	-/6	AM68	AMU68	JM5388	1	VIN (L); OE 4609140AB
3.8 i AWD	1999.01	1999.12	122	166	EGH	6	-/6	AM68	AMU68	JM5388	1	VIN (L); OE 4609140AB
3.8 i AWD	1999.01	1999.12	131	178	EGH	6	-/6	AM68	AMU68	JM5388	1	VIN (L); OE 4609140AB
3.8	2001.01	2007.12	160	218	EGH	6		X	X	JM5443	1	
3.8 AWD	2001.01	2007.12	160	218	EGH	6		X	X	JM5443	1	
3.8 Turbo AWD	2001.04	2007.12	153	208	EGH	6		X	X	JM5443	1	

### D5N 245-1

4.0	1973.01	1979.12	-	-	D613	6		X	X	JM5334	1	GT40RT
-----	---------	---------	---	---	------	---	--	---	---	--------	---	--------

### D5N 318, 360

5.2	1973.01	1979.12	-	-	-	8		X	X	JM5334	1	GT40RT
-----	---------	---------	---	---	---	---	--	---	---	--------	---	--------

### DAYTONA

2.2 i	1991.09	2000.12	112	-	EFI (EDT)	4	1/4	AM72	AMU72	X	-	
2.5 i	1991.09	2000.12	167	-	EFI (EDS)	4	1/4	AM72	AMU72	X	-	
3.0 i	1992.08	2000.12	105	-	EFA 6G72	6	2/6	AM60	AMU60	X	-	

### DURANGO

3.7	2003.11	2010.12	157	213	EKG	6		X	X	JM5281	6	
4.7 AWD	2003.11	2010.12	172	234	EVA	8		X	X	JM5281	8	
4.7 ST	2003.11	2010.12	172	234	-	8		X	X	JM5281	8	
5.7 SLT Hemi AWD	2003.11	2010.12	257	349	EZA	8	-/8	AM90	AMU90	JM5281	8	

### DYNASTY

2.5 i	1987.09	1993.08	74	-	K TBI	4	1/4	AM72	AMU72	X	-	
3.0 i	1987.09	1993.08	104	141	3MPI (EFA)	6	2/6	AM60	AMU60	X	-	

### GRAND CARAVAN

2.5 i	1988.01	1993.08	72	-	EFI (EDM)	4	1/4	AM72	AMU72	X	-	
3.0 i	1988.01	1994.12	104	-	EFI (EFA)	6	2/6	AM60	AMU60	X	-	
4.0	2007.06	-->	173	235	EMM	6	-	-	-	JM5375	6	

### INTREPID

3.5	1992.10	1998.12	160	218	-	6	-/6	AM10	AMU10	X	-	
-----	---------	---------	-----	-----	---	---	-----	------	-------	---	---	--

### JOURNEY

2.4	2009.01	-->	125	170	ED3	4	-	-	-	JM5404	4	VIN (B)
2.4 ECO+	2009.03	-->	125	170	-	4	-	-	-	JM5404	4	VIN (B)
3.5	2008.06	-->	173	235	EGF	6	-	-	-	JM5375	6	
3.5 AWD	2008.06	-->	173	235	EGF	6	-	-	-	JM5375	6	

### LANCER

2.2 i	1987.09	1989.08	109	-	AMPI	4	1/4	AM72	AMU72	X	-	
-------	---------	---------	-----	---	------	---	-----	------	-------	---	---	--

### NEON

2.0 16V	1994.05	1999.08	98	133	ECB	4	-/4	AM13	AMU13	X	-	
2.0 16V	1994.05	1999.08	98	133	ECB	4		X	X	JM5287	1	





## DODGE

Model	Year 1	Year 2	Power (kW)	Power (kM)	Engine	Cylinders	Transmission	Engine Code	Engine Code	Engine Code	Engine Code	Notes
<b>NEON</b>												
2.0 16V	1994.06	1999.08	107	145	-	4		X	X	JM5287	1	
2.0 16V	1996.04	1999.08	109	148	ECC	4		X	X	JM5287	1	
2.0 16V	1996.04	1999.08	112	152	-	4		X	X	JM5287	1	
2.0 16V	1999.08	-->	98	133	ECB	4		X	X	JM5287	1	
2.0 16V	1999.08	-->	112	152	-	4		X	X	JM5287	1	
<b>NITRO</b>												
4.0 4WD	2007.06	-->	191	260	EGS	6	-	-	-	JM5375	6	
<b>PHOENIX 318</b>												
5.2	1970.01	1973.12	-	-	318 cu.in.	8		X	X	JM5334	1	GT40RT
<b>PHOENIX HARDTOP 383</b>												
6.3	1970.01	1973.12	-	-	383 cu.in.	8		X	X	JM5334	1	GT40RT
<b>RAM</b>												
3.9	1997.01	1997.12	-	-	-	6	1/6	AM59	AMU59	X	-	
<b>SHADOW</b>												
2.2 i	1986.09	1994.08	69	-	D TBI (EDF)	4	1/4	AM72	AMU72	X	-	
2.5 i	1986.09	1994.08	74	-	K TBI (EDM)	4	1/4	AM72	AMU72	X	-	
<b>SPIRIT</b>												
2.5 i	1988.10	1993.08	74	-	4 TBI (EDM)	4	1/4	AM72	AMU72	X	-	
2.5 iT	1988.10	1993.08	107	-	J MPI	4	1/4	AM72	AMU72	X	-	
3.0 i	1988.10	1995.08	104	-	3 MPI (EFA)	6	2/6	AM60	AMU60	X	-	
<b>STRATUS</b>												
2.0 16V	1995.12	2001.04	98	133	ECB	4		X	X	JM5287	1	
2.4 16 V	1995.12	2001.04	103	140	-	4		X	X	JM5287	1	
2.4 16V	1995.12	2001.04	112	152	EDZ	4		X	X	JM5287	1	
2.5 V6	1995.12	2001.04	125	170	EEB	6		X	X	JM5305	1	Dist. T5T57172
<b>VIPER COUPE</b>												
8.0 RT10	1997.10	2002.09	282	383	EWB	10		X	X	JM5070	1	4 plug coil; VIN (E)
8.0 RT10	1997.10	2002.09	282	383	EWB	10		X	X	JM5458	1	6 plug coil; VIN (E)
8.0 RT10 ACR	1997.10	2002.09	335	455	EWB	10		X	X	JM5070	1	4 plug coil; VIN (E)
8.0 RT10 ACR	1997.10	2002.09	335	455	EWB	10		X	X	JM5458	1	6 plug coil; VIN (E)
<b>VIPER KABRIOLET</b>												
8.0 RT10	1997.10	2002.09	282	383	EWB	10		X	X	JM5070	1	4 plug coil; VIN (E)
8.0 RT10	1997.10	2002.09	282	383	EWB	10		X	X	JM5458	1	6 plug coil; VIN (E)
8.0 RT10 ACR	1997.10	2002.09	335	455	EWB	10		X	X	JM5070	1	4 plug coil; VIN (E)
8.0 RT10 ACR	1997.10	2002.09	335	455	EWB	10		X	X	JM5458	1	6 plug coil; VIN (E)
<b>VIPER KABRIOLET SRT-10</b>												
8.3	2003.11	2006.12	372	506	-	10		X	X	JM5070	1	4 plug coil; VIN (Z)
8.3	2003.11	2006.12	372	506	-	10		X	X	JM5458	1	6 plug coil; VIN (Z)
<b>DODGE USA</b>												
<b>ASPEN</b>												
3.7	1975.09	1978.12	67	91	-	6	1/6	AM101	AMU101	JM5613	1	
<b>AVENGER</b>												
2.0 DOHC 122 cid.	1995.01	1999.12	-	-	ECF	4		X	X	JM5070	1	VIN (Y)
2.0 DOHC 122 cid.	1995.01	1999.12	-	-	ECF	4		X	X	JM5071	1	VIN (Y)
2.0 DOHC 122 cid.	1996.01	-->	-	-	ECF	4		X	X	JM5071	1	VIN (Y)
2.4	2007.06	2008.12	129	175	-	4	-	-	-	JM5404	4	VIN (K)
2.4	2008.01	2008.12	129	175	-	4	-	-	-	JM5404	4	VIN (J)
2.4	2009.01	2011.12	129	175	-	4	-	-	-	JM5404	4	VIN (B)
2.5 24V	1995.01	2000.12	122	166	-	6		X	X	JM5305	1	Dist. T5T57172
2.7 V6	2008.01	2010.12	-	-	-	6		-	-	JM5375	6	VIN (R), VIN (D)
3.5 V6	2008.01	2010.12	-	-	-	6		-	-	JM5375	6	VIN (M), VIN (V)
<b>B100</b>												
7.2 V8 440cid	1974.01	1974.12	-	-	-	8		X	X	JM5613	1	
<b>B200</b>												
6.6 V8 400cid	1971.01	1971.12	-	-	-	8		X	X	JM5613	1	
6.6 V8 400cid	1974.01	1974.12	-	-	-	8		X	X	JM5613	1	
6.6 V8 400cid	1976.01	1978.12	-	-	-	8		X	X	JM5613	1	
7.2 V8 440cid	1974.01	1974.12	-	-	-	8		X	X	JM5613	1	
7.2 V8 440cid	1975.01	1978.12	-	-	-	8		X	X	JM5613	1	
<b>B300</b>												
6.6 V8 400cid	1976.01	1978.12	-	-	-	8		X	X	JM5613	1	
7.2 V8 440cid	1975.01	1978.12	-	-	-	8		X	X	JM5613	1	
<b>CALIBER</b>												
1.8	2006.09	2009.12	110	150	-	4	-	-	-	JM5404	4	VIN (C)



<b>DODGE USA</b>													
<b>CALIBER</b>													
2.0	2006.09	2011.12	118	160	-	4	-	-	-	-	JM5404	4	VIN (K), VIN (F), VIB (B)
2.0	2007.09	2008.12	110	148	-	4	-	-	-	-	JM5404	4	VIN (K), VIN (F)
2.4	2007.09	2010.12	213	285	-	4	-	-	-	-	JM5404	4	VIN (K), VIN (F), VIB (B)
2.4 AWD	2006.09	2007.12	128	174	-	4	-	-	-	-	JM5404	4	VIN (B)
<b>CARAVAN</b>													
2.4 DOHC 148 cid.	1996.01	1997.12	-	-	-	4		X	X		JM5071	1	VIN (B)
2.4 DOHC 148 cid.	1997.01	2007.12	-	-	-	4		X	X		JM5070	1	VIN (B)
3.3 V6 OHV 201 cid.	1991.01	1997.12	-	-	-	6		X	X		JM5072	1	VIN (J), VIN (R)
3.3 V6 CNG OHV 201 cid.	1995.01	-->	-	-	-	6		X	X		JM5072	1	VIN (J), VIN (R)
3.3	1999.01	2000.12	110	149	-	6		X	X		JM5388	1	VIN (G), VIN (R)
3.3	1999.01	2000.12	118	160	-	6		X	X		JM5388	1	VIN (G), VIN (R)
3.3	1999.01	2000.12	121	162	-	6		X	X		JM5388	1	VIN (G), VIN (R)
3.8	1999.01	1999.12	124	168	-	6	-/6	AM68	AMU68		JM5388	1	VIN (L)
3.8	1999.01	1999.12	130	176	-	6	-/6	AM68	AMU68		JM5388	1	VIN (L)
3.8 V6 OHV 230 cid.	1996.01	-->	-	-	-	6		X	X		JM5072	1	VIN (L)
<b>CB300</b>													
6.6 V8 400cid	1976.01	1978.12	-	-	-	8		X	X		JM5613	1	
7.2 V8 440cid	1977.01	1979.12	-	-	-	8		X	X		JM5613	1	
<b>CHALLENGER</b>													
3.5 V6	2009.01	2010.12	-	-	-	6		X	X		JM5375	6	VIN (V)
<b>CHARGER</b>													
2.7 24V	2006.01	2008.12	142	193	-	6	-	-	-	-	JM5375	6	VIN (R)
2.7 24V	2009.01	2010.12	142	193	-	6	-	-	-	-	JM5375	6	VIN (D)
3.5 24V	2006.01	2010.12	187	254	-	6	-	-	-	-	JM5375	6	VIN (G), VIN (V)
3.5 24V AWD	2006.01	2010.12	187	254	-	6	-	-	-	-	JM5375	6	VIN (G), VIN (V)
6.6	1971.09	1974.12	190	255	-	8	1/8	AM98	AMU98		X	-	
6.6 V8 400cid	1973.01	1978.12	-	-	-	8		X	X		JM5613	1	
7.2 V8 440cid	1973.01	1974.12	-	-	-	8		X	X		JM5613	1	
<b>COLT</b>													
1.5 12V	1993.01	1994.12	69	94	-	4		X	X		JM5198	1	
1.8	1991.09	1994.12	69	94	-	4		X	X		JM5197	1	Dist. D6034
1.8	1991.09	1994.12	84	113	-	4		X	X		JM5197	1	Dist. D6034
1.8 4x4	1991.09	1994.12	69	94	-	4		X	X		JM5197	1	Dist. D6034
1.8 AWD	1991.09	1992.12	69	94	-	4		X	X		JM5197	1	Dist. D6034
1.8 L4 MFI 112 cid	1992.01	1993.12	-	-	-	4		X	X		JM5198	1	
1.8 L4 MFI SOHC 112 cid	1992.01	1994.12	-	-	-	4		X	X		JM5197	1	
<b>CORONET</b>													
3.7	1974.09	1975.12	71	97	-	6	1/6	AM101	AMU101		X	-	
3.7	1974.09	1976.12	71	97	-	6	1/6	AM101	AMU101		X	-	
6.6	1971.09	1974.12	168	225	-	8	1/8	AM98	AMU98		X	-	
6.6 V8 400cid	1973.01	1976.12	-	-	-	8		X	X		JM5613	1	
6.6	1974.09	1976.12	123	165	-	8	1/8	AM98	AMU98		X	-	
6.6	1974.09	1976.12	141	192	-	8	1/8	AM98	AMU98		X	-	
7.2 V8 440cid	1973.01	1976.12	-	-	-	8		X	X		JM5613	1	
<b>D100</b>													
6.3 V8 363cid	1971.01	1971.12	-	-	-	8		X	X		JM5613	1	
6.6 V8 400cid	1971.01	1974.12	-	-	-	8		X	X		JM5613	1	
6.6 V8 400cid	1976.01	1978.12	-	-	-	8		X	X		JM5613	1	
7.2 V8 440cid	1973.01	1978.12	-	-	-	8		X	X		JM5613	1	
<b>D150</b>													
6.6 V8 400cid	1977.01	1978.12	-	-	-	8		X	X		JM5613	1	
<b>D200</b>													
6.3 V8 363cid	1971.01	1971.12	-	-	-	8		X	X		JM5613	1	
6.6 V8 400cid	1971.01	1978.12	-	-	-	8		X	X		JM5613	1	
7.2 V8 440cid	1973.01	1978.12	-	-	-	8		X	X		JM5613	1	
<b>D300</b>													
6.3 V8 363cid	1971.01	1971.12	-	-	-	8		X	X		JM5613	1	
6.6 V8 400cid	1971.01	1978.12	-	-	-	8		X	X		JM5613	1	
7.2 V8 440cid	1973.01	1978.12	-	-	-	8		X	X		JM5613	1	
<b>D400</b>													
7.2 V8 440cid	1978.01	1978.12	-	-	-	8		X	X		JM5613	1	
<b>D450</b>													
7.2 V8 440cid	1978.01	1978.12	-	-	-	8		X	X		JM5613	1	
<b>DAKOTA</b>													
3.7 V6 SOHC 226 cid.	2004.12	2007.12	-	-	-	6		-	-		JM5286	6	VIN (K)



DODGE USA												
<b>DAKOTA</b>												
4.7 V8 SOHC 285 cid.	2000.01	2007.12	-	-	-	8	-	-	JM5286	8	VIN (J), VIN (N)	
4.7 V8 FLEX 285 cid.	2007.01	2007.12	-	-	SOHC	8	-	-	JM5286	8	VIN (P)	
<b>DART</b>												
3.7	1974.09	1976.12	71	97	-	6	1/6	AM101	AMU101	X	-	
<b>DIPLOMAT</b>												
3.7	1977.09	1983.12	63	86	-	6	1/6	AM101	AMU101	X	-	
<b>DURANGO</b>												
5.7 4WD	2003.09	2005.12	254	345	HEMI	8	-/8	AM90	AMU90	JM5281	8 VIN (D); HEMI Eng.	
<b>DYNASTY</b>												
3.3 V6 OHV 201 cid.	1990.01	1993.12	-	-	-	6	-	X	X	JM5072	1 VIN (R)	
<b>GRAND CARAVAN</b>												
2.4 DOHC 148 cid.	1996.01	1997.12	-	-	-	4	-	X	X	JM5071	1 VIN (B)	
2.4 DOHC 148 cid.	1997.01	-->	-	-	-	4	-	X	X	JM5070	1 VIN (B)	
3.3 V6 OHV 201 cid.	1990.01	1998.12	-	-	-	6	-	X	X	JM5072	1 VIN (R)	
3.3 V6 CNG OHV 201 cid.	1996.01	-->	-	-	-	6	-	X	X	JM5072	1 VIN (J)	
3.3 V6 FLEX OHV 201 cid.	1998.01	-->	-	-	-	6	-	X	X	JM5072	1 VIN (G)	
3.3 Flexfuel	2000.09	2000.12	134	182	-	6	-/6	AM68	AMU68	JM5388	1 VIN (G) OE 4609140AB	
3.3 Flexfuel AWD	2000.09	2000.12	134	182	-	6	-/6	AM68	AMU68	JM5388	1 VIN (R); OE 4609140AB	
3.8 V6 OHV 230 cid.	1994.01	-->	-	-	-	6	-	X	X	JM5072	1 VIN (L)	
3.8	2000.09	2000.12	149	203	-	6	-/6	AM68	AMU68	JM5388	1 VIN (L); OE 4609140AB	
3.8 AWD	2000.09	2000.12	149	203	-	6	-/6	AM68	AMU68	JM5388	1 VIN (L); OE 4609140AB	
<b>INTREPID</b>												
3.3 V6 OHV 201 cid.	1990.01	1997.12	-	-	-	6	-	X	X	JM5072	1 VIN (T)	
3.3 V6 FLEX OHV 201 cid.	1993.01	-->	-	-	-	6	-	X	X	JM5072	1 VIN (U)	
3.5 V6 SOHC 215 cid.	1993.01	1997.12	-	-	-	6	-	X	X	JM5072	1 VIN (F)	
<b>JOURNEY</b>												
2.4	2008.09	2010.12	125	170	-	4	-	-	-	JM5404	4 VIN (B)	
2.4	2011.09	-->	129	173	-	4	-	X	X	JM5404	4	
3.5	2009.01	2010.12	-	-	-	6	-	-	-	JM5375	6 VIN (V)	
3.5 4x4	2009.01	2010.12	-	-	-	6	-	-	-	JM5375	6 VIN (V)	
<b>M300</b>												
7.2 V8 440cid	1974.01	1974.12	-	-	-	8	-	X	X	JM5613	1	
<b>M350</b>												
7.2 V8 440cid	1974.01	1974.12	-	-	-	8	-	X	X	JM5613	1	
<b>MAGNUM</b>												
2.7 24V	2006.01	2008.12	142	193	-	6	-	-	-	JM5375	6 VIN (T)	
3.5 24V	2006.01	2008.12	187	254	-	6	-	-	-	JM5375	6 VIN (V)	
3.5 24V AWD	2006.01	2008.12	187	254	-	6	-	-	-	JM5375	6 VIN (V)	
5.7	2004.09	2005.12	261	355	HEMI	8	-	X	X	JM5281	8 VIN (2); HEMI Eng.	
5.7 AWD	2004.09	2005.12	261	355	HEMI	8	-	X	X	JM5281	8 VIN (2); HEMI Eng.	
6.6 V8 400cid	1978.01	1978.12	-	-	-	8	-	X	X	JM5613	1	
<b>MONACO</b>												
3.7	1976.09	1978.12	84	114	-	6	1/6	AM101	AMU101	X	-	
3.7	1977.09	1978.12	75	102	-	6	1/6	AM101	AMU101	X	-	
3.7	1977.09	1978.12	84	114	-	6	1/6	AM101	AMU101	X	-	
6.6	1971.09	1974.12	131	178	-	8	1/8	AM98	AMU98	X	-	
6.6 V8 400cid	1973.01	1978.12	-	-	-	8	-	X	X	JM5613	1	
6.6	1974.09	1976.12	123	167	-	8	1/8	AM98	AMU98	X	-	
6.6	1974.09	1976.12	123	167	-	8	1/8	AM98	AMU98	X	-	
7.2 V8 440cid	1973.01	1978.12	-	-	-	8	-	X	X	JM5613	1	
<b>NEON</b>												
2.0 DOHC 122 cid.	1995.01	2001.12	-	-	-	4	-	X	X	JM5070	1 VIN (Y)	
2.0 DOHC 122 cid.	1995.01	1997.12	-	-	ECC	4	-	X	X	JM5070	1 VIN (Y)	
2.0 SOHC	1995.01	1996.12	-	-	ECB	4	-	X	X	JM5071	1 VIN (C)	
2.0 SOHC 122 cid.	2001.01	-->	-	-	-	4	-	X	X	JM5070	1 VIN (F)	
2.0 SOHC 122 cid.	2002.01	2005.12	-	-	-	4	-	X	X	JM5070	1 VIN (C)	
2.4 TURBO DOHC 148 cid.	2003.01	2005.12	-	-	-	4	-	X	X	JM5070	1 VIN (S)	
<b>NITRO</b>												
4.0	2007.01	2010.12	-	-	-	6	-	-	-	JM5375	6 VIN (6), VIN (X)	
4.0 4x4	2007.01	2010.12	-	-	-	6	-	-	-	JM5375	6 VIN (6), VIN (X)	
<b>POLARA</b>												
6.6 V8 400cid	1973.01	1973.01	-	-	-	8	-	X	X	JM5613	1	
7.2 V8 440cid	1973.01	1973.01	-	-	-	8	-	X	X	JM5613	1	



<b>DODGE USA</b>												
<b>RAM 1500</b>												
5.7	2002.09	2005.12	261	355	HEMI	8		X	X	JM5281	8	VIN (D)
5.7 4WD	2002.09	2005.12	261	355	HEMI	8		X	X	JM5281	8	VIN (D)
8.3 SRT-10	2004.09	2006.12	380	517	OHV	10		X	X	JM5070	1	VIN (H); 4 plug coil
8.3 SRT-10	2004.09	2006.12	380	517	OHV	10		X	X	JM5458	1	VIN (H); 6 plug coil
<b>RAM 2500</b>												
5.7	2003.09	2005.12	261	355	HEMI	8		X	X	JM5281	8	VIN (D)
5.7 4WD	2003.09	2005.12	261	355	HEMI	8		X	X	JM5281	8	VIN (D)
8.0	1997.01	2002.12	223	303	-	10		X	X	JM5070	1	VIN (W); 4 plug coil
8.0	1997.01	2002.12	223	303	-	10		X	X	JM5458	1	VIN (W); 6 plug coil
8.0	1997.01	2002.12	234	318	-	10		X	X	JM5070	1	VIN (W); 4 plug coil
8.0	1997.01	2002.12	234	318	-	10		X	X	JM5458	1	VIN (W); 6 plug coil
8.0 4WD	1997.01	2002.12	223	303	-	10		X	X	JM5070	1	VIN (W); 4 plug coil
8.0 4WD	1997.01	2002.12	223	303	-	10		X	X	JM5458	1	VIN (W); 6 plug coil
8.0 4WD	1997.01	2002.12	234	318	-	10		X	X	JM5070	1	VIN (W); 4 plug coil
8.0 4WD	1997.01	2002.12	234	318	-	10		X	X	JM5458	1	VIN (W); 6 plug coil
<b>RAM 3500</b>												
5.7	2003.09	2005.12	261	355	HEMI	8		X	X	JM5281	8	VIN (D)
5.7 4WD	2003.09	2005.12	261	355	HEMI	8		X	X	JM5281	8	VIN (D)
8.0	1997.01	2003.12	223	303	-	10		X	X	JM5070	1	VIN (W); 4 plug coil
8.0	1997.01	2003.12	223	303	-	10		X	X	JM5458	1	VIN (W); 6 plug coil
8.0	1997.01	2003.12	234	318	-	10		X	X	JM5070	1	VIN (W); 4 plug coil
8.0	1997.01	2003.12	234	318	-	10		X	X	JM5458	1	VIN (W); 6 plug coil
8.0 4WD	1997.01	2003.12	223	303	-	10		X	X	JM5070	1	VIN (W); 4 plug coil
8.0 4WD	1997.01	2003.12	223	303	-	10		X	X	JM5458	1	VIN (W); 6 plug coil
8.0 4WD	1997.01	2003.12	234	318	-	10		X	X	JM5070	1	VIN (W); 4 plug coil
8.0 4WD	1997.01	2003.12	234	318	-	10		X	X	JM5458	1	VIN (W); 6 plug coil
<b>RAMCHARGER</b>												
6.6 V8 400cid	1974.01	1978.12	-	-	-	8		X	X	JM5613	1	
7.2 V8 440cid	1974.01	1978.12	-	-	-	8		X	X	JM5613	1	
<b>ROYAL MONACO</b>												
6.6 V8 400cid	1975.01	1977.12	-	-	-	8		X	X	JM5613	1	
7.2 V8 440cid	1975.01	1977.12	-	-	-	8		X	X	JM5613	1	
<b>STEALTH HACHBACK</b>												
3.0 24V	1991.01	1992.12	122	166	-	6		X	X	JM5327	3	VIN (B), VIN (C)
3.0 24V TURBO AWD	1991.01	1992.12	224	305	-	6		X	X	JM5327	3	VIN (B), VIN (C)
3.0 24V	1993.01	1996.12	122	166	-	6		X	X	JM5327	3	VIN (J), VIN (K)
3.0 24V TURBO AWD	1993.01	1996.12	224	305	-	6		X	X	JM5327	3	VIN (J), VIN (K)
<b>STRATUS</b>												
2.0 SOHC 122 cid.	1995.01	1996.12	-	-	ECB	4		X	X	JM5071	1	VIN (C)
2.4 DOHC 148 cid.	1995.01	1996.12	-	-	EDZ	4		X	X	JM5071	1	VIN (X)
2.4 DOHC 148 cid.	1997.01	-->	-	-	EDZ	4		X	X	JM5070	1	VIN (X)
2.4 SOHC	2001.01	2005.12	-	-	-	4	-/2	JP200	-	JM5121	2	JM1185 or JM1194 VIN (G)
2.4 DOHC 148 cid.	2004.01	2005.12	-	-	-	4		X	X	JM5070	1	VIN (J)
2.5 24V	1995.01	2000.12	125	170	-	6		X	X	JM5305	1	Dist. T5T57172
2.7 24V	2006.01	2006.12	149	203	-	6	-	-	-	JM5375	6	VIN (R), VIN (T)
2.7 24V FLEX	2006.01	2006.12	149	203	-	6	-	-	-	JM5375	6	VIN (R), VIN (T)
3.0	2000.09	2005.12	149	103	-	6		X	X	JM5316	1	Dist. T0T58171A U=12[V]
3.0	2000.09	2005.12	149	103	-	6		X	X	JM5317	1	Dist. T0T58171U=14[V]
<b>TALON</b>												
2.0 DOHC 122 cid.	1996.01	1998.12	-	-	ECF	4		X	X	JM5070	1	VIN (Y)
<b>VIPER</b>												
8.0	1997.01	2002.12	299	407	-	10		X	X	JM5070	1	VIN (E); 4 plug coil
8.0	1997.01	2002.12	299	407	-	10		X	X	JM5458	1	VIN (E); 6 plug coil
8.0	1997.01	2002.12	310	422	-	10		X	X	JM5070	1	VIN (E); 4 plug coil
8.0	1997.01	2002.12	310	422	-	10		X	X	JM5458	1	VIN (E); 6 plug coil
8.3 SRT-10	1995.09	2002.12	310	422	-	10		X	X	JM5070	1	VIN (E); 4 plug coil
8.3 SRT-10	1995.09	2002.12	310	422	-	10		X	X	JM5458	1	VIN (E); 6 plug coil
8.3 SRT-10	1995.09	2006.12	310	422	-	10		X	X	JM5070	1	VIN (Z); 4 plug coil
8.3 SRT-10	1995.09	2006.12	310	422	-	10		X	X	JM5458	1	VIN (Z); 6 plug coil
<b>W100</b>												
6.3 V8 363cid	1971.01	1971.01	-	-	-	8		X	X	JM5613	1	
6.6 V8 400cid	1971.01	1971.01	-	-	-	8		X	X	JM5613	1	
6.6 V8 400cid	1974.01	1977.12	-	-	-	8		X	X	JM5613	1	
7.2 V8 440cid	1974.01	1977.12	-	-	-	8		X	X	JM5613	1	



**DODGE USA**

<b>W150</b>											
6.6 V8 400cid	1977.01	1978.12	-	-	-	8		X	X	JM5613	1
7.2 V8 440cid	1978.01	1978.12	-	-	-	8		X	X	JM5613	1
<b>W200</b>											
6.3 V8 363cid	1971.01	1971.01	-	-	-	8		X	X	JM5613	1
6.6 V8 400cid	1971.01	1971.01	-	-	-	8		X	X	JM5613	1
6.6 V8 400cid	1974.01	1974.12	-	-	-	8		X	X	JM5613	1
6.6 V8 400cid	1976.01	1978.12	-	-	-	8		X	X	JM5613	1
7.2 V8 440cid	1974.01	1978.12	-	-	-	8		X	X	JM5613	1
<b>W300</b>											
6.3 V8 363cid	1971.01	1971.01	-	-	-	8		X	X	JM5613	1
6.6 V8 400cid	1976.01	1978.12	-	-	-	8		X	X	JM5613	1
7.2 V8 440cid	1975.01	1978.12	-	-	-	8		X	X	JM5613	1

**EAGLE**

<b>TALON</b>											
2.0 TSi Turbo	1994.05	1998.09	157	213	-	4		X	X	JM5071	1
2.0 TSi Turbo 4x4	1994.05	1998.09	157	213	-	4		X	X	JM5071	1
<b>VISION</b>											
3.3	1992.08	1996.09	120	163	EGB	6	-/6	X	X	JM5072	1
3.5	1992.08	1996.09	160	218	-	6	-/6	AM10	AMU10	JM5072	1

**EAGLE USA**

<b>SUMMIT</b>											
1.5	1991.01	1996.12	68	92	-	4		X	X	JM5198	1
1.5	1992.01	1996.12	60	82	-	4		X	X	JM5198	1
1.8	1991.09	1996.12	84	115	-	4		X	X	JM5197	1 Dist. D6034
1.8 4WD	1991.09	1993.12	84	115	-	4		X	X	JM5197	1 Dist. D6034
<b>TALON</b>											
1.8 L4 MFI SOHC 107 cid	1992.09	1994.12	68	92	-	4		X	X	JM5198	1
2.0	1991.01	1994.12	100	136	-	4	-/4	JP107	JPE107	JM5326	2
2.0	1995.01	1996.12	100	136	ECF	4		X	X	JM5071	1 VIN (Y)
2.0	1995.01	1998.12	100	136	-	4		X	X	JM5070	1 VIN (Y)
2.0 Turbocharged	1995.01	1996.12	157	213	-	4		X	X	JM5327	2 VIN (F)
<b>VISION</b>											
3.3 V6 FLEX OHV	1992.08	1996.09	120	163	-	6		X	X	JM5072	1 VIN (T)
3.5 V6 SOHC	1993.01	1997.12	160	217	-	6		AM10	AMU10	JM5072	1 VIN (F)

**FIAT USA**

<b>124</b>											
1.2	1966.09	1969.12	49	66	-	4		X	X	JM5210	1 Internal resistor
1.2	1966.09	1969.12	49	66	-	4		X	X	JM5355	1 External resistor
1.4	1967.09	1973.12	49	66	-	4		X	X	JM5210	1 Internal resistor
1.4	1967.09	1973.12	49	66	-	4		X	X	JM5355	1 External resistor
1.6	1970.09	1973.12	51	68	-	4		X	X	JM5210	1 Internal resistor
1.6	1970.09	1973.12	51	68	-	4		X	X	JM5355	1 External resistor
1.6	1973.09	1974.12	58	78	-	4		X	X	JM5210	1 Internal resistor
1.6	1973.09	1974.12	58	78	-	4		X	X	JM5355	1 External resistor
1.8	1974.09	1975.12	87	118	-	4		X	X	JM5210	1 Internal resistor
1.8	1974.09	1975.12	87	118	-	4		X	X	JM5355	1 External resistor
1.8	1974.09	1978.12	94	128	-	4		X	X	JM5210	1 Internal resistor
1.8	1974.09	1978.12	94	128	-	4		X	X	JM5355	1 External resistor
2.0	1978.09	1981.12	63	86	-	4		X	X	JM5355	1
2.0	1981.09	1983.12	76	102	-	4		X	X	JM5355	1
<b>128</b>											
1.3	1974.09	1977.12	53	73	-	4		X	X	JM5210	1 Internal resistor
1.3	1974.09	1977.12	53	73	-	4		X	X	JM5355	1 External resistor
1.3	1978.01	1979.12	55	75	-	4		X	X	JM5355	1
<b>850</b>											
0.8	1966.09	1973.12	31	42	-	4		X	X	JM5455	1 + resistor
0.8	1970.01	1973.12	31	42	-	4		X	X	JM5210	1 Internal resistor
0.8	1970.01	1973.12	31	42	-	4		X	X	JM5355	1 External resistor
0.9	1966.09	1967.12	31	42	-	4		X	X	JM5455	1 + resistor
0.9	1970.01	1973.12	31	42	-	4		X	X	JM5455	1 + resistor
0.9	1970.01	1973.12	31	42	-	4		X	X	JM5210	1 Internal resistor
0.9	1970.01	1973.12	31	42	-	4		X	X	JM5355	1 External resistor



## FIAT USA

BRAVA												
2.0	1981.01	1981.12	60	81	-	4		X	X	JM5355	1	01.1981 - 12.1981
STILO												
2.4	2006.09	2007.12	125	170	-	5	-	-	-	JM5031	5	
STRADA												
1.5	1978.09	1982.12	51	69	-	4		X	X	JM5355	1	VIN (A)
1.5	1978.09	1982.12	63	85	-	4		X	X	JM5355	1	VIN (A)
X-1/9												
1.3	1974.09	1983.12	46	63	-	4		X	X	JM5210	1	Internal resistor
1.3	1974.09	1983.12	46	63	-	4		X	X	JM5355	1	External resistor
1.5	1980.01	1983.12	50	68	-	4		X	X	JM5355	1	VIN (A)
1.5	1980.01	1983.12	62	85	-	4		X	X	JM5355	1	VIN (A)
2.0	1982.09	1983.12	55	76	-	4		X	X	JM5355	1	VIN (B)

## FORD AUS

FAIRLANE												
4.0 MPFi	2003.07	2005.09	182	248	-	6	-	-	-	JM5087	6	
4.0 MPFi	2005.10	2007.12	190	258	-	6	-	-	-	JM5087	6	
FALCON												
4.0	2002.09	-->	182	248	BARRA182	6	-	-	-	JM5087	6	
4.0 LPG	2002.09	2005.09	156	212	-	6	-	-	-	JM5087	6	
4.0 iXR6	2002.09	2005.09	182	248	-	6	-	-	-	JM5087	6	
4.0 iXR6 Turbo	2002.09	2005.09	240	326	-	6	-	-	-	JM5087	6	
4.0 i	2002.10	2005.09	182	248	-	6	-	-	-	JM5087	6	
4.0	2005.10	2008.04	156	212	-	6	-	-	-	JM5087	6	
4.0 iXR6	2005.10	2008.04	190	258	-	6	-	-	-	JM5087	6	
4.0 iXR6 Turbo	2005.10	2008.04	245	333	-	6	-	-	-	JM5087	6	
4.0 LPG	2005.10	-->	156	212	-	6	-	-	-	JM5087	6	
5.4 i V8 XR8	2003.01	2008.04	260	354	Boss 260	8	-	-	-	JM5088	8	JM1193
5.4 i V8	2008.02	-->	290	394	Boss 290	8	-	-	-	JM5088	8	JM1193
LASER												
1.8 i	1994.10	1999.03	92	125	-	4		X	X	JM5307	1	Dist. T2T57971, FB1318200A
LTD												
4.1 Efi	1984.10	1986.01	120	163	-	6		X	X	JM5336	1	
4.1 Efi	1986.02	1986.10	121	165	-	6		X	X	JM5336	1	
MUSTANG coupe												
4.6 V8	1999.06	2003.09	236	321	-	8	-	-	-	JM5088	8	JM1193
PROBE												
2.5	1994.07	1998.01	120	163	-	6		X	X	JM5304	1	Dist. T0T57071
TELESTAR												
2.0	1992.01	1994.08	85	116	FS	4		X	X	JM5300	1	Dist. type S5
2.0	1992.01	1994.08	85	116	FS	4		X	X	JM5318	1	Dist. type S9
2.0 EFi	1994.10	1996.11	85	116	-	4		X	X	JM5307	1	Dist. T2T57971, FB1318200A
2.0	1994.01	1996.12	-	-	FS	4		X	X	JM5318	1	Dist. FS90-18-200 Dist. Type S9
2.5	1992.01	1994.08	120	163	-	6		X	X	JM5304	1	Dist. T0T57071
2.5	1992.01	1994.08	123	167	-	6		X	X	JM5304	1	Dist. T0T57071
TERRITORY												
4.0	2004.05	2011.05	182	248	-	6	-	-	-	JM5087	6	
4.0 AWD	2004.05	2011.05	190	258	-	6	-	-	-	JM5087	6	
4.0 Turbo AWD	2006.07	2011.05	245	333	-	6	-	-	-	JM5087	6	

## FORD OTOSAN

ANADOL												
1.3	1967.01	1982.12	40	54	KL13	4	1/4	FS1	FU1	X	1	

## FORD USA

AEROSTAR												
2.3	1986.01	1987.12	-	-	-	4	1/4	AM2	AMU2	X	-	
2.3	1986.01	1987.12	-	-	140cid	4		X	X	JM5365	1	VIN (A)
2.3 8V	1986.01	1987.12	66	90	-	4		X	X	JM5365	1	VIN (A)
2.8	1985.01	-->	-	-	-	6	1/6	AM6	AMU6	X	-	
2.8 12V	1986.01	1986.12	86	117	-	6		X	X	JM5365	1	VIN (S)
2.8 V6	1986.01	1986.12	-	-	171cid	6		X	X	JM5365	1	VIN (S)
3.0 12V	1986.01	1997.12	101	137	-	6		X	X	JM5365	1	VIN (U)
3.0 i V6	1986.03	1997.12	108	147	-	6	1/6	AM6	AMU6	JM5365	1	VIN (U)



FORD USA												
<b>AEROSTAR</b>												
3.0	1990.01	-->	-	-	-	6	-/6	AM7	AMU7	X	-	
4.0 i V6 4WD	1989.09	1997.12	115	156	-	6	1/6	AM6	AMU6	JM5074	1	OE F82U-12029-AA
<b>ANGLIA</b>												
1.0	1963.01	1964.12	-	-	-	4		X	X	JM5455	1	+ resistor
1.2	1964.01	1967.12	-	-	-	4		X	X	JM5455	1	+ resistor
<b>BRONCO</b>												
2.9 i V6 4x4	1988.01	1990.08	104	141	-	6	1/6	AM38	AMU38	X	-	
<b>CLUB</b>												
5.4 wagon autobus	1996.09	1998.12	190	258	-	8	-	-	-	JM5076	8	JM1190
5.8 sedan	1957.09	1964.12	-	-	-	8	1/8	AM96	AMU96	X	-	
<b>CONSUL</b>												
1.3	1962.01	1963.12	-	-	-	4		X	X	JM5455	1	+ resistor
<b>CONTOUR</b>												
2.5	1997.09	1998.12	125	170	-	6		X	X	JM5073	1	VIN (L), VIN (G)
<b>COUNTRY</b>												
5.8	1968.09	1974.12	114	155	-	8	1/8	AM96	AMU96	X	-	
<b>COUNTRY SQUIRE</b>												
5.0	1986.09	1991.12	112	152	-	8	1/8	AM91	AMU91	X	-	
5.0 V8	1988.01	1990.12	-	-	-	8	2/8	AM39	AMU39	X	-	
5.8	1968.09	1974.12	114	155	-	8	1/8	AM96	AMU96	X	-	
<b>COURIER</b>												
1.8	1977.01	1979.12	50	68	-	4		X	X	JM5355	1	VIN (A), VIN (C)
2.0	1978.09	1982.12	54	73	-	4		X	X	JM5355	1	VIN (C), VIN (1)
2.0 AWD	1978.09	1982.12	54	73	-	4		X	X	JM5355	1	VIN (C), VIN (1)
2.0	1978.09	1979.12	69	92	-	4		X	X	JM5355	1	VIN (C)
2.3	1976.09	1982.12	50	67	-	4		X	X	JM5355	1	VIN (B), VIN (2)
2.3	1976.09	1982.12	54	72	-	4		X	X	JM5355	1	VIN (B), VIN (2)
<b>CROWN VICTORIA</b>												
4.6	1991.09	1998.04	142	193	-	8	-/8	AM52	AMU52	X	-	
4.6 LX Supercharged	1991.09	1998.04	157	213	-	8	-/8	AM52	AMU52	X	-	
4.6	1997.09	2006.12	133	178	-	8	-	-	-	JM5076	8	
4.6 Flexfuel	2005.09	2007.12	167	227	-	8	-	-	-	JM5076	8	JM1190 VIN (9), VIN (W)
4.6	2007.09	2008.12	167	224	-	8	-	-	-	JM5076	8	
4.6 FLEX	2008.09	2011.12	187	250	-	8	-	-	-	JM5076	8	JM1190; VIN (V)
5.0	1986.09	1991.12	112	152	-	8	1/8	AM91	AMU91	X	-	
5.0 V8	1989.01	1991.12	-	-	-	8	2/8	AM39	AMU39	X	-	
<b>CROWN VICTORIA LX, LX SPORT, POLICE INTERCEPTOR</b>												
4.6 V8 SOHC	1998.01	2009.12	-	-	-	8	-	-	-	JM5076	8	JM1190; VIN (W)
4.6 V8 SOHC FLEX	2006.01	-->	-	-	-	8	-	-	-	JM5076	8	JM1190; VIN (V)
<b>CROWN VICTORIA S</b>												
4.6 V8 SOHC	1998.01	-->	-	-	-	8	-	-	-	JM5076	8	JM1190; VIN (W)
<b>CUSTOM, CUSTOM 500</b>												
5.8	1968.09	1972.12	114	155	-	8	1/8	AM96	AMU96	X	-	
5.8	1968.09	1974.12	114	155	-	8	1/8	AM96	AMU96	X	-	
<b>E series</b>												
4.2	2001.10	2007.09	140	190	-	6		X	X	JM5075	1	
<b>E SUPER DUTY</b>												
5.4 V8 SOHC	1997.01	2002.12	-	-	-	8	-	-	-	JM5076	8	JM1190; VIN (L)
5.4 V8 SOHC CNG	2001.01	2002.12	-	-	-	8	-	-	-	JM5076	8	JM1190; VIN (M)
6.8 V10 SOHC	1997.01	2002.12	-	-	-	10	-	-	-	JM5076	10	JM1190; VIN (S)
<b>E-150</b>												
4.6	2002.09	2006.12	168	228	-	8	-	-	-	JM5076	8	JM1190; VIN (W)
4.6 V8 SOHC	2006.01	2008.12	-	-	-	8	-	-	-	JM5076	8	JM1190; VIN (W)
4.6 V8 SOHC FLEX	2009.01	-->	-	-	-	8	-	-	-	JM5076	8	JM1190; VIN (W)
5.4	2002.09	2005.12	190	258	-	8	-	-	-	JM5076	8	JM1190; VIN (L)
5.4 V8 SOHC	2006.01	2008.12	-	-	-	8	-	-	-	JM5076	8	JM1190; VIN (L)
5.4 V8 SOHC FLEX	2009.01	-->	-	-	-	8	-	-	-	JM5076	8	JM1190; VIN (L)
<b>E-150 CHATEAU</b>												
4.6 V8 SOHC	2006.01	2007.12	-	-	-	8	-	-	-	JM5076	8	JM1190 VIN (L), VIN (W)
<b>E-150 CLUB ECONOLINE, ECONOLINE CLUB WAGON</b>												
4.2 12V	1997.01	2002.12	151	205	-	6		X	X	JM5075	1	
4.2 V6 256cid	1998.01	2000.12	-	-	-	6		X	X	JM5073	1	VIN (2)
4.6 V8 SOHC 281cid	2000.01	2002.12	-	-	-	8	-	-	-	JM5076	8	JM1190; VIN (W)
5.4 V8 SOHC	1997.01	2005.12	-	-	-	8	-	-	-	JM5076	8	JM1190; VIN (L)



## FORD USA

E-150 CLUB ECONOLINE, ECONOLINE CLUB WAGON													
5.4 V8 SOHC Bi-Fuel	1998.01	-->	-	-	-	8	-	-	-	-	JM5076	8	JM1190; VIN (Z)
5.4 V8 SOHC 330cid	2007.01	2008.12	-	-	-	8	-	-	-	-	JM5076	8	JM1190
E-150 CLUB WAGON													
4.6 V8 SOHC 281cid	2003.01	2006.12	-	-	-	8	-	-	-	-	JM5076	8	JM1190
5.4 V8 SOHC 330cid	2003.01	2006.12	-	-	-	8	-	-	-	-	JM5076	8	JM1190
E-150 EXTENDED CARGO VAN													
4.6 FLEX	2010.09	-->	168	225	-	8	-	-	-	-	JM5076	8	JM1190
5.4 CNG	2010.09	-->	190	255	-	8	-	-	-	-	JM5076	8	JM1190
5.4 FLEX	2010.09	-->	190	255	-	8	-	-	-	-	JM5076	8	JM1190
5.4 LPG	2010.09	-->	190	255	-	8	-	-	-	-	JM5076	8	JM1190
E-150 STANDARD CARGO VAN													
4.6	2006.09	2008.12	168	225	-	8	-	-	-	-	JM5076	8	JM1190; VIN (W)
4.6 Flexfuel	2008.09	2010.12	168	225	-	8	-	-	-	-	JM5076	8	JM1190; VIN (W)
4.6 CNG	2009.09	2010.12	168	225	-	8	-	-	-	-	JM5076	8	JM1190; VIN (W)
4.6 LPG	2009.09	2010.12	168	225	-	8	-	-	-	-	JM5076	8	JM1190; VIN (W)
5.4	2006.09	2008.12	190	255	-	8	-	-	-	-	JM5076	8	JM1190; VIN (L)
5.4 Flexfuel	2008.09	2010.12	190	255	-	8	-	-	-	-	JM5076	8	JM1190; VIN (L)
5.4 CNG	2009.09	2010.12	190	255	-	8	-	-	-	-	JM5076	8	JM1190; VIN (L)
5.4 LPG	2009.09	2010.12	190	255	-	8	-	-	-	-	JM5076	8	JM1190; VIN (L)
5.8	1974.09	1975.12	122	163	-	8	1/8	AM96	AMU96	X	-	-	-
5.8	1975.09	1976.12	133	178	-	8	1/8	AM96	AMU96	X	-	-	-
E-150 STANDARD PASSENGER VAN													
4.6	2006.09	2008.12	168	225	-	8	-	-	-	-	JM5076	8	JM1190; VIN (W)
4.6 Flexfuel	2008.09	2010.12	168	225	-	8	-	-	-	-	JM5076	8	JM1190; VIN (W)
5.4	2006.09	2008.12	190	255	-	8	-	-	-	-	JM5076	8	JM1190; VIN (L)
5.4 Flexfuel	2008.09	2010.12	190	255	-	8	-	-	-	-	JM5076	8	JM1190; VIN (L)
5.4 CNG	2009.09	2010.12	190	255	-	8	-	-	-	-	JM5076	8	JM1190; VIN (L)
5.4 LPG	2009.09	2010.12	190	255	-	8	-	-	-	-	JM5076	8	JM1190; VIN (L)
E-150 XL, XLT													
4.6 V8 SOHC	2006.01	2008.12	-	-	-	8	-	-	-	-	JM5076	8	JM1190; VIN (W)
4.6 V8 SOHC FLEX	2009.01	-->	-	-	-	8	-	-	-	-	JM5076	8	JM1190; VIN (W)
5.4 V8 SOHC	2006.01	2008.12	-	-	-	8	-	-	-	-	JM5076	8	JM1190; VIN (L)
5.4 V8 SOHC Bi-Fuel	2009.01	-->	-	-	-	8	-	-	-	-	JM5076	8	JM1190; VIN (L)
E-250													
4.6	2006.09	2008.12	168	225	-	8	-	-	-	-	JM5076	8	JM1190; VIN (W)
4.6 Flexfuel	2008.09	2010.12	168	225	-	8	-	-	-	-	JM5076	8	JM1190; VIN (W)
4.6 V8 SOHC FLEX	2009.01	-->	-	-	-	8	-	-	-	-	JM5076	8	JM1190; VIN (W)
5.4	2002.09	2003.12	190	258	-	8	-	-	-	-	JM5076	8	JM1190 VIN (L), VIN (M)
5.4 CNG	2002.09	2003.12	190	258	-	8	-	-	-	-	JM5076	8	JM1190 VIN (L), VIN (M)
5.4 V8 SOHC	2006.01	2008.12	-	-	-	8	-	-	-	-	JM5076	8	JM1190; VIN (L)
5.4 Flexfuel	2008.09	2010.12	190	255	-	8	-	-	-	-	JM5076	8	JM1190; VIN (L)
5.4 V8 SOHC Bi-Fuel	2009.01	-->	-	-	-	8	-	-	-	-	JM5076	8	JM1190; VIN (L)
5.4 LPG	2009.09	2010.12	190	255	-	8	-	-	-	-	JM5076	8	JM1190; VIN (L)
E-250 CUTAWAY													
4.6 FLEX	2010.09	-->	168	228	-	8	-	-	-	-	JM5076	8	JM1190
5.4 CNG	2010.09	-->	190	255	-	8	-	-	-	-	JM5076	8	JM1190
5.4 FLEX	2010.09	-->	190	255	-	8	-	-	-	-	JM5076	8	JM1190
5.5 LPG	2010.09	-->	190	255	-	8	-	-	-	-	JM5076	8	JM1190
E-250 ECONOLINE, ECONOLINE SUPER													
4.2 12V	1997.01	2002.12	151	205	-	6	-	X	X	-	JM5075	1	-
4.2 V6 256cid	1998.01	2000.12	-	-	-	6	-	X	X	-	JM5073	1	-
5.4 V8 SOHC	1997.01	2005.12	-	-	-	8	-	-	-	-	JM5076	8	JM1190; VIN (L)
5.4 V8 SOHC CNG	1997.01	2005.12	-	-	-	8	-	-	-	-	JM5076	8	JM1190; VIN (M)
5.4 V8 SOHC Bi-Fuel	1998.01	1999.12	-	-	-	8	-	-	-	-	JM5076	8	JM1190; VIN (Z)
6.8 V10 SOHC	1997.01	2005.12	-	-	-	10	-	-	-	-	JM5076	10	JM1190; VIN (S)
E-250 EXTENDED CARGO VAN													
4.6 Flexfuel	2008.09	2010.12	168	225	-	8	-	-	-	-	JM5076	8	JM1190; VIN (W)
5.4	2002.09	2005.12	190	258	-	8	-	-	-	-	JM5076	8	JM1190; VIN (M), VIN (L)
5.4 CNG	2002.09	2005.12	190	258	-	8	-	-	-	-	JM5076	8	JM1190; VIN (M)
5.4 Flexfuel	2008.09	2010.12	190	255	-	8	-	-	-	-	JM5076	8	JM1190; VIN (L)
5.4 LPG	2009.09	2010.12	190	255	-	8	-	-	-	-	JM5076	8	JM1190; VIN (L)
E-250 STANDARD CARGO VAN													
4.6 FLEX	2010.09	-->	168	225	-	8	-	-	-	-	JM5076	8	JM1190





													<b>FORD USA</b>
<b>E-250 STANDARD CARGO VAN</b>													
5.4 CNG	2010.09	-->	190	255	-		8	-	-	-	JM5076	8	JM1190
5.4 FLEX	2010.09	-->	190	255	-		8	-	-	-	JM5076	8	JM1190
5.5 LPG	2010.09	-->	190	255	-		8	-	-	-	JM5076	8	JM1190
<b>E-250 SUPER DUTY</b>													
5.4	2003.09	2005.12	190	258	-		8	-	-	-	JM5076	8	JM1190
5.4 CNG	2003.09	2005.12	190	258	-		8	-	-	-	JM5076	8	JM1190
<b>E-350 ECONOLINE</b>													
5.4 V8 SOHC	1997.01	2005.12	-	-	-		8	-	-	-	JM5076	8	JM1190; VIN (L)
5.4 V8 SOHC CNG	1997.01	2005.12	-	-	-		8	-	-	-	JM5076	8	JM1190; VIN (M)
5.4 V8 SOHC Bi-Fuel	1998.01	1999.12	-	-	-		8	-	-	-	JM5076	8	JM1190; VIN (Z)
6.8 V10 SOHC	1997.01	2005.12	-	-	-		10	-	-	-	JM5076	10	JM1190; VIN (S)
<b>E-350 ECONOLINE HD CLUB WAGON</b>													
5.4 V8 SOHC	1997.01	1998.12	-	-	-		8	-	-	-	JM5076	8	JM1190; VIN (L)
6.8 V10 SOHC	1997.01	2005.12	-	-	-		10	-	-	-	JM5076	10	JM1190; VIN (S)
<b>E-350 ECONOLINE SUPER, SUPER WAGON</b>													
5.4 V8 SOHC	1997.01	1999.12	-	-	-		8	-	-	-	JM5076	8	JM1190; VIN (L)
5.4 V8 SOHC CNG	1997.01	1998.12	-	-	-		8	-	-	-	JM5076	8	JM1190; VIN (M)
5.4 V8 SOHC Bi-Fuel	1998.01	-->	-	-	-		8	-	-	-	JM5076	8	JM1190; VIN (Z)
6.8 V10 SOHC	1997.01	1998.12	-	-	-		10	-	-	-	JM5076	10	JM1190; VIN (S)
<b>E-350 ECONOLINE SUPER DUTY, SUPER DUTY XL, XLT</b>													
5.4 V8 SOHC	2006.12	2008.12	-	-	-		8	-	-	-	JM5076	8	JM1190; VIN (L)
5.4 V8 SOHC FLEX	2006.12	-->	-	-	-		8	-	-	-	JM5076	8	JM1190; VIN (L)
6.8 V10 SOHC	2006.12	2009.12	-	-	-		10	-	-	-	JM5076	10	JM1190; VIN (S)
<b>E-450 ECONOLINE</b>													
5.4 V8 SOHC	2003.01	2005.12	-	-	-		8	-	-	-	JM5076	8	JM1190; VIN (L)
6.8 V10 SOHC	2003.01	2005.12	-	-	-		10	-	-	-	JM5076	10	JM1190; VIN (S)
<b>E-450 ECONOLINE SUPER DUTY</b>													
5.4 V8 SOHC	2006.01	2008.12	-	-	-		8	-	-	-	JM5076	8	JM1190; VIN (L)
5.4 V8 SOHC FLEX	2009.01	-->	-	-	-		8	-	-	-	JM5076	8	JM1190; VIN (L)
6.8 V10 SOHC	2006.01	2008.12	-	-	-		10	-	-	-	JM5076	10	JM1190; VIN (S)
<b>E-550 ECONOLINE SUPER DUTY CUSTOM</b>													
6.8 V10 SOHC	2003.01	-->	-	-	-		10	-	-	-	JM5076	10	JM1190; VIN (S)
<b>ECONOLINE</b>													
4.2	2003.01	2003.12					6		X	X	JM5075	1	
5.4	1998.09	2001.12	190	258	-		8	-	-	-	JM5076	8	JM1190; VIN (L), VIN (M), VIN (Z)
5.4	2001.09	2002.12	194	260	-		8	-	-	-	JM5076	8	JM1190; VIN (L), VIN (M)
<b>EDGE</b>													
3.5	2006.09	2011.12	197	269	-		6	-	-	-	JM5498	6	VIN (C)
3.5 AWD	2006.09	2011.12	197	269	-		6	-	-	-	JM5498	6	VIN (C)
3.5	2011.09	-->	213	290	-		6		X	X	JM5498	6	VIN (K)
3.5 AWD	2011.09	-->	213	290	-		6		X	X	JM5498	6	VIN (K)
<b>ELITE</b>													
5.8	1974.09	1976.12	107	146	-		8	1/8	AM96	AMU96	X	-	
<b>ESCAPE</b>													
2.3 16V	2005.01	2007.12	114	155	-		4	-	-	-	JM5059	4	VIN (H), VIN (Z)
2.3 16V AWD	2005.01	2007.12	114	155	-		4	-	-	-	JM5059	4	VIN (H), VIN (Z)
2.3 16V ELECTRIC/GAS	2005.01	2007.12	114	155	-		4	-	-	-	JM5059	4	VIN (H), VIN (Z)
2.3 DOHC	2005.01	2008.12	-	-	-		4		X	X	JM5059	4	VIN (Z)
2.3 DOHC ELECTRIC/GAS	2005.01	2008.12	-	-	-		4		X	X	JM5059	4	VIN (H)
2.5	2008.09	2012.12	132	177	-		4	-	-	-	JM5617	4	VIN (3), VIN (7) GREY ign.coil boots
2.5 Hybrid 4WD	2008.09	2012.12	132	177	-		4	-	-	-	JM5617	4	VIN (3), VIN (7) GREY ign.coil boots
3.0 24V	2001.01	2007.12	149	203	182cid		6	-	-	-	JM5340	6	VIN (1)
3.0 24V AWD	2001.01	2005.12	149	203	182cid		6	-	-	-	JM5340	6	VIN (1)
3.0 4x4	2001.01	2004.04	145	197	-		6	-	-	-	JM5340	6	VIN (1)
3.0 4x4	2004.05	2007.07	152	207	-		6	-	-	-	JM5340	6	VIN (1)
3.0 24V	2006.01	2007.12	149	203	183cid		6	-	-	-	JM5340	6	VIN (1)
3.0 24V AWD	2006.01	2006.12	149	203	183cid		6	-	-	-	JM5340	6	VIN (1)
3.0 24V AWD	2007.01	2007.12	149	203	183cid		6	-	-	-	JM5600	6	VIN (1)
3.0	2007.09	2010.12	150	204	-		6		X	X	JM5600	6	VIN (1), VIN (G)
3.0 4WD	2007.09	2009.12	150	204	-		6		X	X	JM5600	6	VIN (1), VIN (G)
3.0 FLEX	2009.09	-->	179	243	99G		6		X	X	JM5600	6	VIN (G)
3.0 FLEX 4WD	2009.09	-->	179	243	99G		6		X	X	JM5600	6	VIN (G)



## FORD USA

ESCORT												
1.8	1990.04	1996.05	94	128	-	4	1/4	AM1	AMU1	JM5337	1	
1.8 LX-E	1991.09	1996.05	94	128	-	4	1/4	AM1	AMU1	X	-	
1.9 GL	1985.05	1988.04	64	87	-	4	1/4	AM5	AMU5	X	-	
1.9 GT	1985.09	1989.08	86	117	-	4	1/4	AM5	AMU5	X	-	
1.9 LX	1988.05	1989.08	67	91	-	4	1/4	AM5	AMU5	X	-	
1.9 GT	1988.05	1989.08	82	111	-	4	1/4	AM5	AMU5	X	-	
1.9	1989.09	1990.08	67	91	-	4	1/4	AM5	AMU5	X	-	
1.9	1990.04	1996.05	65	88	-	4	1/4	AM1	AMU1	X	-	
1.9 LX	1991.09	1996.05	65	88	-	4	1/4	AM1	AMU1	X	-	
2.0 Si	1993.04	1996.05	93	126	-	4	-/4	AM80	AMU80	X	-	
2.0 SE	1996.06	2001.09	82	111	-	4	-/4	AM80	AMU80	X	-	
EXCURSION												
4.6	2000.01	2004.12	160	218	-	8	-	-	-	JM5076	8	JM1190 VIN (6), VIN (W)
4.6 4WD	2000.01	2004.12	160	218	-	8	-	-	-	JM5076	8	JM1190 VIN (6), VIN (W)
4.6 V8 SOHC	2005.12	-->	-	-	-	8	-	-	-	JM5089	8	JM1197; VIN (W)
5.4	1996.09	2002.12	172	234	-	8	-	-	-	JM5076	8	JM1190; VIN (L)
5.4 4WD	1996.09	2002.12	172	234	-	8	-	-	-	JM5076	8	JM1190; VIN (L)
5.4 V8 SOHC	1997.01	2004.12	-	-	-	8	-	-	-	JM5076	8	JM1190; VIN (L)
5.4	1999.09	2005.12	190	258	-	8	-	-	-	JM5076	8	JM1190; VIN (L)
5.4 4WD	1999.09	2005.12	190	258	-	8	-	-	-	JM5076	8	JM1190; VIN (L)
5.4 V8 SOHC	2000.01	2005.12	-	-	-	8	-	-	-	JM5076	8	JM1190; VIN (L)
5.4	2002.09	2004.12	172	230	-	8	-	-	-	JM5076	8	JM1190; VIN (L)
5.4 4WD	2002.09	2004.12	172	230	-	8	-	-	-	JM5076	8	JM1190; VIN (L)
5.4	2002.10	2006.02	194	264	-	8	-	-	-	JM5089	8	JM1197
5.4	2004.09	2006.12	224	305	-	8	-	-	-	JM5089	8	JM1197; VIN (S)
5.4 4WD	2004.09	2006.12	224	305	-	8	-	-	-	JM5089	8	JM1197; VIN (S)
5.4 V8 SOHC	2005.01	-->	-	-	-	8	-	-	-	JM5089	8	JM1197 VIN (5), VIN (L)
5.4 V8 SOHC	2006.01	-->	-	-	-	8	-	-	-	JM5089	8	JM1197; VIN (5)
6.4 V10 SOHC	2000.01	2005.12	-	-	-	10	-	-	-	JM5076	10	JM1190; VIN (S)
6.8	1999.09	2005.12	231	314	-	10	-	-	-	JM5076	10	JM1190; VIN (S)
6.8 4WD	1999.09	2005.12	231	314	-	10	-	-	-	JM5076	10	JM1190; VIN (S)
EXPLORER												
3.5	2010.10	-->	216	294	-	6	-	X	X	JM5498	6	
3.5 AWD	2010.10	-->	216	294	-	6	-	X	X	JM5498	6	
4.0 V6 Allrad	1993.01	1996.12	121	165	-	6	-/6	FS19	FU19	JM5074	1	VIN (X)
4.0	1994.11	1996.08	115	156	-	6	-/6	FS19	FU19	X	-	
4.0 V6 Allrad	1995.03	-->	115	156	-	6	-/6	FS42	FU42	JM5074	1	
4.0	1996.09	2002.08	152	207	-	6	-/6	FS42	FU42	JM5074	1	
4.0 V6 Allrad	1997.01	2000.12	121	165	-	6	-/6	FS42	FU42	JM5074	1	VIN (X)
4.0 V6 Allrad	1997.01	2000.12	121	165	-	6	-	X	X	JM5074	1	VIN (E); LHD
4.0 V6 Allrad	1997.01	2001.12	121	165	-	6	-	X	X	JM5074	1	VIN (E); RHD
4.0 V6 Allrad	1998.05	-->	152	207	-	6	-/6	FS42	FU42	JM5074	1	
4.0 V6 Allrad	1998.10	-->	150	204	-	6	-/6	FS42	FU42	JM5074	1	
4.0	1999.10	2003.04	150	204	-	6	-/6	FS42	FU42	JM5074	1	
4.0 V6 Allrad	2001.01	2001.12	121	165	-	6	-	X	X	JM5074	1	VIN (E); LHD
4.0 V6 Allrad	2002.01	2004.12	121	165	-	6	-	X	X	JM5074	1	
4.0 Flex-Fuel 4WD	2002.01	-->	156	212	-	6	-/6	FS42	FU42	X	-	
4.0 V6 Allrad	2005.01	2010.12	121	165	-	6	-	X	X	JM5074	1	SOHC
4.6 V8 SOHC	2002.01	2005.12	-	-	-	8	-	-	-	JM5076	8	JM1190; VIN (W)
4.6 4x4	2003.05	-->	178	242	-	8	-	-	-	JM5089	8	JM1197
4.6 V8 SOHC	2006.01	2006.12	-	-	-	8	-	-	-	JM5076	8	JM1190; VIN (8)
4.6 V8 SOHC	2006.01	2006.12	-	-	-	8	-	-	-	JM5076	8	JM1190; VIN (L)
4.6	2006.05	-->	218	296	-	8	-	-	-	JM5089	8	JM1197
4.6 4x4	2006.05	-->	218	296	-	8	-	-	-	JM5089	8	JM1197
4.6 V8 SOHC	2007.01	2008.12	-	-	-	8	-	-	-	JM5089	8	JM1197; VIN (3), VIN (8), VIN (A), VIN (L), VIN (W)
4.9 V8 4x4	1996.01	2001.12	157	213	-	8	-/8	AM95	AMU95	JM5092	2	VIN (P)
F-53												
6.8	1999.09	2001.12	231	310	-	10	-	-	-	JM5076	10	JM1190
6.8	2002.09	2004.12	231	310	-	10	-	-	-	JM5076	10	JM1190
6.8	2005.01	2007.12	231	310	-	10	-	-	-	JM5089	10	JM1197
F-100												
5.8	1965.09	1967.12	127	170	-	8	1/8	AM96	AMU96	X	-	
5.8	1976.09	1979.12	105	143	-	8	1/8	AM96	AMU96	X	-	



FORD USA											
<b>F-150</b>											
3.7 Flexfuel	2010.09	-->	225	302	-	6		X	X	JM5498	6
3.7 FLEX 4WD	2011.09	-->	225	302	-	6		X	X	JM5498	6
4.2 12V	1997.01	2007.12	151	205		6		X	X	JM5075	1
4.6 V8 SOHC	2004.01	-->	-	-	-	8	-	-	-	JM5076	8 JM1190; VIN (W)
4.6 V8 SOHC	2004.01	-->	-	-	-	8	-	-	-	JM5089	8 JM1197; VIN (W)
4.6 V8 SOHC	2005.01	-->	-	-	-	8	-	-	-	JM5076	8 JM1190; VIN (X), VIN (W)
4.9	1991.10	1996.09	110	150	-	6	1/6	AM81	AMU81	X	- VIN (V)
4.9 XL	1992.10	1996.09	106	144	-	6	1/6	AM81	AMU81	X	- VIN (W)
5.0 Flexfuel	2010.09	-->	268	360	-	8	-	-	-	JM5486	8
5.0 Flexfuel 4WD	2010.09	-->	268	360	-	8	-	-	-	JM5486	8
5.0 FLEX	2011.09	-->	268	360	-	8		X	X	JM5486	8
5.0 FLEX 4WD	2011.09	-->	268	360	-	8		X	X	JM5486	8
5.4 V8 SOHC	1997.01	2003.12	-	-	-	8	-	-	-	JM5076	8 JM1190; VIN (L)
5.4 V8 SOHC BI-FUEL	1998.01	2003.12	-	-	-	8	-	-	-	JM5076	8 JM1190; VIN (Z)
5.4 V8 SOHC CNG	1998.01	2003.12	-	-	-	8	-	-	-	JM5076	8 JM1190; VIN (M)
5.4 V8 Supercharger SOHC	1999.01	2003.12	-	-	-	8	-	-	-	JM5076	8 JM1190; VIN (3), VIN (W)
5.4 V8 BI-FUEL	2004.01	-->	-	-	-	8	-	-	-	JM5089	8 JM1197; VIN (Z)
5.4 V8 CNG	2004.01	-->	-	-	-	8	-	-	-	JM5089	8 JM1197; VIN (M)
5.4 V8 Supercharger SOHC	2004.01	-->	-	-	-	8	-	-	-	JM5089	8 JM1197; VIN (3)
5.4 SVT 4x4	2004.02	2007.09	194	264	-	8	-	-	-	JM5089	8 JM1197; VIN (V)
5.4 V8 SOHC	2005.01	2008.12	-	-	-	8	-	-	-	JM5089	8 JM1197; VIN (5), VIN (8)
5.4 V8 SOHC FLEX	2006.01	-->	-	-	-	8	-	-	-	JM5089	8 JM1197; VIN (V)
5.4 V8 SOHC	2007.01	2008.12	-	-	-	8	-	-	-	JM5089	8 JM1197; VIN (W)
5.4 V8 SOHC FLEX	2007.01	2008.12	-	-	-	8	-	-	-	JM5089	8 JM1197; VIN (8)
<b>F-250</b>											
5.4 V8 SOHC	1997.01	-->	-	-	-	8	-	-	-	JM5076	8 JM1190; VIN (L)
5.4 V8 SOHC	2000.01	2004.12	-	-	-	8	-	-	-	JM5076	8 JM1190; VIN (L)
5.4 V8 SOHC	2005.01	-->	-	-	-	8	-	-	-	JM5089	8 JM1197; VIN (5)
5.4 V8 SOHC	2008.01	-->	-	-	-	8	-	-	-	JM5089	8 JM1197; VIN (5)
5.4 V8 SOHC	2006.01	2008.12	-	-	-	8	-	-	-	JM5089	8 JM1197; VIN (5)
5.4 V8 SOHC Bi-Fuel	1997.01	1999.12	-	-	-	8	-	-	-	JM5076	8 JM1190; VIN (Z)
5.4 V8 SOHC Bi-Fuel	1999.01	-->	-	-	-	8	-	-	-	JM5076	8 JM1190; VIN (Z)
5.4 V8 SOHC CNG	1997.01	1999.12	-	-	-	8	-	-	-	JM5076	8 JM1190; VIN (M)
6.8 V10 SOHC	2000.01	2004.12	-	-	-	10	-	-	-	JM5076	10 JM1190; VIN (S)
6.8 V10 SOHC	2005.01	-->	-	-	-	10	-	-	-	JM5089	8 JM1197; VIN (S)
6.8 V10 SOHC	2005.01	-->	-	-	-	10	-	-	-	JM5089	8 JM1197; VIN (Y)
6.8 V10 SOHC	2008.01	-->	-	-	-	10	-	-	-	JM5089	8 JM1197; VIN (Y)
<b>F-350</b>											
5.4 V8 SOHC	1999.01	2004.12	-	-	-	8	-	-	-	JM5076	8 JM1190; VIN (L)
5.4 V8 SOHC	2005.01	-->	-	-	-	8	-	-	-	JM5089	8 JM1197; VIN (5), VIN (L)
5.4 V8 SOHC	2006.01	-->	-	-	-	8	-	-	-	JM5089	8 JM1197; VIN (5)
6.8 V10 SOHC	1999.01	2004.12	-	-	-	10	-	-	-	JM5076	10 JM1190; VIN (S)
6.8 V10 SOHC	2005.01	-->	-	-	-	10	-	-	-	JM5089	10 JM1197; VIN (S)
6.8 V10 SOHC	2005.01	-->	-	-	-	10	-	-	-	JM5089	10 JM1197; VIN (Y)
<b>F-450</b>											
6.8 V10 SOHC	1999.01	2004.12	-	-	-	10	-	-	-	JM5076	10 JM1190; VIN (S)
6.8 V10 SOHC	2005.01	2007.12	-	-	-	10	-	-	-	JM5076	10 JM1190; VIN (Y)
7.5	1996.09	1997.12	183	249	-	8	-	-	-	JM5076	8 JM1190; Mexico
<b>F-550</b>											
6.8 V10 SOHC	1999.01	2004.12	-	-	-	10	-	-	-	JM5076	10 JM1190; VIN (S)
6.8 V10 SOHC	2005.01	2007.12	-	-	-	10	-	-	-	JM5076	10 JM1190; VIN (Y)
<b>FAIRLANE</b>											
5.8	1958.09	1970.12	164	223	-	8	1/8	AM96	AMU96	X	-
<b>FESTIVA</b>											
1.3 8V	1990.01	1993.12	43	58	-	4		X	X	JM5337	1
<b>FIVE HUNDRED</b>											
3.0	2004.08	-->	151	205	183cid	6	-	-	-	JM5340	6 VIN (1)
3.0 4x4	2004.08	-->	151	205	183cid	6	-	-	-	JM5340	6 VIN (1)
3.0 24V	2005.01	2007.12	169	227	-	6	-	-	-	JM5340	6 VIN (1)
<b>FLEX</b>											
3.5	2008.09	2011.12	195	266	-	6	-	-	-	JM5498	6 VIN (C)



<b>FORD USA</b>												
<b>FOCUS</b>												
2.0	1999.09	2004.12	97	132	-	4	-/4	AM93	AMU93	X	-	
2.0 DOHC	2003.01	2008.12	-	-	-	4	-	-	-	JM5059	4	VIN (N)
2.0 16V	2005.01	2007.12	101	137	-	4	-	-	-	JM5059	4	VIN (N)
2.3 16V	2003.01	2004.12	-	-	140cid	4	-	-	-	JM5059	4	VIN (Z)
2.3 16V	2003.01	2007.12	113	154	-	4	-	-	-	JM5059	4	VIN (Z)
2.3 DOHC	2003.01	-->	-	-	-	4	-	-	-	JM5059	4	VIN (Z)
<b>FREESTAR</b>												
3.8	2003.10	2007.09	147	200	-	6		X	X	JM5074	1	
3.9 12V	2004.01	2007.12	144	196		6		X	X	JM5075	1	
4.2 12V	2004.01	2007.12	150	204		6		X	X	JM5075	1	
<b>FREESTYLE</b>												
3.0 24V	2005.01	2007.12	169	227	183cid	6	-	-	-	JM5340	6	VIN (1)
3.0 24V AWD	2005.01	2007.12	169	227	183cid	6	-	-	-	JM5340	6	VIN (1)
<b>FUSION</b>												
2.3	2005.09	2006.12	121	165	-	4	-	-	-	JM5610	4	VIN (Z) OE 6E5Z12029AA
2.3	2008.09	2009.12	119	160	-	4	-	-	-	JM5610	4	VIN (Z) OE 6E5Z12029AA
2.5	2009.09	2011.12	143	191	-	4	-	-	-	JM5617	4	VIN (3), VIN (A) GREY ign.coil boots
2.5	2010.09	2011.12	130	174	-	4	-	-	-	JM5617	4	VIN (3), VIN (A) GREY ign.coil boots
2.5 AWD	2010.09	2011.12	130	174	-	4	-	-	-	JM5617	4	VIN (3), VIN (A) GREY ign.coil boots
2.5	2010.09	2011.12	131	175	-	4	-	-	-	JM5617	4	VIN (3), VIN (A) GREY ign.coil boots
2.5 Hybrid	2011.09	2011.12	116	156	-	4	-	-	-	JM5617	4	VIN (3), VIN (A) GREY ign.coil boots
2.5	2012.09	-->	127	173	-	4	-	-	-	JM5617	4	VIN (3), VIN (A) GREY ign.coil boots
3.0	2005.09	2009.12	165	224	-	6	-	-	-	JM5600	6	VIN (1)
3.0 AWD	2006.09	2008.12	165	224	-	6		X	X	JM5600	6	VIN (1)
3.0	2009.09	2010.12	179	240	99G	6	-	-	-	JM5600	6	VIN (G)
3.0 Flexfuel	2009.09	2011.12	179	240	99G	6	-	-	-	JM5600	6	VIN (G)
3.0 Flexfuel AWD	2009.09	2011.12	179	240	99G	6	-	-	-	JM5600	6	VIN (G)
3.5	2008.09	2009.09	196	266	-	6	-	-	-	JM5498	6	VIN (C)
3.5 4x4	2009.09	2010.12	196	266	-	6	-	-	-	JM5498	6	VIN (C)
<b>GALAXIE</b>												
5.8	1959.09	1960.12	224	305	-	8	1/8	AM96	AMU96	X	-	
5.8	1968.09	1974.12	114	155	-	8	1/8	AM96	AMU96	X	-	
<b>GRAND MARQUIS</b>												
4.6	1997.09	2001.12	157	214	-	8	-	-	-	JM5076	8	JM1190; Mexico
4.6	2002.01	2002.12	157	214	-	8	-	-	-	JM5076	8	JM1190; USA
4.6	2002.09	2004.12	178	242	-	8	-	-	-	JM5076	8	JM1190; USA
<b>GT</b>												
5.4	2003.06	-->	368	500	-	8	-	-	-	JM5088	8	JM1193
<b>LOBO</b>												
4.6	2003.09	2004.12	185	252	-	8	-	-	-	JM5076	8	JM1190; Mexico
4.6	2003.09	2004.12	218	296	-	8	-	-	-	JM5076	8	JM1190; Mexico
5.4	2000.09	2004.12	194	264	-	8	-	-	-	JM5076	8	JM1190; Mexico
5.4	2000.09	2004.12	224	305	-	8	-	-	-	JM5076	8	JM1190; Mexico
5.4	2001.09	2003.12	194	264	-	8	-	-	-	JM5076	8	JM1190; Mexico
5.4 4WD	2004.09	2004.12	224	305	-	8	-	-	-	JM5076	8	JM1190; Mexico
<b>LTD</b>												
5.8	1968.09	1974.12	114	155	-	8	1/8	AM96	AMU96	X	-	
<b>M-400</b>												
5.9	1972.09	1973.12	141	192	-	8	1/8	AM96	AMU96	X	-	
<b>M-450</b>												
5.9	1973.09	1974.12	-	-	-	-	1/8	AM96	AMU96	X	-	
<b>MUSTANG</b>												
2.3	1988.01	1993.12	-	-	-	4	1/4	AM40	AMU40	X	-	
3.7	2010.09	2011.12	227	305	99M	6	-	-	-	JM5498	6	VIN (M)
3.8 12V	1984.01	2004.12	91	124		6		X	X	JM5075	1	
3.8	1993.09	2000.12	82	110	-	6		X	X	JM5073	1	VIN (4)
3.8	1993.09	2000.12	90	120	-	6		X	X	JM5073	1	VIN (4)
3.8	1993.09	2000.12	91	124	-	6		X	X	JM5073	1	VIN (4)
3.8	1993.09	-->	112	152	-	6	-/6	AM12	AMU12	X	-	
3.8	1994.01	1999.05	108	147	-	6	-/6	AM49	AMU49	X	-	



FORD USA												
<b>MUSTANG</b>												
4.0 V6	2004.12	-->	157	214	-	6	-/6	FS42	FU42	JM5074	1	
4.6	1995.09	2003.12	231	314	-	8	-	-	-	JM5076	8	JM1190; VIN (R)
4.6	1995.11	1999.05	160	218	-	8	-/8	AM50	AMU50	X	-	
4.6	1995.11	1999.05	165	224	-	8	-/8	AM50	AMU50	X	-	
4.6	1995.11	1999.05	225	306	-	8	-/8	AM50	AMU50	X	-	
4.6 V8 SOHC	1999.01	2004.12	-	-	-	8	-	-	-	JM5076	8	JM1190; VIN (X)
4.6	1999.01	1999.12	160	218	-	8	-	-	-	JM5076	8	JM1190; VIN (X)
4.6	1999.01	2001.12	160	218	-	8	-	-	-	JM5088	8	JM1193; VIN (Y)
4.6	1999.01	2001.12	231	314	-	8	-	-	-	JM5088	8	JM1193; VIN (Y)
4.6	1999.01	1999.12	231	314	-	8	-	-	-	JM5076	8	JM1190; VIN (X)
4.6	1999.06	2003.09	236	321	-	8	-	-	-	JM5088	8	JM1193
4.6 V8 SOHC	2001.01	-->	-	-	-	8	-	-	-	JM5076	8	JM1190; VIN (X)
4.6	2001.01	2004.12	160	218	-	8	-	-	-	JM5076	8	JM1190; VIN (X)
4.6	2002.01	2004.12	231	314	-	8	-	-	-	JM5076	8	JM1190; VIN (X)
4.6	2003.01	2004.12	160	218	-	8	-	-	-	JM5088	8	JM1193; VIN (Y)
4.6	2003.01	2004.12	160	218	-	8	-	-	-	JM5076	8	JM1190; VIN (R)
4.6	2003.01	2004.12	231	314	-	8	-	-	-	JM5088	8	JM1193; VIN (Y)
4.6 V8	2004.12	-->	224	305	-	8	-	-	-	JM5089	8	JM1197
4.6 V8	2005.12	-->	224	305	-	8	-	-	-	JM5089	8	JM1197
4.6 V8 SOHC	2008.01	-->	-	-	-	8	-	-	-	JM5089	8	JM1197; VIN (H)
4.9	1993.09	1995.12	160	218	-	8	2/8	AM51	AMU51	JM5365	1	VIN (D), VIN (T)
5.0	1986.09	1992.12	104	141	-	8	1/8	AM91	AMU91	X	-	
5.4 V8	2006.01	-->	355	483	-	8	-	-	-	JM5088	8	JM1193
5.0	2010.09	2011.12	307	412	-	8	-	-	-	JM5486	8	
5.0	2012.01	-->	313	426	-	8	-	X	X	JM5486	8	
<b>P-350</b>												
5.9	1972.09	1973.12	141	192	-	8	1/8	AM96	AMU96	X	-	
<b>PROBE</b>												
2.0	1992.09	1995.12	86	117	-	4		X	X	JM5092	1	wo / Dist.; VIN (A)
2.0	1992.09	1997.12	86	117	-	4		X	X	JM5302	1	Dist. T6T57871, FS01-18-200A; ATM; w / Dist.
2.0	1992.09	1997.12	86	117	-	4		X	X	JM5365	1	Dist. T2T53871, FS07-18-200; MTM; w / Dist.
2.0	1992.09	1997.12	86	117	-	4		X	X	JM5307	1	Dist. T2T57971, FB1318200A; w / Dist.
2.0 16V	1993.10	1995.12	85	116	FS	4		X	X	JM5092	1	wo / Dist.; VIN (A)
2.0 16V	1993.10	1998.03	85	116	FS	4	-/4	JP155	JPE155	JM5302	1	Dist. T6T57871, FS01-18-200A; ATM; w / Dist.;
2.0 16V	1993.10	1998.03	85	116	FS	4		X	X	JM5365	1	Dist. T2T53871, FS07-18-200; MTM; w / Dist.
2.0 16V	1993.10	1998.03	85	116	FS	4		X	X	JM5307	1	Dist. T2T57971, FB1318200A; w / Dist.
2.0 16V	1996.01	1998.03	85	116	FS	4		X	X	JM5365	1	w / Dist.; VIN (A)
2.2	1988.08	1993.07	82	112	-	4	1/4	FS41	FU41	X	-	
2.2 GT	1988.08	1992.12	108	147	-	4	1/4	FS41	FU41	JM5152	1	
2.2 GT	1990.01	-->	-	-	-	6	1/6	FS18	FU18	X	-	
2.5 24V	1993.01	1997.12	122	166	-	6		X	X	JM5304	1	Dist. T0T57071
2.5 V6 24V	1993.10	1998.03	119	162	KL	6	-/6	FS22	FU22	X	-	
2.5 V6 24V	1993.10	1998.03	119	162	KL	6		X	X	JM5308	1	Dist. T0T57271
2.5 V6 24V	1994.12	1998.03	120	163	KL	6	-/6	FS22	FU22	JM5308	1	
3.0 V6	1989.09	1993.07	104	141	-	6	1/6	AM6	AMU6	X	-	
<b>RANCH WAGON</b>												
5.8	1968.09	1974.12	114	155	-	8	1/8	AM96	AMU96	X	-	
<b>RANCHERO</b>												
5.8	1974.09	1976.12	106	144	-	8	1/8	AM96	AMU96	X	-	
<b>RANGER</b>												
2.2	1999.10	-->	-	-	-	4	1/4	AM76	AMU76	X	-	
2.3	1988.09	1997.12	65	88	-	4		X	X	JM5092	2	VIN (A)
2.3 4WD	1988.09	1997.12	65	88	-	4		X	X	JM5092	2	VIN (A)
2.3	1990.10	1995.12	72	98	-	4		X	X	JM5092	2	VIN (A)
2.3	2000.09	2003.12	101	137	-	4		X	X	JM5091	1	VIN (D)
2.3 4WD	2000.09	2003.12	101	137	-	4		X	X	JM5091	1	VIN (D)
2.3 4WD	2000.09	2006.12	108	147	-	4		X	X	JM5091	1	VIN (D)
2.3	2006.09	2011.12	107	143	-	4		X	X	JM5091	1	VIN (D)
2.3 4WD	2006.09	2011.12	107	143	-	4		X	X	JM5091	1	VIN (D)
2.5	1997.09	2001.12	87	118	-	4		X	X	JM5092	1	VIN (C)
2.5 4WD	1997.09	2001.12	87	118	-	4		X	X	JM5092	1	VIN (C)
2.5	1997.09	2001.12	90	122	-	4		X	X	JM5092	1	VIN (C)



## FORD USA

RANGER													
2.5 4WD	1997.09	2001.12	90	122	-	4			X	X	JM5092	1	VIN (C)
2.5	2000.09	2001.12	89	121	-	4			X	X	JM5092	1	VIN (C)
2.5 4WD	2000.09	2001.12	89	121	-	4			X	X	JM5092	1	VIN (C)
3.0 Flexfuel	1990.09	2000.12	108	147	-	6			X	X	JM5073	1	Vertical coil conn. plug VIN (U)
3.0 Flexfuel	1990.09	2000.12	108	147	-	6			X	X	JM5075	1	Horizontal coil conn. plug; VIN (U)
3.0 Flexfuel 4WD	1990.09	2000.12	108	147	-	6			X	X	JM5073	1	Vertical coil conn. plug VIN (U), VIN (V)
3.0 Flexfuel 4WD	1990.09	2000.12	108	147	-	6			X	X	JM5075	1	Horizontal coil conn. plug; VIN (U), VIN (V)
3.0	1990.10	1996.12	99	135	-	6	1/6	AM38	AMU38	X	-		
3.0 4x4	1990.10	1996.12	99	135	-	6	1/6	AM38	AMU38	X	-		
3.0 12V	1991.01	2006.12	108	147	-	6		X	X	JM5075	1		
3.0	1995.01	1995.12	108	147	-	6		X	X	JM5365	1	w / Dist.	
3.0 4WD	1995.01	1995.12	108	147	-	6		X	X	JM5365	1	w / Dist.	
3.0	1995.01	1998.12	108	147	-	6		X	X	JM5073	1	Vertical coil conn. plug VIN (U)	
3.0 4WD	1995.01	1997.12	108	147	-	6		X	X	JM5073	1	Vertical coil conn. plug VIN (U)	
3.0 4WD	1995.01	1997.12	108	147	-	6		X	X	JM5075	1	Horizontal coil conn. plug; VIN (U)	
3.0	1998.01	2000.12	108	147	-	6		X	X	JM5073	1	Vertical coil conn. plug VIN (U), VIN (V)	
3.0	1998.01	2000.12	108	147	-	6		X	X	JM5075	1	Horizontal coil conn. plug; VIN (U), VIN (V)	
3.0 4WD	1998.01	2000.12	108	147	-	6		X	X	JM5073	1	Vertical coil conn. plug VIN (U), VIN (V)	
3.0 4WD	1998.01	2000.12	108	147	-	6		X	X	JM5075	1	Horizontal coil conn. plug; VIN (U), VIN (V)	
3.0 V6	2005.01	-->	-	-	-	6		X	X	JM5075	1		
SABLE													
2.0 V6	1987.01	1993.12	-	-	-	6	1/6	AM6	AMU6	X	-		
SUNLINER													
5.8	1957.09	1964.12	-	-	-	-	1/8	AM96	AMU96	X	-		
TAURUS													
2.5	1987.01	-->	-	-	-	4	1/4	AM2	AMU2	X	-		
2.5	1991.01	-->	-	-	-	4	1/4	AM4	AMU4	X	-		
3.0 12V	1986.01	2005.12	104	141	-	6		X	X	JM5075	1		
3.0	1987.01	-->	-	-	-	6	1/6	AM6	AMU6	X	-		
3.0	1995.09	2000.12	104	140	-	6		X	X	JM5073	1	VIN (U); OHV	
3.0	1995.09	2000.12	104	140	-	6		X	X	JM5073	1	VIN (S); DOHC	
3.0 Flexfuel	1995.09	2000.12	104	140	-	6		X	X	JM5073	1	VIN (2)	
3.0 24V	1996.01	2005.12	108	147	-	6		X	X	JM5075	1		
3.0	1996.09	2000.12	108	147	-	6	1/6	AM11	AMU11	JM5074	1	VIN (U)	
3.0 24V	1996.09	2000.12	108	147	-	6	1/6	AM11	AMU11	JM5074	1	VIN (S)	
3.0 24V	1996.09	2000.12	149	203	-	6	1/6	AM11	AMU11	JM5074	1	VIN (S)	
3.0 V6	1999.03	2004.12	115	156	-	6	-	-	-	JM5340	6	VIN (S)	
3.0	1999.09	2000.12	104	140	-	6		X	X	JM5340	6	VIN (S); DOHC	
3.0	1999.09	2005.12	104	140	-	6		X	X	JM5293	6	VIN (S); DOHC	
3.0	1999.09	2000.12	104	140	-	6		X	X	JM5073	1	VIN (S); DOHC	
3.0	1999.09	2000.12	108	147	-	6		X	X	JM5340	6	VIN (S); DOHC	
3.0	1999.09	2000.12	108	147	-	6		X	X	JM5073	1	VIN (S); DOHC	
3.0	2000.01	2000.12	95	129	183cid	6	-	-	-	JM5340	6	VIN (S)	
3.0	2001.01	2007.12	104	140	-	6		X	X	JM5075	1	VIN (U); OHV	
3.0	2001.01	2003.12	104	140	-	6		X	X	JM5075	1	VIN (S); DOHC	
3.0	2001.01	2007.12	108	147	-	6		X	X	JM5075	1	VIN (U); VIN (S)	
3.0 Flexfuel	2001.01	2006.12	104	140	-	6		X	X	JM5075	1	VIN (2)	
3.0 24V	2001.01	2007.12	108	147	-	6		X	X	JM5075	1	VIN (S)	
3.0 24V	2001.01	2007.12	149	203	-	6		X	X	JM5075	1	VIN (S)	
3.0	2004.01	2004.12	95	129	183cid	6	-	-	-	JM5340	6	VIN (S)	
3.0	2004.01	2004.12	104	140	-	6		X	X	JM5340	6	VIN (S); DOHC	
3.0	2004.01	2004.12	108	147	-	6		X	X	JM5340	6	VIN (S); DOHC	
3.0	2005.01	2005.12	108	147	-	6		X	X	JM5293	6	VIN (S); DOHC	
3.0 V6	2005.01	-->	-	-	-	6		X	X	JM5075	1		
3.4	1995.09	1999.12	175	238	-	8	-	-	-	JM5474	8	JM1198; VIN (N)	
3.4 SHO	1996.05	1998.10	175	238	-	8	-	-	-	JM5474	8	JM1198; VIN (N)	
3.5	2007.09	2009.12	196	267	-	6	-	-	-	JM5498	6	VIN (W)	
3.5 AWD	2007.09	2009.12	196	267	-	6	-	-	-	JM5498	6	VIN (W)	
3.5	2007.09	2008.12	194	260	-	6	-	-	-	JM5498	6	VIN (W); wo / Turbo	



**FORD USA**

3.5 AWD	2007.09	2008.12	194	260	-	6	-	-	-	JM5498	6	VIN (W); wo / Turbo
3.5	2008.09	-->	196	267	-	6	-	-	-	JM5498	6	VIN (W); wo / Turbo
3.5 AWD	2008.09	-->	196	267	-	6	-	-	-	JM5498	6	VIN (W); wo / Turbo
3.5	2012.01	-->	216	294	-	6	-	X	X	JM5498	6	wo / Turbo
3.5 AWD	2012.01	-->	216	294	-	6	-	X	X	JM5498	6	wo / Turbo
<b>TEMPO</b>												
2.3	-	-	-	-	-	4	1/4	AM4	AMU4	X	-	
3.0	-	-	-	-	-	6	1/6	AM6	AMU6	X	-	
<b>THUNDERBIRD</b>												
3.8	1988.09	1995.12	82	110	-	6	-	X	X	JM5073	1	wo / Dist.; VIN (R)
3.8	1988.09	1996.12	82	110	-	6	-	X	X	JM5365	1	w / Dist.; VIN (4)
3.8	1989.09	1995.12	106	144	-	6	-	X	X	JM5073	1	wo / Dist.; VIN (R)
3.8	1989.09	1995.12	106	144	-	6	-	X	X	JM5365	1	w / Dist.; VIN (4)
3.8	1990.01	1996.12	-	-	-	6	-/6	AM20	AMU20	X	-	
3.8	1994.01	1997.12	82	110	-	6	-	X	X	JM5073	1	wo / Dist.; VIN (4)
3.8	1996.01	1996.12	82	110	-	6	-	X	X	JM5365	1	w / Dist.; VIN (4) Exc. California
3.9 V8 DOHC 242 cid.	2002.01	2005.12	-	-	-	8	-	X	X	JM5078	8	VIN (A)
4.6	1993.01	1997.12	151	205	99W	8	-	X	X	JM5092	2	VIN (W)
4.6	1993.09	1995.12	110	150	-	8	-	X	X	JM5092	2	VIN (W)
4.6	1995.09	1997.12	155	211	-	8	-	X	X	JM5092	2	VIN (W)
5.0	1988.01	1992.12	-	-	-	8	2/8	AM39	AMU39	X	-	
5.8	1957.09	1960.12	-	-	-	8	1/8	AM96	AMU96	X	1	U=12 [V]
<b>TORINO</b>												
5.8	1968.09	1974.12	114	155	-	8	1/8	AM96	AMU96	X	-	
5.8	1974.09	1976.12	107	146	-	8	1/8	AM96	AMU96	X	-	
<b>TRANSIT CONNECT</b>												
2.0	2010.01	2010.12	-	-	121cid	4	-	-	-	JM5059	4	VIN (N)
<b>VICTORIA</b>												
5.8	1957.09	1964.12	-	-	-	8	1/8	AM96	AMU96	X	1	U=12 [V]
<b>WINDSTAR</b>												
3.8	1994.09	1998.12	116	158	-	6	-	X	X	JM5073	1	VIN (4)
3.8 V6	1995.01	2000.12	149	203	-	6	-/6	FS24	FU24	JM5074	1	
3.0	1994.09	2000.12	110	150	-	6	-	X	X	JM5073	1	VIN (U)
3.0 V6	1995.03	1999.02	109	148	-	6	-	X	X	JM5073	1	
3.8 12V	1999.01	2003.12	116	158	-	6	-	X	X	JM5075	1	
3.0 V6	1999.02	-->	108	147	-	6	-	X	X	JM5073	1	
3.8	1999.01	2003.12	116	158	-	6	-	X	X	JM5073	1	VIN (4)
3.8 V6	2001.01	2003.12	149	203	-	6	-	X	X	JM5075	1	
<b>FPV</b>												
<b>FALCON COBRA</b>												
5.4	2007.10	2008.05	290	394	BOSS 302	8	-	-	-	JM5088	8	JM1193
<b>FALCON F6</b>												
4.0	2008.02	2009.03	310	421	BARRA 270T	6	-	-	-	JM5087	6	
4.0	2008.06	-->	310	421	BARRA 310T	6	-	-	-	JM5087	6	
4.0	2008.06	-->	310	422	BARRA 290T	6	-	-	-	JM5087	6	
<b>FALCON FORCE 6</b>												
4.0	2006.11	2008.05	270	367	BARRA 270T	6	-	-	-	JM5087	6	
<b>FALCON FORCE 8</b>												
5.4	2006.11	2008.01	290	394	BOSS 290	8	-	-	-	JM5088	8	JM1193
<b>FALCON GS PICK-UP</b>												
5.0	2010.10	-->	315	428	-	8	-	X	X	JM5486	8	
<b>FALCON GT</b>												
5.0	2010.10	-->	335	456	BOSS 335	8	-	X	X	JM5486	8	
5.4	2003.03	2005.09	290	394	BOSS 290	8	-	-	-	JM5088	8	JM1193
5.4	2004.10	2006.01	290	394	BOSS 290	8	-	-	-	JM5088	8	JM1193
5.4	2005.10	2008.01	290	394	BOSS 290	8	-	-	-	JM5088	8	JM1193
5.4	2007.10	2008.05	302	411	BOSS 302	8	-	-	-	JM5088	8	JM1193
5.4	2008.06	2010.09	315	428	BOSS 315	8	-	-	-	JM5088	8	JM1193
<b>FALCON PURSUIT</b>												
5.4	2003.03	2005.09	290	394	BOSS 290	8	-	-	-	JM5088	8	JM1193
5.4	2005.10	2008.01	270	367	BOSS 290	8	-	-	-	JM5088	8	JM1193
5.4	2008.06	2010.09	315	428	BOSS 315	8	-	-	-	JM5088	8	JM1193



## FPV

FALCON SUPER PURSUIT													
5.4	2004.10	2006.01	290	394	BOSS 290	8	-	-	-	-	JM5088	8	JM1193
5.4	2005.10	2008.01	290	394	BOSS 290	8	-	-	-	-	JM5088	8	JM1193
5.4	2008.06	2010.09	315	428	BOSS 315	8	-	-	-	-	JM5088	8	JM1193

FALCON TORNADO													
4.0	2004.10	2006.01	290	394	BARRA 270T	6	-	-	-	-	JM5087	6	
4.0	2005.11	2008.01	290	394	BARRA 270T	6	-	-	-	-	JM5087	6	

FALCON TYPHOON													
4.0	2004.10	2006.01	270	367	-	6	-	-	-	-	JM5087	6	
4.0	2005.10	2008.05	270	367	BARRA 270T	6	-	-	-	-	JM5087	6	

## GEO USA

PRIZM													
1.6 16V	1990.01	1991.12	76	103	-	4		X	X	X	JM5180	1	
1.6 DOHC	1996.01	1997.12	-	-	98cid	4		X	X	X	JM5145	1	VIN (6)
1.8 DOHC	1995.01	1997.12	-	-	110cid	4		X	X	X	JM5150	1	VIN (8)

STORM													
1.6 12V	1990.01	1993.12	71	97	-	4		X	X	X	JM5369	1	VIN (5), VIN (6)
1.6 16V	1990.01	1991.12	71	97	-	4		X	X	X	JM5369	1	VIN (5), VIN (6)
1.8 16V	1992.01	1993.12	104	141	-	4		X	X	X	JM5369	1	VIN (8)

## GMC

B6000													
5.7 V8	1990.01	1990.12	-	-	-	8		X	X	X	JM5367	1	350cid
6.0 V8	1990.01	1990.12	-	-	-	8		X	X	X	JM5367	1	366cid
6.0 V8	1991.01	1991.12	-	-	-	8		X	X	X	JM5369	1	366cid

JIMMY													
4.3	1989.01	1998.12	110	150	-	6	1/6	AM83	AMU83	X	-		
4.3 AWD	1989.01	1998.12	110	150	-	6	1/6	AM83	AMU83	X	-		
4.3	1996.01	1998.12	110	150	-	6		X	X	X	JM5385	1	VIN (W)
4.3 AWD	1996.01	1998.12	110	150	-	6		X	X	X	JM5385	1	VIN (W)
4.3	1996.01	1998.12	142	193	-	6		X	X	X	JM5385	1	VIN (W)
4.3 AWD	1996.01	1998.12	142	193	-	6		X	X	X	JM5385	1	VIN (W)

SAFARI													
4.3	1993.10	2004.09	142	193	-	6	1/6	AM83	AMU83	X	-		

SIERRA													
4.3	1996.05	2006.12	142	193	-	6		X	X	X	JM5385	1	VIN (W), VIN (X)
4.3 AWD	1996.05	2006.12	142	193	-	6		X	X	X	JM5385	1	VIN (W), VIN (X)
4.3	2007.01	2007.12	142	193	-	6		X	X	X	JM5496	1	VIN (X)
4.3 AWD	2007.01	2007.12	142	193	-	6		X	X	X	JM5496	1	VIN (X)
4.8	1999.05	2007.12	206	280	LR4	8		X	X	X	JM5473	8	sys. Mitsubishi; VIN (V)
4.8	1999.05	2007.12	206	280	LR4	8		X	X	X	JM5442	8	sys. Delphi; VIN (V)
4.8 AWD	1999.05	2007.12	206	280	LR4	8		X	X	X	JM5473	8	sys. Mitsubishi; VIN (V)
4.8 AWD	1999.05	2007.12	206	280	LR4	8		X	X	X	JM5442	8	sys. Delphi; VIN (V)
5.3	1998.10	2007.12	213	290	LM7	8		X	X	X	JM5473	8	sys. Mitsubishi; VIN (T)
5.3	1998.10	2007.12	213	290	LM7	8		X	X	X	JM5442	8	sys. Delphi; VIN (T)
5.3	2006.09	2010.12	232	315	LH6, LY5	8		X	X	X	JM5406	8	sys. Mitsubishi; VIN (O), VIN (3), VIN (J), VIN (Z)
5.3	2006.09	2010.12	232	315	LH6, LY5	8		X	X	X	JM5439	8	sys. Delphi; VIN (O), VIN (3), VIN (J), VIN (Z)
5.3 AWD	2006.09	2010.12	232	315	LH6, LY5	8		X	X	X	JM5406	8	sys. Mitsubishi; Mexico
5.3 AWD	2006.09	2010.12	232	315	LH6, LY5	8		X	X	X	JM5439	8	sys. Delphi; Mexico
5.3	2007.01	2007.12	213	290	LM7	8		X	X	X	JM5406	8	sys. Mitsubishi; VIN (M)
5.3	2007.01	2007.12	213	290	LM7	8		X	X	X	JM5439	8	sys. Delphi; VIN (M)

SUBURBAN													
5.7	1991.10	1999.09	157	213	LO5	8	1/8	AM88	AMU88	X	-		

YUKON													
5.7	1991.04	1996.08	157	213	-	8	1/8	AM88	AMU88	X	-		
5.7	1994.09	2000.04	149	203	LO5	8	1/8	AM88	AMU88	X	-		

## GMC USA

ACADIA													
3.6	2008.09	2011.12	215	288	-	6	-	-	-	-	JM5426	6	OE 12613057

C15													
4.1 12V	1975.01	1977.12	75	102	-	6		X	X	X	JM5368	1	VIN (Q), VIN (D)
4.8 12V	1975.01	1977.12	90	122	-	6		X	X	X	JM5368	1	VIN (T)





GMC USA												
<b>C1500</b>												
4.1 12V	1980.01	1980.12	82	112	-	6		X	X	JM5366	1	VIN (D); Exc. California
4.1 12V	1980.01	1980.12	82	112	-	6		X	X	JM5367	1	VIN (D); California
4.1 12V	1980.01	1980.12	93	126	-	6		X	X	JM5366	1	VIN (D) Exc. California
4.1 12V	1980.01	1980.12	93	126	-	6		X	X	JM5367	1	VIN (D); California
4.3	1996.01	1998.12	107	146	-	6		X	X	JM5385	1	VIN (W)
4.3	1996.01	1998.12	116	158	-	6		X	X	JM5385	1	VIN (W)
4.3	1996.01	1998.12	151	203	-	6		X	X	JM5385	1	VIN (W)
4.8 12V	1979.01	1980.12	86	117	-	6		X	X	JM5366	1	VIN (T)
5.0	1996.01	1999.12	97	132	-	8		X	X	JM5385	1	VIN (M)
5.0	1996.01	1999.12	131	178	-	8		X	X	JM5385	1	VIN (M)
5.7	1996.01	1999.12	90	122	-	8		X	X	JM5385	1	VIN (R)
5.7	1996.01	1999.12	149	203	-	8		X	X	JM5385	1	VIN (R)
5.7	1996.01	1999.12	193	258	-	8		X	X	JM5385	1	VIN (R)
<b>C2500</b>												
5.0	1996.01	1997.12	104	140	-	8		X	X	JM5385	1	VIN (M)
5.7	1996.01	1999.12	90	120	-	8		X	X	JM5385	1	VIN (R)
5.7	1996.01	2000.12	120	163	-	8		X	X	JM5385	1	VIN (R)
5.7	1996.01	2000.12	193	262	-	8		X	X	JM5385	1	VIN (R)
7.4	1996.01	2000.12	157	214	-	8		X	X	JM5385	1	VIN (J)
<b>C3500</b>												
5.7	1996.01	2000.12	123	167	-	8		X	X	JM5385	1	VIN (R)
7.4	1996.01	2000.12	157	214	-	8		X	X	JM5385	1	VIN (J)
8.1	2000.09	2001.12	254	345	-	8		X	X	JM5473	8	VIN (G)
<b>C4500</b>												
8.1 V8	2003.01	2009.12	-	-	496cid.	8		X	X	JM5473	8	
<b>C5500</b>												
8.1 V8	2003.01	2009.12	-	-	496cid.	8		X	X	JM5473	8	
<b>C6500</b>												
8.1 V8	2003.01	2009.12	-	-	496cid.	8		X	X	JM5473	8	
<b>C7500</b>												
8.1 V8	2003.01	2009.12	-	-	496cid.	8		X	X	JM5473	8	
<b>CANYON</b>												
2.9	2006.09	2011.12	138	188	-	4	-	-	-	JM5405	4	VIN (9)
2.9 4WD	2006.09	2011.12	138	188	-	4	-	-	-	JM5405	4	VIN (9)
3.7	2006.09	2011.12	181	246	-	5	-	-	-	JM5405	5	VIN (E)
3.7 4WD	2006.09	2011.12	181	246	-	5	-	-	-	JM5405	5	VIN (E)
5.3	2008.09	2011.12	224	300	-	8		X	X	JM5406	8	sys. Mitsubishi VIN (L), VIN (P)
5.3	2008.09	2011.12	224	300	-	8		X	X	JM5439	8	sys. Delphi VIN (L), VIN (P)
5.3 4WD	2008.09	2011.12	224	300	-	8		X	X	JM5406	8	sys. Mitsubishi VIN (L), VIN (P)
5.3 4WD	2008.09	2011.12	224	300	-	8		X	X	JM5439	8	sys. Delphi VIN (L), VIN (P)
<b>ENVOY</b>												
4.2	2006.09	2009.12	205	275	-	6	-	-	-	JM5405	6	VIN (E), VIN (S)
4.2 4WD	2006.09	2009.12	205	275	-	6	-	-	-	JM5405	6	VIN (E), VIN (S)
5.3	2002.09	2009.12	224	300	-	8		X	X	JM5406	8	sys. Mitsubishi VIN (P), VIN (M)
5.3	2002.09	2009.12	224	300	-	8		X	X	JM5439	8	sys. Delphi VIN (P), VIN (M)
5.3 4WD	2002.09	2009.12	224	300	-	8		X	X	JM5406	8	sys. Mitsubishi VIN (P), VIN (M)
5.3 4WD	2002.09	2009.12	224	300	-	8		X	X	JM5439	8	sys. Delphi VIN (P), VIN (M)
<b>JIMMY</b>												
4.3	1996.01	2001.12	116	158	-	6		X	X	JM5385	1	VIN (W)
4.3 AWD	1996.01	2001.12	116	158	-	6		X	X	JM5385	1	VIN (W)
4.3	2001.09	2004.12	142	190	-	6		X	X	JM5385	1	VIN (W)
4.3 AWD	2001.09	2004.12	142	190	-	6		X	X	JM5385	1	VIN (W)
4.3 AWD	2004.09	2005.12	142	190	-	6		X	X	JM5385	1	VIN (X)
<b>P3500</b>												
4.3	1996.01	1999.12	116	155	-	6		X	X	JM5385	1	VIN (W)
5.7	1996.01	1996.12	123	165	-	8		X	X	JM5385	1	VIN (R)
5.7	1996.01	1996.12	123	165	-	8		X	X	JM5219	1	VIN (K)
5.7	1996.01	1999.12	149	203	-	8		X	X	JM5385	1	VIN (R)
5.7	1996.01	1996.12	149	203	-	8		X	X	JM5219	1	VIN (K)



<b>GMC USA</b>											
<b>P3500</b>											
7.4	1996.01	1997.12	157	214	-	8	X	X	JM5219	1	VIN (N); EFI
7.4	1996.01	1999.12	157	214	-	8	X	X	JM5385	1	VIN (J); SFI
7.4	1996.01	1997.12	172	230	-	8	X	X	JM5219	1	VIN (N); EFI
7.4	1996.01	1999.12	172	230	-	8	X	X	JM5385	1	VIN (J); SFI
7.4	1998.01	1999.12	157	214	-	8	-	-	X	8	VIN (B); MFI
<b>SAVANA</b>											
4.3	2007.09	2011.12	146	195	-	6	X	X	JM5496	1	VIN (X)
4.3 AWD	2007.09	2011.12	146	195	-	6	X	X	JM5496	1	VIN (X)
4.8	2002.09	2006.12	205	279	-	8	X	X	JM5473	8	sys. Mitsubishi; VIN (V)
4.8	2002.09	2006.12	205	279	-	8	X	X	JM5442	8	sys. Delphi; VIN (V)
4.8 AWD	2002.09	2006.12	205	279	-	8	X	X	JM5473	8	sys. Mitsubishi; VIN (V)
4.8 AWD	2002.09	2006.12	205	279	-	8	X	X	JM5442	8	sys. Delphi; VIN (V)
4.8	2003.09	2007.12	213	290	-	8	X	X	JM5473	8	sys. Mitsubishi; VIN (V)
4.8	2003.09	2007.12	213	290	-	8	X	X	JM5442	8	sys. Delphi; VIN (V)
4.8	2007.09	2009.12	208	282	-	8	X	X	JM5406	8	sys. Mitsubishi; VIN (C)
4.8	2007.09	2009.12	208	282	-	8	X	X	JM5439	8	sys. Delphi; VIN (C)
4.8	2007.09	2009.12	213	290	-	8	X	X	JM5406	8	sys. Mitsubishi; VIN (C)
4.8	2007.09	2009.12	213	290	-	8	X	X	JM5439	8	sys. Delphi; VIN (C)
4.8 Flexfuel	2009.09	2011.12	208	282	-	8	X	X	JM5406	8	sys. Mitsubishi; VIN (A)
4.8 Flexfuel	2009.09	2011.12	208	282	-	8	X	X	JM5439	8	sys. Delphi; VIN (A)
5.3	2002.09	2006.12	213	290	-	8	X	X	JM5473	8	sys. Mitsubishi; VIN (T)
5.3	2002.09	2006.12	213	290	-	8	X	X	JM5442	8	sys. Delphi; VIN (T)
5.3 AWD	2002.09	2006.12	213	290	-	8	X	X	JM5473	8	sys. Mitsubishi; VIN (T)
5.3 AWD	2002.09	2006.12	213	290	-	8	X	X	JM5442	8	sys. Delphi; VIN (T)
5.3	2006.09	2007.12	220	300	-	8	X	X	JM5473	8	sys. Mitsubishi; VIN (Z)
5.3	2006.09	2007.12	220	300	-	8	X	X	JM5442	8	sys. Delphi; VIN (Z)
5.3 AWD	2006.09	2007.12	220	300	-	8	X	X	JM5473	8	sys. Mitsubishi; VIN (Z)
5.3 AWD	2006.09	2007.12	220	300	-	8	X	X	JM5442	8	sys. Delphi; VIN (Z)
5.3 Flexfuel	2007.09	2009.12	225	306	-	8	X	X	JM5406	8	sys. Mitsubishi; VIN (4)
5.3 Flexfuel	2007.09	2009.12	225	306	-	8	X	X	JM5439	8	sys. Delphi; VIN (4)
5.3 Flexfuel AWD	2007.09	2009.12	225	306	-	8	X	X	JM5406	8	sys. Mitsubishi; VIN (4)
5.3 Flexfuel AWD	2007.09	2009.12	225	306	-	8	X	X	JM5439	8	sys. Delphi; VIN (4)
5.3 Flexfuel	2009.09	2011.12	231	314	-	8	X	X	JM5406	8	sys. Mitsubishi; VIN (4)
5.3 Flexfuel	2009.09	2011.12	231	314	-	8	X	X	JM5439	8	sys. Delphi; VIN (4)
5.3 Flexfuel AWD	2009.09	2011.12	231	314	-	8	X	X	JM5406	8	sys. Mitsubishi; VIN (4)
5.3 Flexfuel AWD	2009.09	2011.12	231	314	-	8	X	X	JM5439	8	sys. Delphi; VIN (4)
6.0	2002.09	2006.12	224	305	-	8	X	X	JM5473	8	sys. Mitsubishi; VIN (U)
6.0	2002.09	2006.12	224	305	-	8	X	X	JM5442	8	sys. Delphi; VIN (U)
6.0 AWD	2002.09	2005.12	224	305	-	8	X	X	JM5473	8	sys. Mitsubishi; VIN (U)
6.0 AWD	2002.09	2005.12	224	305	-	8	X	X	JM5442	8	sys. Delphi; VIN (U)
6.0	2006.09	2007.12	243	330	-	8	X	X	JM5473	8	sys. Mitsubishi; VIN (U)
6.0	2006.09	2007.12	243	330	-	8	X	X	JM5442	8	sys. Delphi; VIN (U)
6.0	2007.09	2009.12	238	323	-	8	X	X	JM5406	8	sys. Mitsubishi; VIN (K)
6.0	2007.09	2009.12	238	323	-	8	X	X	JM5439	8	sys. Delphi; VIN (K)
6.0	2008.09	2012.12	242	329	-	8	X	X	JM5406	8	sys. Mitsubishi OE 12611424
6.0	2008.09	2012.12	242	329	-	8	X	X	JM5439	8	s. Delphi; OE 12573190
6.0 Flexfuel	2009.09	2011.12	241	328	-	8	X	X	JM5406	8	sys. Mitsubishi; VIN (G)
6.0 Flexfuel	2009.09	2011.12	241	328	-	8	X	X	JM5439	8	sys. Delphi; VIN (G)
6.0 FLEX	2009.09	2012.12	242	329	-	8	X	X	JM5406	8	sys. Mitsubishi OE 12611424
6.0 FLEX	2009.09	2012.12	242	329	-	8	X	X	JM5439	8	sys. Delphi OE 12573190
6.0 Flexfuel	2009.09	2011.12	242	329	-	8	X	X	JM5406	8	sys. Mitsubishi VIN (K), VIN (G)
6.0 Flexfuel	2009.09	2011.12	242	329	-	8	X	X	JM5439	8	sys. Delphi VIN (K), VIN (G)
8.1	2000.09	2002.12	254	345	-	8	X	X	JM5473	8	sys. Mitsubishi; VIN (G)
<b>SIERRA</b>											
4.3	2007.09	2012.12	145	195	-	6	X	X	JM5496	1	VIN (X)
4.3 4WD	2007.09	2012.12	145	195	-	6	X	X	JM5496	1	VIN (X)
4.8	1998.09	2005.12	190	258	-	8	X	X	JM5473	8	sys. Mitsubishi; VIN (V)
4.8	1998.09	2005.12	190	258	-	8	X	X	JM5442	8	sys. Delphi; VIN (V)
4.8 4WD	1998.09	2005.12	190	258	-	8	X	X	JM5473	8	sys. Mitsubishi; VIN (V)
4.8 4WD	1998.09	2005.12	190	258	-	8	X	X	JM5442	8	sys. Delphi; VIN (V)
4.8	1998.09	2005.12	209	284	-	8	X	X	JM5473	8	sys. Mitsubishi; VIN (V)
4.8	1998.09	2005.12	209	284	-	8	X	X	JM5442	8	sys. Delphi; VIN (V)
4.8 4WD	1998.09	2005.12	209	284	-	8	X	X	JM5473	8	sys. Mitsubishi; VIN (V)



													<b>GMC USA</b>	
<b>SIERRA</b>														
4.8 4WD	1998.09	2005.12	209	284	-	8		X	X	JM5442	8	sys. Delphi; VIN (V)		
4.8	2003.09	2005.12	205	279	-	8		X	X	JM5473	8	sys. Mitsubishi; VIN (V)		
4.8	2003.09	2005.12	205	279	-	8		X	X	JM5442	8	sys. Delphi; VIN (V)		
4.8 4WD	2003.09	2005.12	205	279	-	8		X	X	JM5473	8	sys. Mitsubishi; VIN (V)		
4.8 4WD	2003.09	2005.12	205	279	-	8		X	X	JM5442	8	sys. Delphi; VIN (V)		
4.8	2007.09	2007.12	220	299	-	8		X	X	JM5473	8	sys. Mitsubishi; VIN (V)		
4.8	2007.09	2007.12	220	299	-	8		X	X	JM5442	8	sys. Delphi; VIN (V)		
4.8	2007.09	2009.12	220	299	-	8		X	X	JM5406	8	sys. Mitsubishi; VIN (C)		
4.8	2007.09	2009.12	220	299	-	8		X	X	JM5439	8	sys. Delphi; VIN (C)		
4.8 4WD	2007.09	2007.12	220	299	-	8		X	X	JM5473	8	sys. Mitsubishi; VIN (V)		
4.8 4WD	2007.09	2007.12	220	299	-	8		X	X	JM5442	8	sys. Delphi; VIN (V)		
4.8 4WD	2007.09	2009.12	220	299	-	8		X	X	JM5406	8	sys. Mitsubishi; VIN (C)		
4.8 4WD	2007.09	2009.12	220	299	-	8		X	X	JM5439	8	sys. Delphi; VIN (C)		
4.8 FLEX	2009.09	-->	225	306	-	8		X	X	JM5406	8	sys. Mitsubishi; VIN (A)		
4.8 FLEX	2009.09	-->	225	306	-	8		X	X	JM5439	8	sys. Delphi; VIN (A)		
4.8 FLEX 4WD	2009.09	-->	225	306	-	8		X	X	JM5406	8	sys. Mitsubishi; VIN (A)		
4.8 FLEX 4WD	2009.09	-->	225	306	-	8		X	X	JM5439	8	sys. Delphi; VIN (A)		
5.3	2006.09	2007.12	235	320	-	8		X	X	JM5406	8	sys. Mitsubishi; Mexico		
5.3	2006.09	2007.12	235	320	-	8		X	X	JM5439	8	sys. Delphi; Mexico		
5.3 Flexfuel	2007.01	2007.12	224	305	-	8		X	X	JM5473	8	sys. Mitsubishi		
5.3 Flexfuel	2007.01	2007.12	224	305	-	8		X	X	JM5442	8	sys. Delphi		
5.3 Flexfuel	2007.01	2007.12	224	305	-	8		X	X	JM5406	8	sys. Mitsubishi		
5.3 Flexfuel	2007.01	2007.12	224	305	-	8		X	X	JM5439	8	sys. Delphi		
5.3 Flexfuel 4WD	2007.01	2007.12	224	300	-	8		X	X	JM5473	8	sys. Mitsubishi		
5.3 Flexfuel 4WD	2007.01	2007.12	224	300	-	8		X	X	JM5442	8	sys. Delphi		
5.3 Flexfuel 4WD	2007.01	2007.12	224	300	-	8		X	X	JM5406	8	sys. Mitsubishi		
5.3 Flexfuel 4WD	2007.01	2007.12	224	300	-	8		X	X	JM5439	8	sys. Delphi		
5.3	2007.09	2007.12	224	305	-	8		X	X	JM5473	8	sys. Mitsubishi		
5.3	2007.09	2007.12	224	305	-	8		X	X	JM5442	8	sys. Delphi		
5.3	2007.09	2009.12	224	305	-	8		X	X	JM5406	8	sys. Mitsubishi		
5.3	2007.09	2009.12	224	305	-	8		X	X	JM5439	8	sys. Delphi		
5.3	2007.09	2007.12	228	310	-	8		X	X	JM5473	8	sys. Mitsubishi		
5.3	2007.09	2007.12	228	310	-	8		X	X	JM5442	8	sys. Delphi		
5.3	2007.09	2009.12	228	310	-	8		X	X	JM5406	8	sys. Mitsubishi		
5.3	2007.09	2009.12	228	310	-	8		X	X	JM5439	8	sys. Delphi		
5.3 4WD	2007.09	2007.12	224	305	-	8		X	X	JM5473	8	sys. Mitsubishi		
5.3 4WD	2007.09	2007.12	224	305	-	8		X	X	JM5442	8	sys. Delphi		
5.3 4WD	2007.09	2009.12	224	305	-	8		X	X	JM5406	8	sys. Mitsubishi		
5.3 4WD	2007.09	2009.12	224	305	-	8		X	X	JM5439	8	sys. Delphi		
5.3 4WD	2007.09	2007.12	228	310	-	8		X	X	JM5473	8	sys. Mitsubishi		
5.3 4WD	2007.09	2007.12	228	310	-	8		X	X	JM5442	8	sys. Delphi		
5.3 4WD	2007.09	2009.12	228	310	-	8		X	X	JM5406	8	sys. Mitsubishi		
5.3 4WD	2007.09	2009.12	228	310	-	8		X	X	JM5439	8	sys. Delphi		
5.3 FLEX	2007.09	2007.12	228	310	-	8		X	X	JM5473	8	sys. Mitsubishi		
5.3 FLEX	2007.09	2007.12	228	310	-	8		X	X	JM5442	8	sys. Delphi		
5.3 FLEX	2007.09	2012.12	228	310	-	8		X	X	JM5406	8	sys. Mitsubishi		
5.3 FLEX	2007.09	2012.12	228	310	-	8		X	X	JM5439	8	sys. Delphi		
5.3 FLEX 4WD	2007.09	2007.12	228	310	-	8		X	X	JM5473	8	sys. Mitsubishi		
5.3 FLEX 4WD	2007.09	2007.12	228	310	-	8		X	X	JM5442	8	sys. Delphi		
5.3 FLEX 4WD	2007.09	2012.12	228	310	-	8		X	X	JM5406	8	sys. Mitsubishi		
5.3 FLEX 4WD	2007.09	2012.12	228	310	-	8		X	X	JM5439	8	sys. Delphi		
5.3 4WD	2008.09	2010.12	235	320	-	8		X	X	JM5406	8	sys. Mitsubishi; Mexico		
5.3 4WD	2008.09	2010.12	235	320	-	8		X	X	JM5439	8	sys. Delphi; Mexico		
6.0 4WD	2001.09	2007.12	243	330	-	8		X	X	JM5473	8	sys. Mitsubishi VIN (U), VIN (N)		
6.0 4WD	2001.09	2007.12	243	330	-	8		X	X	JM5442	8	sys. Delphi VIN (U), VIN (N)		
6.0 4x4	2003.09	2004.12	242	329	-	8		X	X	JM5473	8	sys. Mitsubishi; VIN (U)		
6.0 4x4	2003.09	2004.12	242	329	-	8		X	X	JM5442	8	sys. Delphi; VIN (U)		
6.0	2006.09	2010.12	265	360	-	8		X	X	JM5473	8	sys. Mitsubishi; VIN (U)		
6.0	2006.09	2010.12	265	360	-	8		X	X	JM5442	8	sys. Delphi; VIN (U)		
6.0	2006.09	2010.12	265	360	-	8		X	X	JM5406	8	sys. Mitsubishi VIN (K), VIN (G)		
6.0	2006.09	2010.12	265	360	-	8		X	X	JM5439	8	sys. Delphi VIN (K), VIN (G)		
6.0 4WD	2006.09	2010.12	265	360	-	8		X	X	JM5473	8	sys. Mitsubishi; VIN (U)		
6.0 4WD	2006.09	2010.12	265	360	-	8		X	X	JM5442	8	sys. Delphi; VIN (U)		



<b>GMC USA</b>												
<b>SIERRA</b>												
6.0 4WD	2006.09	2010.12	265	360	-	8		X	X	JM5406	8	sys. Mitsubishi VIN (K), VIN (G)
6.0 4WD	2006.09	2010.12	265	360	-	8		X	X	JM5439	8	sys. Delphi VIN (K), VIN (G)
6.0	2007.01	2007.12	272	370	-	8		X	X	JM5473	8	sys. Mitsubishi VIN (U), VIN (K)
6.0	2007.01	2007.12	272	370	-	8		X	X	JM5439	8	s.Delphi VIN (U) VIN (K)
6.0 4WD	2007.01	2007.12	272	370	-	8		X	X	JM5473	8	sys. Mitsubishi; VIN (U)
6.0 4WD	2007.01	2007.12	272	370	-	8		X	X	JM5442	8	sys. Delphi; VIN (U)
6.0 4WD	2007.01	2007.12	272	370	-	8		X	X	JM5406	8	sys. Mitsubishi; VIN (K)
6.0 4WD	2007.01	2007.12	272	370	-	8		X	X	JM5439	8	sys. Delphi; VIN (K)
6.0	2007.09	2009.12	273	371	-	8		X	X	JM5473	8	sys. Mitsubishi; VIN (N)
6.0	2007.09	2009.12	273	371	-	8		X	X	JM5442	8	sys. Delphi; VIN (N)
6.0	2007.09	2009.12	273	371	-	8		X	X	JM5406	8	sys. Mitsubishi VIN (Y), VIN (5)
6.0	2007.09	2009.12	273	371	-	8		X	X	JM5439	8	sys. Delphi VIN (Y), VIN (5)
6.0 AWD	2007.09	2009.12	273	371	-	8		X	X	JM5473	8	sys. Mitsubishi; VIN (N)
6.0 AWD	2007.09	2009.12	273	371	-	8		X	X	JM5442	8	sys. Delphi; VIN (N)
6.0 AWD	2007.09	2009.12	273	371	-	8		X	X	JM5406	8	sys. Mitsubishi VIN (Y), VIN (5)
6.0 AWD	2007.09	2009.12	273	371	-	8		X	X	JM5439	8	sys. Delphi VIN (Y), VIN (5)
6.0 FLEX 4WD	2008.09	2011.12	269	360	-	8		X	X	JM5406	8	sys. Mitsubishi; VIN (G)
6.0 FLEX 4WD	2008.09	2011.12	269	360	-	8		X	X	JM5439	8	sys. Delphi; VIN (G)
6.0 Hybrid	2008.09	2009.12	248	337	-	8		X	X	JM5406	8	sys. Mitsubishi; VIN (5)
6.0 Hybrid	2008.09	2009.12	248	337	-	8		X	X	JM5439	8	sys. Delphi; VIN (5)
6.0 Hybrid 4WD	2008.09	2009.12	248	337	-	8		X	X	JM5406	8	sys. Mitsubishi; VIN (5)
6.0 Hybrid 4WD	2008.09	2009.12	248	337	-	8		X	X	JM5439	8	sys. Delphi; VIN (5)
6.0	2009.09	-->	248	337	-	8		X	X	JM5406	8	sys. Mitsubishi; VIN (J)
6.0	2009.09	-->	248	337	-	8		X	X	JM5439	8	sys. Delphi; VIN (J)
6.0 4WD	2009.09	-->	248	337	-	8		X	X	JM5406	8	sys. Mitsubishi; VIN (J)
6.0 4WD	2009.09	-->	248	337	-	8		X	X	JM5439	8	sys. Delphi; VIN (J)
6.0 FLEX	2009.09	-->	269	360	-	8		X	X	JM5406	8	sys. Mitsubishi; VIN (G)
6.0 FLEX	2009.09	-->	269	360	-	8		X	X	JM5439	8	sys. Delphi; VIN (G)
6.2	2007.09	2008.12	301	409	-	8		X	X	JM5406	8	sys. Mitsubishi; VIN (8)
6.2	2007.09	2008.12	301	409	-	8		X	X	JM5439	8	sys. Delphi; VIN (8)
6.2 AWD	2007.09	2010.12	301	409	-	8		X	X	JM5406	8	sys. Mitsubishi; Mexico
6.2 AWD	2007.09	2010.12	301	409	-	8		X	X	JM5439	8	sys. Delphi; Mexico
6.2 AWD	2007.09	2008.12	301	409	-	8		X	X	JM5406	8	sys. Mitsubishi; VIN (8)
6.2 AWD	2007.09	2008.12	301	409	-	8		X	X	JM5439	8	sys. Delphi; VIN (8)
6.2 FLEX	2008.09	2012.12	301	409	-	8		X	X	JM5406	8	sys. Mitsubishi; VIN (2)
6.2 FLEX	2008.09	2012.12	301	409	-	8		X	X	JM5439	8	sys. Delphi; VIN (2)
6.2 FLEX 4WD	2008.09	2012.12	301	409	-	8		X	X	JM5406	8	sys. Mitsubishi; VIN (2)
6.2 FLEX 4WD	2008.09	2012.12	301	409	-	8		X	X	JM5439	8	sys. Delphi; VIN (2)
6.2 Flexfuel	2010.01	2010.12	301	409	-	8		X	X	JM5406	8	sys. Mitsubishi; VIN (2)
6.2 Flexfuel	2010.01	2010.12	301	409	-	8		X	X	JM5439	8	sys. Delphi; VIN (2)
6.2 Flexfuel 4WD	2010.01	2010.12	301	409	-	8		X	X	JM5406	8	sys. Mitsubishi; VIN (2)
6.2 Flexfuel 4WD	2010.01	2010.12	301	409	-	8		X	X	JM5439	8	sys. Delphi; VIN (2)
<b>SONOMA</b>												
2.2	1993.09	2003.12	88	120	-	4		X	X	JM5290	2	VIN (4), VIN (5), VIN (H)
2.2	1993.09	2003.12	89	121	-	4		X	X	JM5290	2	VIN (4), VIN (5), VIN (H)
2.2 4WD	1993.09	2003.12	88	120	-	4		X	X	JM5290	2	VIN (4), VIN (5), VIN (H)
2.2 4WD	1993.09	2003.12	89	121	-	4		X	X	JM5290	2	VIN (4), VIN (5), VIN (H)
2.2 Flexfuel	2000.09	2002.09	90	122	-	4		X	X	JM5290	2	VIN (5)
2.2 Flexfuel 4WD	2000.09	2002.09	90	122	-	4		X	X	JM5290	2	VIN (5)
2.2	2002.09	2003.12	90	122	-	4		X	X	JM5290	2	VIN (H)
2.2 4WD	2002.09	2003.12	90	122	-	4		X	X	JM5290	2	VIN (H)
<b>TERRAIN</b>												
2.4	2010.09	2010.12	136	185	-	4	-	-	-	JM5609	4	
2.4 AWD	2010.09	2010.12	136	185	-	4	-	-	-	JM5609	4	
2.4 Flexfuel	2011.09	-->	136	185	-	4	-	-	-	JM5609	4	
2.4 Flexfuel AWD	2011.09	-->	136	185	-	4	-	-	-	JM5609	4	
<b>TOPKICK</b>												
8.1 V8	2004.01	2009.12	-	-	-	8		X	X	JM5473	8	
<b>YUKON</b>												
4.8	2000.09	2004.12	205	279	-	8		X	X	JM5473	8	sys. Mitsubishi; VIN (V)
4.8	2000.09	2004.12	205	279	-	8		X	X	JM5442	8	sys. Delphi; VIN (V)
4.8 AWD	2000.09	2004.12	205	279	-	8		X	X	JM5473	8	sys. Mitsubishi; VIN (V)



												<b>GMC USA</b>	
<b>YUKON</b>													
4.8 AWD	2000.09	2004.12	205	279	-	8		X	X	JM5442	8	sys. Delphi; VIN (V)	
4.8	2007.09	2009.12	220	299	-	8		X	X	JM5406	8	sys. Mitsubishi; VIN (C)	
4.8	2007.09	2009.12	220	299	-	8		X	X	JM5439	8	sys. Delphi; VIN (C)	
4.8 4WD	2007.09	2009.12	220	299	-	8		X	X	JM5406	8	sys. Mitsubishi; VIN (C)	
4.8 4WD	2007.09	2009.12	220	299	-	8		X	X	JM5439	8	sys. Delphi; VIN (C)	
5.3	1999.09	2005.12	213	290	-	8		X	X	JM5473	8	sys. Mitsubishi; VIN (T)	
5.3	1999.09	2005.12	213	290	-	8		X	X	JM5442	8	sys. Delphi; VIN (T)	
5.3 4WD	1999.09	2005.12	213	290	-	8		X	X	JM5473	8	sys. Mitsubishi; VIN (T)	
5.3 4WD	1999.09	2005.12	213	290	-	8		X	X	JM5442	8	sys. Delphi; VIN (T)	
5.3	2000.09	2004.12	213	290	-	8		X	X	JM5473	8	sys. Mitsubishi; VIN (T)	
5.3	2000.09	2004.12	213	290	-	8		X	X	JM5442	8	sys. Delphi; VIN (T)	
5.3 Flexfuel	2001.09	2004.12	213	290	-	8		X	X	JM5473	8	sys. Mitsubishi VIN (T), VIN (Z)	
5.3 Flexfuel	2001.09	2004.12	213	290	-	8		X	X	JM5442	8	sys. Delphi VIN (T), VIN (Z)	
5.3 Flexfuel 4WD	2001.09	2004.12	213	290	-	8		X	X	JM5473	8	sys. Mitsubishi VIN (T), VIN (Z)	
5.3 Flexfuel 4WD	2001.09	2004.12	213	290	-	8		X	X	JM5442	8	sys. Delphi VIN (T), VIN (Z)	
5.3 Flexfuel 4WD	2004.09	2007.12	220	299	-	8		X	X	JM5473	8	sys. Mitsubishi; VIN (Z)	
5.3 Flexfuel 4WD	2004.09	2007.12	220	299	-	8		X	X	JM5442	8	sys. Delphi; VIN (Z)	
5.3 Flexfuel	2005.09	2007.12	220	299	-	8		X	X	JM5473	8	sys. Mitsubishi; VIN (Z)	
5.3 Flexfuel	2005.09	2007.12	220	299	-	8		X	X	JM5442	8	sys. Delphi; VIN (Z)	
5.3 Flexfuel	2005.09	2007.12	220	299	-	8		X	X	JM5406	8	sys. Delphi VIN (0), VIN (3), VIN (J)	
5.3 Flexfuel	2005.09	2007.12	220	299	-	8		X	X	JM5439	8	sys. Mitsubishi VIN (0), VIN (3), VIN (J)	
5.3 Flexfuel 4WD	2005.09	2007.12	220	299	-	8		X	X	JM5406	8	sys. Delphi VIN (0), VIN (3), VIN (J)	
5.3 Flexfuel 4WD	2005.09	2007.12	220	299	-	8		X	X	JM5439	8	sys. Mitsubishi VIN (0), VIN (3), VIN (J)	
5.3	2006.09	2010.12	239	325	-	8		X	X	JM5406	8	sys. Mitsubishi VIN (0), VIN (3), VIN (J)	
5.3	2006.09	2010.12	239	325	-	8		X	X	JM5439	8	sys. Delphi VIN (0), VIN (3), VIN (J)	
5.3 4WD	2006.09	2010.12	239	325	-	8		X	X	JM5406	8	sys. Mitsubishi VIN (0), VIN (3), VIN (J)	
5.3 4WD	2006.09	2010.12	239	325	-	8		X	X	JM5439	8	sys. Delphi VIN (0), VIN (3), VIN (J)	
5.3 FLEX	2007.09	2012.12	239	325	-	8		X	X	JM5406	8	sys. Mitsubishi VIN (0), VIN (3), VIN (J)	
5.3 FLEX	2007.09	2012.12	239	325	-	8		X	X	JM5439	8	sys. Delphi VIN (0), VIN (3), VIN (J)	
5.3 FLEX 4WD	2007.09	2012.12	239	325	-	8		X	X	JM5406	8	sys. Mitsubishi VIN (0), VIN (3), VIN (J)	
5.3 FLEX 4WD	2007.09	2012.12	239	325	-	8		X	X	JM5439	8	sys. Delphi VIN (0), VIN (3), VIN (J)	
6.0	1999.09	2007.12	224	305	-	8		X	X	JM5473	8	sys. Mitsubishi; VIN (U)	
6.0	1999.09	2007.12	224	305	-	8		X	X	JM5442	8	sys. Delphi; VIN (U)	
6.0 4WD	1999.09	2007.12	224	305	-	8		X	X	JM5473	8	sys. Mitsubishi; VIN (U)	
6.0 4WD	1999.09	2007.12	224	305	-	8		X	X	JM5442	8	sys. Delphi; VIN (U)	
6.0	2000.09	2003.12	242	329	-	8		X	X	JM5473	8	sys. Mitsubishi; VIN (U)	
6.0	2000.09	2003.12	242	329	-	8		X	X	JM5442	8	sys. Delphi; VIN (U)	
6.0 AWD	2000.09	2006.12	243	330	-	8		X	X	JM5473	8	sys. Mitsubishi; VIN (U)	
6.0 AWD	2000.09	2006.12	243	330	-	8		X	X	JM5442	8	sys. Delphi; VIN (U)	
6.0	2007.09	2009.12	265	360	-	8		X	X	JM5406	8	sys. Mitsubishi; VIN (K)	
6.0	2007.09	2009.12	265	360	-	8		X	X	JM5439	8	sys. Delphi; VIN (K)	
6.0	2007.09	2009.12	273	371	-	8		X	X	JM5406	8	sys. Mitsubishi; VIN (Y)	
6.0	2007.09	2009.12	273	371	-	8		X	X	JM5439	8	sys. Delphi; VIN (Y)	
6.0 4WD	2007.09	2009.12	265	360	-	8		X	X	JM5406	8	sys. Mitsubishi; VIN (K)	
6.0 4WD	2007.09	2009.12	265	360	-	8		X	X	JM5439	8	sys. Delphi; VIN (K)	
6.0 4WD	2007.09	2009.12	273	371	-	8		X	X	JM5406	8	sys. Mitsubishi; VIN (Y)	
6.0 4WD	2007.09	2009.12	273	371	-	8		X	X	JM5439	8	sys. Delphi; VIN (Y)	
6.0 Hybrid	2007.09	2009.09	248	337	-	8		X	X	JM5406	8	sys. Mitsubishi; VIN (5)	
6.0 Hybrid	2007.09	2009.09	248	337	-	8		X	X	JM5439	8	sys. Delphi; VIN (5)	
6.0	2009.09	-->	248	337	-	8		X	X	JM5406	8	sys. Mitsubishi; VIN (J)	
6.0	2009.09	-->	248	337	-	8		X	X	JM5439	8	sys. Delphi; VIN (J)	
6.0 4WD	2009.09	-->	248	337	-	8		X	X	JM5406	8	sys. Mitsubishi; VIN (J)	
6.0 4WD	2009.09	-->	248	337	-	8		X	X	JM5439	8	sys. Delphi; VIN (J)	
6.0 FLEX	2009.09	-->	263	358	-	8		X	X	JM5406	8	sys. Mitsubishi; VIN (G)	
6.0 FLEX	2009.09	-->	265	360	-	8		X	X	JM5439	8	sys. Delphi; VIN (G)	
6.0 FLEX 4WD	2009.09	-->	263	358	-	8		X	X	JM5406	8	sys. Mitsubishi; VIN (G)	



## GMC USA

YUKON												
6.0 FLEX 4WD	2009.09	-->	265	360	-	8		X	X	JM5439	8	sys. Delphi; VIN (G)
6.2 4WD	2006.09	2009.12	284	386	-	8		X	X	JM5406	8	sys. Mitsubishi; VIN (8)
6.2 4WD	2006.09	2009.12	284	386	-	8		X	X	JM5439	8	sys. Delphi; VIN (8)
6.2	2008.09	2009.12	284	386	-	8		X	X	JM5406	8	sys. Mitsubishi; VIN (8)
6.2	2008.09	2009.12	284	386	-	8		X	X	JM5439	8	sys. Delphi; VIN (8)
6.2 FLEX	2008.09	2012.12	301	409	-	8		X	X	JM5406	8	sys. Mitsubishi; VIN (2), VIN (F)
6.2 FLEX	2008.09	2012.12	301	409	-	8		X	X	JM5439	8	sys. Delphi; VIN (2), VIN (F)
6.2 FLEX AWD	2008.09	2012.12	301	409	-	8		X	X	JM5406	8	sys. Mitsubishi; VIN (2), VIN (F)
6.2 FLEX AWD	2008.09	2012.12	301	409	-	8		X	X	JM5439	8	sys. Delphi; VIN (2), VIN (F)
6.2 FLEX AWD	2008.09	2012.12	284	386	-	8		X	X	JM5406	8	sys. Mitsubishi; VIN (8), VIN (F)
6.2 FLEX AWD	2008.09	2012.12	284	386	-	8		X	X	JM5439	8	sys. Delphi; VIN (8), VIN (F)
8.1	2000.09	2006.12	239	325	-	8		X	X	JM5473	8	VIN (G)
8.1 4WD	2000.09	2006.12	239	325	-	8		X	X	JM5473	8	VIN (G)

## HONDA USA

ACCORD												
1.6	1975.09	1978.12	59	80	-	4	-	-	-	JM5455	1	+ resistor
2.2 16V	1990.01	1991.12	93	126	F22A1	4	1/4	JP192	JPE192	X	-	
2.2 16V	1990.01	1991.12	97	132	F22A4	4		X	X	JM5156	1	
2.2 16V	1990.01	1991.12	104	141	F22A6	4		X	X	JM5156	1	
2.2 SOHC	1990.01	1993.12	93	126	F22A1	4		X	X	JM5156	1	
2.2 SOHC	1990.01	1991.12	97	132	F22A4	4		X	X	JM5156	1	
2.2 SOHC	1991.01	1993.12	104	141	F22A6	4		X	X	JM5156	1	
2.2 L4 MFI SOHC	1992.01	1997.12	93	126	F22A1	4		X	X	JM5194	1	
2.2 L4 MFI SOHC	1992.01	1997.12	97	132	F22B2	4		X	X	JM5194	1	
2.2 L4 MFI SOHC	1992.01	1997.12	104	141	F22A6	4		X	X	JM5194	1	
2.2 L4 MFI SOHC	1993.01	1993.12	93	126	F22A1	4		X	X	JM5194	1	
2.2 L4 MFI SOHC	1993.01	1993.12	104	141	F22A6	4		X	X	JM5194	1	
2.2 L4 MFI SOHC	1996.01	1996.12	97	132	F22B2	4		X	X	JM5194	1	
2.2 L4 FI SOHC	1997.01	1997.12	107	146	F22B1	4		X	X	JM5194	1	
2.3 16V	1998.01	1998.12	115	156	F23A5	4		X	X	JM5156	1	
2.3 SOHC	1998.01	2002.12	115	156	F23A5	4		X	X	JM5156	1	
2.3 SOHC	1998.01	2002.12	-	-	F23A1	4		X	X	JM5156	1	
2.3 SOHC	1998.01	2002.12	-	-	F23A4	4		X	X	JM5156	1	
2.4	2002.09	2005.12	119	162	K24A4	4	-	-	-	JM5383	4	
2.4	2006.09	2006.12	122	166	K24A8	4	-	-	-	JM5383	4	
2.4	2006.09	2006.12	124	169	K24A8	4	-	-	-	JM5383	4	
2.7 24V	1995.01	1997.12	127	173	-	6		X	X	JM5195	1	
2.7 24V	1997.01	1997.12	127	173	-	6		X	X	JM5195	1	
2.7 V6 MFI SOHC	1995.01	1997.12	-	-	C27A4	6		X	X	JM5195	1	

CIVIC												
1.2	1975.09	1979.12	41	56	-	4		X	X	JM5455	1	+ resistor
1.5	1974.09	1979.12	43	58	-	4		X	X	JM5455	1	+ resistor
1.5 16V	1992.01	1995.12	46	63	D15B7	4		X	X	JM5156	1	
1.5 SOHC	1992.01	1995.12	52	71	D15B8	4		X	X	JM5156	1	
1.5 16V	1992.01	1995.12	52	71	D15B7	4		X	X	JM5156	1	
1.5 16V	1992.01	1995.12	69	94	D15Z1	4		X	X	JM5156	1	
1.5 16V	1992.01	1995.12	69	94	D15B7	4		X	X	JM5156	1	
1.5 16V	1992.01	1995.12	74	101	D15Z1	4		X	X	JM5156	1	
1.5 16V	1993.01	1995.12	76	103	D15B7	4		X	X	JM5156	1	
1.5 16V	1993.01	1995.12	88	120	D15Z1	4		X	X	JM5156	1	
1.6 SOHC	1992.01	1995.12	92	125	D16Z6	4		X	X	JM5156	1	
1.6 16V	1994.01	1997.12	119	160	B16A3	4		X	X	JM5156	1	
1.6 16V	1996.01	2000.12	77	105	D16Y7	4		X	X	JM5156	1	
1.6 16V	1996.01	2000.12	92	125	D16Y8	4		X	X	JM5156	1	TEC (screw terminals)
1.6 16V	1996.01	2000.12	92	125	D16Y8	4		X	X	JM5174	1	HITACHI (spade terminals)
1.6 16V	1996.01	2000.12	84	114	D16Y5	4		X	X	JM5174	1	
1.6 16V	1996.01	1997.12	119	160	B16A2	4		X	X	JM5156	1	
1.6 SOHC	1996.01	2000.12	84	114	D16Y5	4		X	X	JM5156	1	



## HONDA USA

CIVIC											
1.6 SOHC	1998.01	2000.12	-	-	D16B5	4		X	X	JM5156	1
1.6 SOHC CNG	1998.01	2000.12	84	114	D16Y5	4		X	X	JM5174	1
1.6 SOHC CNG	1998.01	2000.12	-	-	D16B5	4		X	X	JM5156	1
1.6 16V	1999.01	2000.12	119	160	B16A2	4		X	X	JM5156	1
1.7 SOHC	2001.01	2005.12	95	129	D17A1	4		X	X	JM5016	4
1.7 SOHC	2001.01	2005.12	85	116	D17A6	4		X	X	JM5016	4
1.7 SOHC	2001.01	2005.12	92	125	D17A2	4		X	X	JM5016	4
1.7 SOHC	2001.01	2005.12	92	125	D17A6	4		X	X	JM5016	4
1.7 SOHC CNG	2001.01	2005.12	75	101	D17A7	4		X	X	JM5016	4
2.0 L4 DOHC	2002.01	2005.12	118	160	K20A3	4	-	-	-	JM5383	4
2.0 Si	2005.09	2006.12	147	200	K20Z3	4	-	-	-	JM5383	4
2.0	2006.09	2011.12	147	200	K20Z3	4	-	-	-	JM5383	4
CR-V											
2.0	1997.01	2001.12	94	128	B20B4	4		X	X	JM5156	1 Dist. TD74U
2.0	1999.01	2001.12	110	147	B20Z2	4		X	X	JM5156	1
2.4	2002.01	2006.12	116	158	K24A1	4	-	-	-	JM5383	4
2.4 4WD	2006.09	2009.12	124	166	K24A1	4		-	-	JM5383	4
2.4 4WD	2011.09	-->	138	188	-	4		X	X	JM5423	4 OE 30520-R40-007
CR-Z											
1.5 Hybrid	2010.09	-->	91	122	LEA1	4		-	-	JM5605	4 OE 30520-RB0-003
ELEMENT											
2.4	2003.09	2006.12	116	158	K24A4	4	-	-	-	JM5383	4
2.4	2007.09	2007.12	116	158	K24A8	4	-	-	-	JM5383	4
2.4	2007.09	2011.12	124	166	K24A8	4	-	-	-	JM5383	4
FIT											
1.5 16V	2007.01	2008.12	81	110	-	4	-	-	-	JM5343	4
1.5	2008.09	2011.12	87	117	-	4	-	-	-	JM5605	4 OE 30520-RB0-003
INSIGHT											
1.0	1999.09	2006.12	54	73	ECA1	3	-	-	-	JM5604	3 OE 30520-PHM-003
PASSPORT											
2.6 V8	1994.01	1996.12	90	122	4ZE1	4		X	X	JM5358	1
3.2 24V	1994.01	1995.12	131	178	6VD1	6	-/6	JP132	JPE132	JM5290	3
3.2 24V	1996.01	1997.12	131	178	6VD1	6	-	-	-	X	6
PILOT											
3.5 4WD	2002.09	2004.12	179	243	J35A4	6	-	-	-	JM5383	6 Metal hold down bracket
3.5 4WD	2002.09	2004.12	179	243	J35A4	6	-	-	-	JM5016	6 Molded plastic hold down bracket
3.5 4WD	2004.09	2005.12	182	247	J35A6	6	-	-	-	JM5016	6
PRELUDE											
1.8 8V	1983.01	1986.12	80	108	-	4		X	X	JM5192	1
2.0 12V	1985.01	1987.12	82	112	-	4		X	X	JM5192	1
2.2 L4 MFI SOHC	1992.01	1996.12	96	131	F22A1	4		X	X	JM5194	1
2.2 L4 MFI SOHC	1993.01	1996.12	140	187	H22A1	4		X	X	JM5194	1
2.2 L4 MFI DOHC	1997.01	2001.12	147	197	H22A4	4		X	X	JM5194	1
2.3 L4 MFI DOHC	1992.01	1996.12	119	160	H23A1	4		X	X	JM5194	1
S2000											
2.2	2004.09	2005.12	177	241	F22C1	4	-	-	-	JM5383	4

## HUDSON

HORNET											
5.0	1951.01	1957.12	119	162	R6	6	1/6	AM102	AMU102	X	-

## HUMMER

H2											
6.0 4x4	2002.09	2004.12	232	315	LQ4	8		X	X	JM5442	8 sys. Delphi; VIN (U)
6.0 4x4	2002.09	2004.12	232	315	LQ4	8		X	X	JM5473	8 sys. Mitsubishi; VIN (U)
6.0	2004.09	2006.12	237	322	LQ4	8		X	X	JM5473	8 sys. Mitsubishi; VIN (U)
6.0	2004.09	2006.12	237	322	LQ4	8		X	X	JM5442	8 sys. Delphi; VIN (U)
6.0	2007.01	2007.12	237	322	LQ4	8		X	X	JM5406	8 sys. Mitsubishi; VIN (U)
6.0	2007.01	2007.12	237	322	LQ4	8		X	X	JM5439	8 sys. Delphi; VIN (U)
H3											
3.5	2006.01	2006.12	162	220	L52	5	-	-	-	JM5430	5
3.7 4x4	2006.09	2010.12	180	245	LLR	5	-	-	-	JM5405	5 VIN (E)
5.3 V8	2008.10	-->	224	305	LH8	8		X	X	JM5406	8 sys. Mitsubishi
5.3 V8	2008.10	-->	224	305	LH8	8		X	X	JM5439	8 sys. Delphi



## HUMMER USA

H2												
6.0 4WD	2007.01	2007.12	236	321	-	8		X	X	JM5473	8	sys. Mitsubishi; VIN (U)
6.0 4WD	2007.01	2007.12	236	321	-	8		X	X	JM5442	8	sys. Delphi; VIN (U)
6.0 4WD	2007.01	2007.12	236	321	-	8		X	X	JM5406	8	sys. Mitsubishi; VIN (U)
6.0 4WD	2007.01	2007.12	236	321	-	8		X	X	JM5439	8	sys. Delphi; VIN (U)
6.0 4WD	2007.01	2007.12	243	330	-	8		X	X	JM5473	8	sys. Mitsubishi; VIN (U)
6.0 4WD	2007.01	2007.12	243	330	-	8		X	X	JM5442	8	sys. Delphi; VIN (U)
6.0 4WD	2007.01	2007.12	243	330	-	8		X	X	JM5406	8	sys. Mitsubishi; VIN (U)
6.0 4WD	2007.01	2007.12	243	330	-	8		X	X	JM5439	8	sys. Delphi; VIN (U)
6.2 4WD	2007.09	2008.12	293	398	-	8		X	X	JM5406	8	sys. Mitsubishi; VIN (8)
6.2 4WD	2007.09	2008.12	293	398	-	8		X	X	JM5439	8	sys. Delphi; VIN (8)
6.2 FLEX 4WD	2008.09	2009.12	293	398	-	8		X	X	JM5406	8	sys. Mitsubishi; VIN (2)
6.2 FLEX 4WD	2008.09	2009.12	293	398	-	8		X	X	JM5439	8	sys. Delphi; VIN (2)
H3												
3.7 X	2008.09	2010.12	178	242	-	5	-	-	-	JM5405	5	VIN (E)
3.7 X	2006.09	2007.12	181	246	-	5	-	-	-	JM5405	5	VIN (E)
5.3 4WD	2007.09	2009.12	224	305	-	8		X	X	JM5406	8	sys. Mitsubishi; VIN (L)
5.3 4WD	2007.09	2009.12	224	305	-	8		X	X	JM5439	8	sys. Delphi; VIN (L)
5.3 X	2007.09	2010.12	224	305	-	8		X	X	JM5406	8	sys. Mitsubishi VIN (L), VIN (P)
5.3 X	2007.09	2010.12	224	305	-	8		X	X	JM5439	8	sys. Delphi VIN (L), VIN (P)
5.3 Flexfuel 4WD	2009.09	2010.12	224	305	-	8		X	X	JM5406	8	sys. Mitsubishi; VIN (L)
5.3 Flexfuel 4WD	2009.09	2010.12	224	305	-	8		X	X	JM5439	8	sys. Delphi; VIN (L)
H3T												
3.7 4WD	2008.09	2010.12	181	246	-	5		-	-	JM5405	5	VIN (E)
5.3 4WD	2008.09	2009.12	224	305	-	8		X	X	JM5406	8	sys. Mitsubishi; VIN (L)
5.3 4WD	2008.09	2009.12	224	305	-	8		X	X	JM5439	8	sys. Delphi; VIN (L)
5.3 FLEX 4WD	2009.09	-->	224	305	-	8		X	X	JM5406	8	sys. Mitsubishi; VIN (P)
5.3 FLEX 4WD	2009.09	-->	224	305	-	8		X	X	JM5439	8	sys. Delphi; VIN (P)

## INFINITI USA

EX35												
3.5	2007.09	2011.12	221	300	VQ35HR	6	-	-	-	JM5484	6	
3.5 AWD	2007.09	2011.12	221	300	VQ35HR	6	-	-	-	JM5484	6	
FX35												
3.5	2002.09	2006.12	209	284	VQ35DE	6	-	-	-	JM5417	6	
3.5 AWD	2002.09	2006.12	209	284	VQ35DE	6	-	-	-	JM5417	6	
3.5	2006.09	2008.12	209	280	VQ35DE	6		X	X	JM5417	6	
3.5 AWD	2006.09	2008.12	209	280	VQ35DE	6		X	X	JM5417	6	
3.5	2008.09	2011.12	226	303	VQ35HR	6	-	-	-	JM5484	6	
3.5 AWD	2008.09	2011.12	226	303	VQ35HR	6	-	-	-	JM5484	6	
FX45												
4.5 AWD	2002.09	2005.12	235	320	VQ45DE	8	-	-	-	JM5497	8	wo / coil boot OE 22433-AR215
4.5 AWD	2002.09	2005.12	235	320	VQ45DE	8	-	-	-	JM5392	8	w / coil boot OE 22448-AR215
4.5 AWD	2005.09	2008.12	239	325	VQ45DE	8	-	-	-	JM5497	8	wo / coil boot OE 22433-AR215
4.5 AWD	2005.09	2008.12	239	325	VQ45DE	8	-	-	-	JM5392	8	w / coil boot OE 22448-AR215
FX50												
5.0 4x4	2009.01	2010.12	291	395	VQ50VE	8	-	-	-	JM5372	6	1-2-3-4-5-6 cyl.
5.0 4x4	2009.01	2010.12	291	395	VQ50VE	8	-	-	-	X	2	7-8 cyl.
G25												
2.5	2010.09	2011.12	162	218	-	6	-	-	-	JM5484	6	
2.5 X (4x4)	2010.09	2011.12	162	218	-	6	-	-	-	JM5484	6	
G35												
3.5	2002.09	2006.12	194	264	VQ35DE	6	-	-	-	JM5417	6	
3.5	2007.09	2008.12	228	306	VQ35HR	6	-	-	-	JM5484	6	
3.5 X (4x4)	2007.09	2008.12	228	306	VQ35HR	6	-	-	-	JM5484	6	
I30												
3.0 V6 DOHC	1995.01	1998.12	-	-	VQ30DE	6	-	-	-	JM5050	3	left coil; sys. Hanshin
3.0 V6 DOHC	1995.01	1998.12	-	-	VQ30DE	6	-	-	-	JM5051	3	JM1186; right coil sys. Hansin
3.0 V6 DOHC	1995.01	1998.12	-	-	VQ30DE	6	-	-	-	JM5450	3	left coil; sys. Mitsubishi
3.0 V6 DOHC	1995.01	1998.12	-	-	VQ30DE	6	-	-	-	JM5451	3	right coil sys. Mitsubishi
3.0 T	1995.09	1999.12	142	193	VG30DE	6	-	-	-	JM5050	3	left coil; sys. Hanshin





											<b>INFINITI USA</b>	
<b>I30</b>												
3.0 T	1995.09	1999.12	142	193	VG30DE	6	-	-	-	JM5051	3	JM1186; right coil sys. Hanshin
3.0 T	1995.09	1999.12	142	193	VG30DE	6	-	-	-	JM5450	3	left coil; sys. Mitsubishi
3.0 T	1995.09	1999.12	142	193	VG30DE	6	-	-	-	JM5451	3	right coil sys. Mitsubishi
3.0 T	2000.01	2001.12	142	193	VG30DE	6	-	-	-	JM5133	3	JM1187; left coil
3.0 T	2000.01	2001.12	142	193	VG30DE	6	-	-	-	JM5132	3	JM1186; right coil
3.0 V6 DOHC	2000.01	2001.12	-	-	VQ30DE	6	-	-	-	JM5133	3	JM1187; left coil
3.0 V6 DOHC	2000.01	2001.12	-	-	VQ30DE	6	-	-	-	JM5132	3	JM1186; right coil
<b>I35</b>												
3.5 24V	2002.01	2004.12	190	258		6	-	-	-	JM5331	6	
<b>M35</b>												
3.5	2005.09	2008.12	209	284	VQ35DE	6	-	-	-	JM5417	6	
3.5 X (4x4)	2005.09	2008.12	209	284	VQ35DE	6	-	-	-	JM5417	6	
3.5	2008.09	2010.12	226	303	VQ35HR	6	-	-	-	JM5484	6	
3.5 X (4x4)	2008.09	2010.12	226	303	VQ35HR	6	-	-	-	JM5484	6	
3.5 Hybrid	2011.09	2012.12	269	360	VQ35HR	6		X	X	JM5484	6	
<b>M45</b>												
4.5	2002.09	2004.12	254	345	VK45DE	8	-	-	-	JM5497	8	wo / coil boot OE 22433-AR215
4.5	2002.09	2004.12	254	345	VK45DE	8	-	-	-	JM5392	8	w / coil boot OE 22448-AR215
4.5	2005.09	2008.12	250	340	VK45DE	8	-	-	-	JM5497	8	wo / coil boot OE 22433-AR215
4.5	2005.09	2008.12	250	340	VK45DE	8	-	-	-	JM5392	8	w / coil boot OE 22448-AR215
4.5	2008.09	2010.12	243	325	VK45DE	8	-	-	-	JM5497	8	wo / coil boot OE 22433-AR215
4.5	2008.09	2010.12	243	325	VK45DE	8	-	-	-	JM5392	8	w / coil boot OE 22448-AR215
<b>Q45</b>												
4.5 i	1990.01	1997.01	207	282	VH45DE	8	-	-	-	X	2	1 & 2 cyl.
4.5 i	1990.01	1997.01	207	282	VH45DE	8	-	-	-	X	6	JM1188; 3-4-5-6-7-8 cyl.
4.5	2001.02	2006.12	-	-	VK45DE	8		X	X	JM5497	8	wo / coil boot OE 22433-AR215
4.5	2001.02	2006.12	-	-	VK45DE	8		X	X	JM5392	8	w / coil boot OE 22448-AR215
<b>QX</b>												
4.1	1996.09	2001.12	199	271	VH41DE	8		X	X	JM5627	8	
5.6 4WD	2006.09	2009.12	239	320	VK56DE	8		X	X	JM5485	8	
5.6	2009.09	-->	239	320	VK56DE	8	-	-	-	JM5485	8	
<b>QX4</b>												
3.3 12V AWD	1997.01	1997.12	125	170	VG33E	6		X	X	JM5319	1	
3.3 12V AWD	1997.01	2000.12	125	170	VG33E	6		X	X	JM5319	1	
3.5 24V	2001.07	2003.12	179	243	VQ35DE	6	-	-	-	JM5331	6	
3.5 24V AWD	2001.07	2003.12	179	243	VQ35DE	6	-	-	-	JM5331	6	
<b>QX56</b>												
5.6	2003.09	2004.12	235	320	-	8	-	-	-	JM5424	8	
5.6 4WD	2003.09	2004.12	235	320	-	8	-	-	-	JM5424	8	
5.6	2004.09	2006.12	235	320	VK56DE	8	-	-	-	JM5424	8	
5.6 4WD	2004.09	2006.12	235	320	VK56DE	8	-	-	-	JM5424	8	
											<b>ISUZU USA</b>	
<b>AMIGO</b>												
2.2	1997.09	2000.12	96	131	-	4		X	X	JM5038	1	VIN (D)
2.2	1997.09	2000.12	96	131	-	4		X	X	JM5038	1	VIN (D)
2.3 8V	1989.01	1993.12	72	98	-	4		X	X	JM5358	1	VIN (L)
2.3 8V AWD	1989.01	1993.12	72	98	-	4		X	X	JM5358	1	VIN (L)
2.6 8V	1989.01	1994.12	90	122	-	4		X	X	JM5358	1	VIN (E)
2.6 8V AWD	1989.01	1994.12	90	122	-	4		X	X	JM5358	1	VIN (E)
<b>ASCENDER</b>												
5.3 4WD	2002.09	2004.12	224	300	-	8		X	X	JM5473	8	sys. Mitsubishi VIN (P)
5.3 4WD	2002.09	2004.12	224	300	-	8		X	X	JM5442	8	sys. Delphi; VIN (P)
5.3	2003.09	2004.12	224	300	-	8		X	X	JM5473	8	sys. Mitsubishi; VIN (P)
5.3	2003.09	2004.12	224	300	-	8		X	X	JM5442	8	sys. Delphi; VIN (P)
5.3	2005.01	2006.12	224	300	-	8		X	X	JM5406	8	sys. Mitsubishi; VIN (M)
5.3	2005.01	2006.12	224	300	-	8		X	X	JM5439	8	sys. Delphi; VIN (M)



## ISUZU USA

ASCENDER												
5.3 4WD	2005.01	2006.12	224	300	-	8		X	X	JM5406	8	sys. Mitsubishi; VIN (M)
5.3 4WD	2005.01	2006.12	224	300	-	8		X	X	JM5439	8	sys. Delphi; VIN (M)
HOMBRE												
2.2	1995.09	1996.12	88	118	-	4		X	X	JM5290	2	VIN (4)
2.2	1996.09	2000.12	88	120	-	4		X	X	JM5290	2	VIN (4)
2.2 4WD	1997.09	2000.12	90	122	-	4		X	X	JM5290	2	VIN (4)
2.2 Flexfuel	1999.09	2000.12	90	122	-	4		X	X	JM5290	2	VIN (4)
2.2 Flexfuel 4WD	1999.09	2000.12	90	122	-	4		X	X	JM5290	2	VIN (4)
4.3	1996.09	1999.12	131	178	-	6		X	X	JM5385	1	VIN (X)
4.3 4WD	1997.09	1999.12	131	178	-	6		X	X	JM5385	1	VIN (X)
4.3 V6 262cid	2000.01	2000.12			-	6		X	X	JM5385	1	VIN (W)
I-MARK												
1.5 8V	1987.01	1989.12	52	71	-	4		X	X	JM5145	1	VIN (7)
1.5 8V	1987.01	1989.12	52	71	-	4		X	X	JM5369	1	VIN (9)
1.6 16V	1989.01	1989.12	93	126	-	4		X	X	JM5369	1	VIN (5)
IMPULSE												
1.6 16V	1990.01	1991.12	-	-	-	4	1/4	JP109	JPE109	JM5369	1	VIN (5)
1.6 16V	1991.01	1992.12	-	-	-	4		X	X	JM5290	2	VIN (4)
1.8 16V	1992.01	1992.12	-	-	-	4		X	X	JM5369	1	VIN (8)
PICKUP												
2.3 8V	1990.01	1995.12	72	98	-	4		X	X	JM5358	1	VIN (L)
2.3 8V AWD	1990.01	1995.12	72	98	-	4		X	X	JM5358	1	VIN (L)
2.6 8V	1988.01	1995.12	90	122	-	4		X	X	JM5358	1	VIN (E)
2.6 8V AWD	1988.01	1995.12	90	122	-	4		X	X	JM5358	1	VIN (E)
3.1 12V	1991.01	1994.12	90	122	-	6		X	X	JM5369	1	VIN (Z)
3.1 12V AWD	1991.01	1994.12	90	122	-	6		X	X	JM5369	1	VIN (Z)
RODEO												
2.2	1997.09	2003.12	96	131	-	4		X	X	JM5038	1	VIN (D)
2.2 4WD	1997.09	2003.12	96	131	X22SE	4		X	X	JM5038	1	VIN (D)
2.6 8V	1991.01	1997.12	90	122	-	4		X	X	JM5358	1	VIN (E)
2.6 8V AWD	1991.01	1997.12	90	122	-	4		X	X	JM5358	1	VIN (E)
3.1 12V	1991.01	1992.12	90	122	-	6		X	X	JM5369	1	VIN (Z)
3.1 12V AWD	1991.01	1992.12	90	122	-	6		X	X	JM5369	1	VIN (Z)
3.2 24V	1993.01	1995.12	131	178	-	6	-/6	JP132	JPE132	JM5290	3	VIN (V)
3.2 24V AWD	1993.01	1995.12	131	178	-	6	-/6	JP132	JPE132	JM5290	3	VIN (V)
3.2 24V	1996.01	1997.12	131	178	-	6	-	-	-	X	6	VIN (V)
3.2 24V AWD	1996.01	1997.12	131	178	-	6	-	-	-	X	6	VIN (V)
STYLUS												
1.6 16V	1991.01	1991.12	71	97	-	4		X	X	JM5369	1	VIN (5), VIN (6)
1.8 16V	1992.01	1992.12	104	141	-	4		X	X	JM5369	1	VIN (8)
TROOPER												
2.6 8V AWD	1988.01	1991.12	90	122	-	4		X	X	JM5358	1	VIN (E)
2.8 12V AWD	1989.01	1991.12	90	122	-	6		X	X	JM5369	1	VIN (R)
3.2 4WD	1991.09	1995.12	131	178	-	6		X	X	JM5290	3	VIN (V)

## JAGUAR USA

420												
4.2	1966.09	1967.12	-	-	-	6		X	X	JM5455	1	+ resistor
MARK												
3.4	1956.09	1958.12	-	-	-	6		X	X	JM5455	1	+ resistor
3.8	1961.09	1964.12	-	-	-	6		X	X	JM5455	1	+ resistor
4.2	1963.09	1966.12	-	-	-	6		X	X	JM5455	1	+ resistor
S-TYPE												
3.0 V6 DOHC	2000.01	2003.12	-	-	138cid.	6	-	-	-	JM5077	6	JM1198; VIN (F)
3.0	2003.01	2006.12	179	243	-	6	-	-	-	JM5407	6	VIN (T); OE C2S11480
3.0	2006.09	2007.12	175	235	-	6	-	-	-	JM5407	6	VIN (A); OE C2S11480
3.0	2007.09	2008.12	175	235	-	6	-	-	-	JM5407	6	VIN (A); OE C2S11480
4.0 V8 DOHC	2000.01	2002.12	-	-	244cid.	8		X	X	JM5078	8	VIN (G)
4.2 V8 DOHC	2003.01	#ARG!	-	-	-	8		X	X	JM5078	8	VIN M21730-M45255
VANDEN PLAS												
4.0 24V	1995.01	1997.12	-	-	-	6	-	-	-	JM5323	6	
4.0	2000.01	2002.12	216	290	-	8	-	-	-	JM5421	8	VIN --> 853935 2-PINS VIN (B); VIN (C)
4.0	2000.01	2002.12	216	290	-	8	-	-	-	JM5401	8	VIN 863936 --> 4-PINS
4.2	1981.09	1984.12	131	176	-	6		X	X	JM5355	1	VIN (2), VIN (3)

**JAGUAR USA**

<b>XJ</b>													
3.6 XJ6 Sovereign	1986.09	1987.12	135	181	-	6		X	X	JM5355	1	VIN (5)	
4.0	1997.09	2003.12	209	281	-	8	-	-	-	JM5421	8	XJ8 V8; VIN -->	
4.0	1997.09	2003.12	216	290	-	8	-	-	-	JM5421	8	853935; 2-PINS	
4.0	1997.09	2003.12	276	370	-	8	-	-	-	JM5421	8		
4.0	1999.01	2003.12	209	281	-	8	-	-	-	JM5401	8	XJ8 V8; 4-PINS	
4.0	1999.01	2003.12	216	290	-	8	-	-	-	JM5401	8	XJ8 V8; 4-PINS	
4.0	1999.01	2003.12	276	370	-	8	-	-	-	JM5401	8	XJ8 V8; 4-PINS	
4.0	1999.01	2003.12	276	370	-	8	-	-	-	JM5401	8	XJR V8; 4-PINS	
4.2	1971.09	1974.12	151	205	-	6		X	X	JM5455	1	XJ6; + resistor	
4.2	1971.09	1974.12	151	205	-	6		X	X	JM5355	1	XJ6	
4.2	1971.09	1974.12	183	249	-	6		X	X	JM5455	1	XJ6; + resistor	
4.2	1971.09	1974.12	183	249	-	6		X	X	JM5355	1	XJ6	
4.2	1974.09	1977.12	121	162	-	6		X	X	JM5355	1	XJ6	
5.3	1972.09	1974.12	186	254	-	12		X	X	JM5455	1	XJ12; + resistor	
5.3	1972.09	1974.12	186	254	-	12		X	X	JM5355	1	XJ12	
5.3	1972.09	1974.12	223	304	-	12		X	X	JM5455	1	XJ12; + resistor	
5.3	1972.09	1974.12	223	304	-	12		X	X	JM5355	1	XJ12	
5.3	1974.09	1976.12	182	244	-	12		X	X	JM5455	1	XJ12; + resistor	
5.3	1974.09	1976.12	182	244	-	12		X	X	JM5355	1	XJ12	
5.3	1974.09	1979.12	182	244	-	12		X	X	JM5455	1	XJ12; + resistor	
5.3	1974.09	1979.12	182	244	-	12		X	X	JM5355	1	XJ12; VIN (V), VIN (X)	
5.3	1974.09	1981.12	182	244	-	12		X	X	JM5355	1	XJS; VIN (V), VIN (X), VIN (8)	
5.3	1980.09	1981.12	195	262	-	12		X	X	JM5355	1	XJS; VIN (8)	
6.0	1993.09	1996.12	224	301	-	12	2/12	RVS40	RVU40	JM5221	2	XJ12; w / Dist. OE DAC4608	
6.0	1993.09	1996.12	224	301	-	12		X	X	JM5073	2	XJ12; wo / Dist. OE LNA1508AA	
<b>XJ 6</b>													
4.0 24V	1995.01	1997.12	-	-	AJ16	6	-	-	-	JM5323	6		
<b>XJR</b>													
4.0 24V	1995.01	1997.12	183	245	AJ16	6	-	-	-	JM5323	6	XJR L6; 2-PINS; 4-PINS OE LCA1510AB	
<b>XJS</b>													
4.0 24V	1995.01	1995.12	163	219	AJ16	6	-	-	-	JM5323	6		
4.0 24V	1995.01	1996.12	163	219	-	6	-	-	-	JM5323	6		
5.3	1975.09	1980.12	196	267	-	12		X	X	JM5455	1		
6.0 2+2	1994.09	1995.12	224	301	-	12	2/12	RVS40	RVU40	JM5221	2	w / Dist.; OE DAC4608	
6.0 2+2	1995.01	1995.12	224	301	-	12		X	X	JM5073	2	wo / Dist. OE LNA1508AA	
<b>XK 8</b>													
4.0	1999.09	2002.12	209	281	-	8	-	-	-	JM5401	8	VIN (C)	
<b>XK 120 / 140 / 150</b>													
3.4	1948.09	1954.12	119	162	-	6		X	X	JM5210	1	U=12[V]	
3.4	1957.01	1957.12	-	-	-	6		X	X	JM5455	1	+ resistor	
3.4	1957.09	1961.12	-	-	-	6		X	X	JM5455	1	+ resistor	
3.8	1959.01	1961.12	-	-	-	6		X	X	JM5455	1	+ resistor	
<b>XKE</b>													
5.3	1970.09	1974.12	180	241	-	12		X	X	JM5355	1		
<b>XKR</b>													
4.0 V8 Supercharged	2000.01	2002.12	-	-	-	8		X	X	JM5401	8	VIN (B) OE LNE1510AB	
<b>X-TYPE</b>													
2.5 AWD	2004.09	2005.12	143	192	-	6	-	-	-	JM5407	6	OE C2S11480	
3.0 AWD	2001.09	2006.12	169	227	-	6	-	-	-	JM5407	6	OE C2S11480	
<b>JEEP</b>													
<b>CHEROKEE</b>													
2.4	2001.09	2007.10	108	147	ED1	4	-/4	AM15	AMU15	JM5071	1	OE 04557468	
2.4	2001.09	2007.10	108	147	ED1	4	-/4	AM15	AMU15	JM5070	1	OE 05269670	
2.5	1986.10	1990.09	90	122	-	4	1/4	AM62	AMU62	JM5287	1		
2.5	1986.10	1990.09	90	122	EPE	4	1/4	AM62	AMU62	JM5288	1		
2.5 4x4	1986.10	1990.09	90	122	-	4	1/4	AM62	AMU62	JM5287	1		
2.5 4x4	1986.10	1990.09	90	122	EPE	4	1/4	AM62	AMU62	JM5288	1		
2.5	1990.10	1996.09	89	121	-	4	1/4	AM63	AMU63	JM5287	1		
2.5	1990.10	1996.09	89	121	EPE	4	1/4	AM63	AMU63	JM5288	1		
2.5 i 4x4	1991.12	1997.12	90	122	EPE, HX	4	1/4	AM63	AMU63	JM5288	1	VIN (P)	
2.5	1995.10	1997.12	89	121	EPE	4		X	X	JM5288	1		



<b>JEEP</b>												
<b>CHEROKEE</b>												
2.5 SE	1996.10	1999.09	87	118	-	4	1/4	AM61	AMU61	JM5287	1	
2.5 SE	1996.10	1999.09	87	118	EPE	4	1/4	AM61	AMU61	JM5288	1	
2.5 i	1996.11	2001.09	87	118	EPE	4	1/4	AM61	AMU61	JM5287	1	
2.5 i	1996.11	2001.09	87	118	EPE	4	1/4	AM61	AMU61	JM5288	1	
2.5	1998.01	2001.09	89	121	EPE	4		X	X	JM5287	1	
2.5 i 4x4	2008.01	2001.09	90	122	EPE, HX	4	1/4	AM63	AMU63	JM5287	1	VIN (P)
2.8 4x4	1983.10	1986.09	81	110	-	6	1/6	AM3	AMU3	JM5289	1	
2.8 4x4	1984.01	1984.12	81	110	-	6	1/6	AM3	AMU3	JM5368	1	VIN (W); California
2.8 4x4	1984.01	1984.12	81	110	-	6	1/6	AM3	AMU3	JM5369	1	VIN (W); Exc. California
3.7 V6	2001.09	2010.12	155	211	EVA	6	-	-	-	JM5286	6	
3.7 Laredo	2001.10	2004.09	150	204	EKG	6	-	-	-	JM5286	6	OE 56028138
3.7 V6	2003.08	-->	150	204	-	6	-	-	-	JM5286	6	
4.0	1986.10	1990.09	131	178	M400L	6	1/6	AM64	AMU64	JM5236	1	VIN (M), VIN (L) - module
4.0	1986.10	1990.09	131	178	M400L	6	1/6	AM64	AMU64	JM5242	1	VIN (M), VIN (L) + module
4.0 4x4	1986.10	1990.09	131	178	M400L	6	1/6	AM64	AMU64	JM5236	1	VIN (M), VIN (L) - module
4.0 4x4	1986.10	1990.09	131	178	M400L	6	1/6	AM64	AMU64	JM5242	1	VIN (M), VIN (L) + module
4.0 i	1988.01	1990.12	136	185	ERH	6	1/6	AM64	AMU64	JM5242	1	VIN (M), VIN (L) + module
4.0 i	1988.01	1990.12	136	185	ERH	6	1/6	AM64	AMU64	JM5236	1	VIN (M), VIN (L) - module
4.0 i	1990.10	1997.12	125	170	ERH	6	1/6	AM65	AMU65	JM5288	1	VIN (S); OE 5234210
4.0 i	1990.10	1994.12	125	170	ERH	6	1/6	AM65	AMU65	JM5387	1	VIN (S); OE 4762311
4.0 i	1991.01	1997.12	136	185	ERH	6	1/6	AM65	AMU65	JM5288	1	VIN (S); OE 56027965
4.0 i	1991.01	1994.12	136	185	ERH	6	1/6	AM65	AMU65	JM5387	1	VIN (S); OE 4762312
4.0 i	1991.12	1997.12	135	184	MX	6	1/6	AM65	AMU65	JM5288	1	VIN (S); OE 56027965
4.0 i	1991.12	1994.12	135	184	MX	6	1/6	AM65	AMU65	JM5387	1	VIN (S); OE 4762312
4.0 i	1995.01	1997.12	131	178	ERH	6	1/6	AM65	AMU65	JM5288	1	VIN (S); OE 5234210
4.0 i	1998.01	1999.12	125	170	ERH	6	1/6	AM65	AMU65	JM5287	1	VIN (S); OE 56028172
4.0 i	1998.01	1999.12	131	178	ERH	6	1/6	AM65	AMU65	JM5287	1	VIN (S); OE 56028172
4.0 i	1998.01	1999.12	135	184	MX	6	1/6	AM65	AMU65	JM5287	1	VIN (S); OE 56028172
4.0 i	1998.01	1999.12	136	185	ERH	6	1/6	AM65	AMU65	JM5287	1	VIN (S); OE 56028172
4.0 i	1998.07	1999.12	127	173	-	6	1/6	AM65	AMU65	JM5287	1	VIN (S); OE 56028172
4.0 i	1998.07	1998.12	127	173	-	6	1/6	AM65	AMU65	JM5288	1	VIN (S); OE 56027965
4.0 i	1998.07	1999.12	135	184	-	6	1/6	AM65	AMU65	JM5287	1	VIN (S); OE 56028172
4.0 i	1998.07	1998.12	135	184	-	6	1/6	AM65	AMU65	JM5288	1	VIN (S); OE 56027965
4.0 i	2000.01	2001.09	125	170	ERH	6	-	-	-	JM5502	1	VIN (S) OE 56041476AA
4.0 i	2000.01	2001.09	127	173	-	6	-	-	-	JM5502	1	VIN (S) OE 56041476AA
4.0 i	2000.01	2001.09	131	178	ERH	6	-	-	-	JM5502	1	VIN (S) OE 56041476AA
4.0 i	2000.01	2001.09	135	184	MX	6	-	-	-	JM5502	1	VIN (S) OE 56041476AA
4.0 i	2000.01	2001.09	135	184	-	6	-	-	-	JM5502	1	VIN (S) OE 56041476AA
4.0 i	2000.01	2001.09	136	185	ERH	6	-	-	-	JM5502	1	VIN (S) OE 56041476AA
4.2 4x4	1980.10	1983.12	76	103	-	6	1/6	AM84	AMU84	JM5622	1	VIN (C)
<b>CJ5 - CJ8</b>												
2.5	1983.01	1983.12	65	88	-	4		X	X	JM5622	1	VIN (U)
2.5	1984.01	1986.12	78	106	-	4		X	X	JM5622	1	VIN (U)
3.8	1974.01	1978.12	74	100	-	6	1/6	AM84	AMU84	JM5613	1	VIN (E)
4.2	1972.01	1977.12	76	103	-	6	1/6	AM84	AMU84	JM5613	1	VIN (A)
4.2	1976.01	1977.12	76	103	-	6	1/6	AM84	AMU84	JM5613	1	VIN (A)
4.2	1978.01	1978.12	76	103	-	6	1/6	AM84	AMU84	JM5622	1	VIN (A)
4.2	1979.01	1986.12	76	103	-	6	1/6	AM84	AMU84	JM5622	1	VIN (C)
5.0	1973.01	1977.12	89	121	-	8		X	X	JM5613	1	VIN (H)
5.0	1978.01	1978.12	89	121	-	8		X	X	JM5613	1	VIN (H); sys. Prestolite
5.0	1978.01	1978.12	89	121	-	8		X	X	JM5622	1	VIN (H); sys. Motorcraft
5.0	1979.01	1981.12	89	121	-	8		X	X	JM5622	1	VIN (H)
<b>COMANCHE</b>												
4.0	1990.10	1991.12	127	173	-	6	1/6	AM64	AMU64	JM5236	1	VIN (L) OE 12336238
4.0	1991.01	1992.12	127	173	-	6	1/6	AM65	AMU65	JM5288	1	VIN (S) OE 56027965
4.0	1991.01	1992.12	127	173	-	6	1/6	AM65	AMU65	JM5387	1	VIN (S); OE 4762312



<b>JEEP</b>													
<b>COMANCHE</b>													
4.0 4x4	1987.10	1990.12	130	178	ERH		6	1/6	AM64	AMU64	JM5236	1	VIN (M), VIN (L) OE 12336238
4.0 4x4	1991.01	1992.12	130	178	ERH		6	1/6	AM65	AMU65	JM5288	1	VIN (S); OE 56027965
4.0 4x4	1991.01	1992.12	130	178	ERH		6	1/6	AM65	AMU65	JM5387	1	VIN (S); OE 4762312
4.0	1990.10	1990.12	130	178	ERH		6	1/6	AM64	AMU64	JM5288	1	VIN (L); OE 12336238
4.0	1990.10	1992.12	130	178	ERH		6	1/6	AM65	AMU65	JM5288	1	VIN (S); OE 56027965
4.0	1990.10	1992.12	130	178	ERH		6	1/6	AM65	AMU65	JM5387	1	VIN (S); OE 4762312
<b>COMMANDER</b>													
3.7 V6	2005.09	2007.10	157	214	-		6	-	-	-	JM5286	6	
4.7 V8	2005.09	2007.10	170	231	-		8	-	-	-	JM5286	8	
<b>COMPASS</b>													
2.0	2008.01	2011.05	115	156	EKG		4	-	-	-	JM5404	4	
2.4	2006.08	2008.12	125	170	ERZ		4	-	-	-	JM5404	4	VIN (W)
2.4 4x4	2006.08	2008.12	125	170	ED1		4	-	-	-	JM5404	4	VIN (W)
2.4	2009.01	-->	125	170	ERZ		4	-	-	-	JM5404	4	VIN (B)
2.4 4x4	2009.01	-->	125	170	ERZ		4	-	-	-	JM5404	4	VIN (B)
<b>GRAND CHEROKEE</b>													
3.7 Laredo	2004.10	2005.09	157	213	-		6	-	-	-	JM5286	6	
3.7 V6	2005.06	-->	157	214	-		6	-	-	-	JM5286	6	
4.0 i (ZJ)	1993.01	1997.12	132	180	ERH		6	1/6	AM65	AMU65	JM5288	1	VIN (S); OE 56027965
4.0 i (ZJ)	1993.01	1994.12	132	180	ERH		6	1/6	AM65	AMU65	JM5387	1	VIN (S); OE 4762312
4.0 i (ZJ)	1993.01	1997.12	135	184	MX		6	1/6	AM65	AMU65	JM5288	1	VIN (S); OE 56027965
4.0 i (ZJ)	1993.01	1994.12	135	184	MX		6	1/6	AM65	AMU65	JM5387	1	VIN (S); OE 4762312
4.0 i (Z)	1995.10	1997.12	130	177	S01		6	1/6	AM65	AMU65	JM5288	1	VIN (S); OE 56027965
4.0 Laredo	1996.10	1998.09	131	178	ERH		6	-	-	-	JM5501	1	OE 56041019
4.0 Laredo	1996.10	1998.09	131	178	ERH		6	1/6	AM65	AMU65	JM5287	1	OE 56028172
4.0 Laredo	1996.10	1998.09	131	178	ERH		6	1/6	AM65	AMU65	JM5288	1	OE 56027965
4.0 i (Z)	1998.01	1998.12	130	177	S01		6	1/6	AM65	AMU65	JM5287	1	VIN (S); OE 56028172
4.0 i (ZJ)	1998.01	1998.12	132	180	ERH		6	1/6	AM65	AMU65	JM5287	1	VIN (S); OE 56028172
4.0 i (ZJ)	1998.01	1998.12	135	184	MX		6	1/6	AM65	AMU65	JM5287	1	VIN (S); OE 56028172
4.0 i (Z)	1999.01	1999.04	130	177	S01		6	-	-	-	JM5501	1	VIN (S); OE 56041019
4.0 i (Z)	1999.01	1999.04	130	177	S01		6	-	-	-	JM5502	1	VIN (S); OE 56028172
4.0 i (Z)	1999.01	1994.12	130	177	S01		6	1/6	AM65	AMU65	JM5387	1	VIN (S); OE 4762312
4.0 i (ZJ)	1999.01	1999.04	132	180	ERH		6	-	-	-	JM5501	1	VIN (S); OE 56041019
4.0 i (ZJ)	1999.01	1999.04	132	180	ERH		6	-	-	-	JM5502	1	VIN (S); OE 56028172
4.0 i (ZJ)	1999.01	1999.04	135	184	MX		6	-	-	-	JM5501	1	VIN (S); OE 56041019
4.0 i (ZJ)	1999.01	1999.04	135	184	MX		6	-	-	-	JM5502	1	VIN (S); OE 56028172
4.0	1999.04	2005.09	140	190	ERH		6	-	-	-	JM5501	1	OE 56041019
4.0	1999.04	2005.09	140	190	ERH		6	-	-	-	JM5502	1	OE 56041476AA
4.0	1999.04	2005.09	140	190	ERH		6		X	X	JM5287	1	OE 56028172
4.0	1999.04	2005.09	140	190	ERH		6		X	X	JM5288	1	OE 56027965
4.7 V8	1999.04	2000.08	162	220	-		8	-	-	-	JM5286	8	
4.7 V8	2000.08	2005.09	164	223	EVA		8	-	-	-	JM5286	8	
4.7 V8	2001.10	-->	190	258	-		8	-	-	-	JM5286	8	
4.7 V8 4x4	2003.06	2010.12	167	227	-		8	-	-	-	JM5286	8	
4.7	2004.10	-->	167	227	-		8	-	-	-	JM5286	8	
4.7 V8	2005.06	-->	170	231	-		8	-	-	-	JM5286	8	
5.2 i (ZJ)	1992.01	1999.04	155	211	ELF		8	1/8	AM66	AMU66	JM5288	1	
5.2 i (ZJ)	1992.09	1999.04	158	215	Y		8	1/8	AM66	AMU66	JM5288	1	
5.2 (Z)	1995.10	1999.04	156	212	Y01		8	1/8	AM66	AMU66	JM5287	1	
5.2 (Z)	1995.10	1999.04	156	212	Y01		8	1/8	AM66	AMU66	JM5288	1	
5.2	1996.10	1998.09	164	223	-		8	1/8	AM66	AMU66	JM5287	1	
5.2 4WD	1996.10	1998.09	164	223	-		8	1/8	AM66	AMU66	JM5287	1	
5.2	1996.10	1998.09	164	223	ELF		8	1/8	AM66	AMU66	JM5288	1	
5.2 4WD	1996.10	1998.09	164	223	ELF		8	1/8	AM66	AMU66	JM5288	1	
5.2 Limited 4x4	1996.10	1998.09	136	185	-		8	1/8	AM66	AMU66	JM5287	1	
5.2 Limited 4x4	1996.10	1998.09	136	185	ELF		8	1/8	AM66	AMU66	JM5288	1	
5.7 V8	2005.07	2008.12	240	326	EZB		8		X	X	JM5281	8	
5.7 V8	2006.01	-->	240	326	EZB		8	-	-	-	JM5422	8	
5.9 i	1997.08	1999.04	177	241	-		8	1/8	AM66	AMU66	JM5287	1	
6.1 SRT8	2006.03	2007.04	313	426	ESF		8	-	-	-	JM5422	8	
<b>PATRIOT</b>													
2.0	2008.01	2011.12	115	156	EKG		4	-	-	-	JM5404	4	
2.4	2005.07	2008.12	125	170	ED3		4	-	-	-	JM5404	4	VIN (W)
2.4 ECO+	2008.01	2008.12	125	170	ED3		4	-	-	-	JM5404	4	VIN (W)
2.4	2009.01	-->	125	170	ED3		4	-	-	-	JM5404	4	VIN (B)
2.4 ECO+	2009.01	-->	125	170	ED3		4	-	-	-	JM5404	4	VIN (B)



## JEEP

WRANGLER												
2.4	2002.11	2010.12	105	143	-	4		X	X	JM5070	1	
2.5	1988.01	1991.12	76	103	-	4	1/4	AM63	AMU63	JM5236	1	
2.5	1991.12	1996.08	89	121	EPE	4	1/4	AM63	AMU63	JM5287	1	
2.5	1991.12	1996.08	89	121	EPE	4	1/4	AM63	AMU63	JM5288	1	
2.5	1996.08	2007.04	87	118	P00	4	1/4	AM63	AMU63	JM5287	1	
2.5	1996.08	2007.04	87	118	P00	4	1/4	AM63	AMU63	JM5288	1	
3.8	2006.03	-->	153	208	EGT	6		X	X	JM5443	1	
3.8 Rubicon rear wheel drive	2006.03	-->	153	208	EGT	6		X	X	JM5443	1	
3.8	2007.04	2011.12	146	199	EGT	6	-/6	AM85	AMU85	JM5443	1	OE 56032520
3.8	2010.01	2011.12	151	205	EGT	6	-/6	AM85	AMU85	JM5443	1	OE 56032520
4.0 2WD	1986.10	1990.09	131	178	M400L	6	1/6	AM65	AMU65	JM5236	1	
4.0 4WD	1986.10	1990.09	131	178	M400L	6	1/6	AM65	AMU65	JM5236	1	
4.0	1991.12	1996.08	131	178	ERH	6	1/6	AM65	AMU65	JM5287	1	OE 56028172
4.0	1991.12	1995.12	131	178	ERH	6	1/6	AM65	AMU65	JM5288	1	VIN (S); OE 56027965
4.0	1991.12	1993.12	131	178	ERH	6	1/6	AM65	AMU65	JM5387	1	VIN (S); OE 4762312
4.0	1996.08	1997.12	130	177	S01	6	1/6	AM65	AMU65	JM5288	1	VIN (S); OE 5234210
4.0	1996.08	1997.12	130	177	ERH	6	1/6	AM65	AMU65	JM5288	1	VIN (S); OE 5234210
4.0	1998.01	1999.12	124	169	-	6	1/6	AM65	AMU65	JM5287	1	w / Dist.; VIN (S) OE 56028172
4.0	1998.01	1999.12	130	177	S01	6	1/6	AM65	AMU65	JM5287	1	VIN (S); OE 56028172
4.0	1998.01	1999.12	130	177	ERH	6	1/6	AM65	AMU65	JM5287	1	VIN (S); OE 56028172
4.0	1998.01	1997.12	142	193	-	6	1/6	AM65	AMU65	JM5287	1	VIN (S); OE 56028172
4.0	1998.06	1998.12	124	169	-	6	1/6	AM65	AMU65	JM5288	1	w / Dist.; VIN (S) OE 5234210
4.0	1998.06	1997.12	142	193	-	6	1/6	AM65	AMU65	JM5288	1	VIN (S); OE 5234210
4.0	2000.01	2007.04	124	169	-	6	-	-	-	JM5502	1	wo / Dist.; VIN (S) OE 56041476AA
4.0	2000.01	2007.04	130	177	S01	6	-	-	-	JM5502	1	VIN (S); OE 5604176AA
4.0	2000.01	2007.04	130	177	ERH	6		X	X	JM5502	1	VIN (S) OE 56041476AA
4.0	2000.01	2006.03	142	193	-	6		X	X	JM5502	1	VIN (S) OE 56041476AA
4.0 Rubicon	2003.08	2007.04	128	174	-	6	-	-	-	JM5502	1	wo / Dist.; VIN (S) OE 56041476AA
4.0 Rubicon	2003.08	2007.04	128	174	-	6	1/6	AM65	AMU65	JM5287	1	w / Dist.; VIN (S) OE 56028172
4.0 Rubicon	2003.08	2007.04	128	174	-	6	1/6	AM65	AMU65	JM5288	1	w / Dist.; VIN (S) OE 5234210
4.2	1986.08	1989.08	84	114	6L <C 2V>	6	1/6	AM84	AMU84	JM5622	1	
4.2 2WD	1986.10	1990.09	82	111	-	6	1/6	AM84	AMU84	JM5622	1	

## JEEP USA

CHEROKEE												
2.8 12V AWD	1984.01	1984.12	86	117	-	6		X	X	JM5369	1	VIN (W); Exc. California
2.8 12V AWD	1984.01	1984.12	86	117	-	6		X	X	JM5368	1	VIN (W); California
2.8 12V	1985.01	1986.12	86	117	-	6		X	X	JM5369	1	VIN (W)
2.8 12V AWD	1985.01	1986.12	86	117	-	6		X	X	JM5369	1	VIN (W)
4.0	1991.01	1997.12	129	175	-	6	1/6	AM65	AMU65	JM5288	1	VIN (S); OE 56027965
4.0	1991.01	1994.12	129	175	-	6	1/6	AM65	AMU65	JM5387	1	VIN (S); OE 4762312
4.0 AWD	1991.01	1997.12	129	175	-	6	1/6	AM65	AMU65	JM5288	1	VIN (S); OE 56027965
4.0 AWD	1991.01	1994.12	129	175	-	6	1/6	AM65	AMU65	JM5387	1	VIN (S); OE 4762312
4.0	1998.01	1999.12	129	175	-	6	1/6	AM65	AMU65	JM5287	1	VIN (S); OE 56028172
4.0 AWD	1998.01	1999.12	129	175	-	6	1/6	AM65	AMU65	JM5287	1	VIN (S); OE 56028172
4.0	2000.01	2001.12	129	175	-	6	-	-	-	JM5502	1	VIN (S) OE 56041476AA
4.0 AWD	2000.01	2001.12	129	175	-	6	-	-	-	JM5502	1	VIN (S) OE 56041476AA
4.2 4WD	1974.09	1976.12	76	103	-	6	1/6	AM84	AMU84	JM5613	1	VIN (A)
4.2 4WD	1977.01	1977.12	76	103	-	6	1/6	AM84	AMU84	JM5613	1	VIN (A); sys. Prestolite
4.2 4WD	1977.01	1977.12	76	103	-	6	1/6	AM84	AMU84	JM5622	1	VIN (A); sys. Motorcraft
4.2 4WD	1977.01	1977.12	76	103	-	6	1/6	AM84	AMU84	JM5613	1	VIN (C)
4.2 4WD	1978.01	1983.12	76	103	-	6	1/6	AM84	AMU84	JM5622	1	VIN (C)
CJ												
2.5 8V AWD (CJ5)	1980.01	1981.12	65	88	-	4		X	X	JM5367	1	VIN (B)
2.5 8V AWD (CJ7)	1980.01	1981.12	78	106	-	4		X	X	JM5367	1	VIN (B)
2.5 8V AWD (CJ5)	1982.01	1983.12	65	88	-	4		X	X	JM5368	1	VIN (B)
2.5 8V AWD (CJ7)	1982.01	1983.12	78	106	-	4		X	X	JM5368	1	VIN (B)
COMANCHE												
2.8 12V AWD	1986.01	1986.12	86	117	-	6		X	X	JM5369	1	VIN (W)



JEEP USA													
<b>COMANCHE</b>													
4.0	1986.09	1990.12	129	175	-		6	1/6	AM64	AMU64	JM5236	1	VIN (M), VIN (L) OE 12336238
4.0 4WD	1986.09	1990.12	129	175	-		6	1/6	AM64	AMU64	JM5236	1	VIN (M), VIN (L) OE 12336238
4.0	1991.01	1992.12	129	175	-		6	1/6	AM65	AMU65	JM5288	1	VIN (S); OE 56027965
4.0	1991.01	1992.12	129	175	-		6	1/6	AM65	AMU65	JM5387	1	VIN (S); OE 4762312
4.0 4WD	1991.01	1992.12	129	175	-		6	1/6	AM65	AMU65	JM5288	1	VIN (S); OE 56027965
4.0 4WD	1991.01	1992.12	129	175	-		6	1/6	AM65	AMU65	JM5387	1	VIN (S); OE 4762312
<b>COMPASS</b>													
2.0	2007.01	2008.12	-	-	-		4		X	X	JM5404	4	VIN (O)
2.0	2009.01	2009.12	-	-	AJ-V6		4		X	X	JM5404	4	VIN (A)
2.0	2010.09	-->	118	158	-		4		X	X	JM5404	4	
2.0 4WD	2010.09	-->	118	158	-		4		X	X	JM5404	4	
2.4	2006.09	2007.12	128	174	-		4	-	-	-	JM5404	4	VIN (W)
2.4 4WD	2006.09	2008.12	128	174	-		4	-	-	-	JM5404	4	VIN (W)
2.4 4WD	2009.01	2010.12	128	174	-		4	-	-	-	JM5404	4	VIN (B)
<b>GRAND CHEROKEE</b>													
4.0	1999.01	1999.12	146	195	-		6		X	X	JM5501	1	VIN (S) OE 56041019
4.0 AWD	1999.01	1999.12	146	195	-		6		X	X	JM5501	1	VIN (S) OE 56041019
4.0	2000.12	2004.12	146	195	-		6		X	X	JM5502	1	VIN (S) OE 56041476AA
4.0 AWD	2000.12	2004.12	146	195	-		6		X	X	JM5502	1	VIN (S) OE 56041476AA
5.7	2004.09	2005.12	243	325	HEMI		8		X	X	JM5281	8	VIN (2)
5.7 AWD	2004.09	2005.12	243	325	HEMI		8		X	X	JM5281	8	VIN (2)
<b>LIBERTY</b>													
2.4 DOHC	2002.01	2003.12	-	-	-		4		X	X	JM5070	1	VIN (1)
2.4 DOHC	2004.01	2007.11	-	-	AJ-V6		4		X	X	JM5070	1	VIN (1)
2.4 SPORT DOHC	2005.01	2009.12	-	-	-		4		X	X	JM5070	1	VIN (1)
<b>PATRIOT</b>													
2.0	2007.09	2008.12	118	158	-		4	-	-	-	JM5404	4	VIN (O)
2.0 4WD	2007.09	2008.12	118	158	-		4	-	-	-	JM5404	4	VIN (O)
2.0	2009.01	2010.12	118	158	-		4	-	-	-	JM5404	4	VIN (A)
2.0 4WD	2009.01	2010.12	118	158	-		4	-	-	-	JM5404	4	VIN (A)
2.4	2006.09	2008.12	128	174	-		4	-	-	-	JM5404	4	VIN (W)
2.4 4WD	2006.09	2008.12	128	174	-		4	-	-	-	JM5404	4	VIN (W)
2.4	2009.01	2010.12	128	174	-		4	-	-	-	JM5404	4	VIN (B)
<b>SCRAMBLER</b>													
2.5 8V AWD	1981.01	1981.12	61	83	-		4		X	X	JM5367	1	VIN (B)
2.5 8V AWD	1982.01	1983.12	61	83	-		4		X	X	JM5368	1	VIN (B)
<b>TJ</b>													
4.0 L6	1997.01	1997.12	-	-	242cid		6	1/6	AM65	AMU65	JM5288	1	VIN (S); OE 5234210
4.0 L6	1998.01	1999.12	-	-	242cid		6	1/6	AM65	AMU65	JM5287	1	VIN (S); OE 56028172
4.0 L6	2000.01	2006.12	-	-	242cid		6		X	X	JM5502	1	VIN (S) OE 56041476AA
<b>WAGONEER</b>													
2.8 12V AWD	1984.01	1984.12	86	117	-		6		X	X	JM5369	1	VIN (W); California
2.8 12V AWD	1984.01	1984.12	86	117	-		6		X	X	JM5368	1	VIN (W); California
2.8 12V AWD	2005.01	1986.12	86	117	-		6		X	X	JM5369	1	VIN (W)
4.0	1988.09	1989.12	132	180	-		6	1/6	AM64	AMU64	JM5236	1	VIN (L); OE 12336238
4.0 4WD	1986.09	1990.12	129	175	-		6	1/6	AM64	AMU64	JM5236	1	VIN (M), VIN (L) OE 12336238
<b>WRANGLER</b>													
2.4 DOHC	2003.01	2003.12	-	-	148cid.		4		X	X	JM5070	1	VIN (1)
2.4 DOHC	2004.01	2006.12	-	-	148cid.		4		X	X	JM5070	1	VIN (1)
3.8 (X)	2006.09	2011.12	151	205	-		6	-/6	AM85	AMU85	JM5443	1	VIN (1); OE 56032520
4.0 AWD	1990.09	1995.12	144	193	-		6	1/6	AM65	AMU65	JM5288	1	VIN (S); OE 56027965
4.0 AWD	1990.09	1995.12	144	193	-		6	1/6	AM65	AMU65	JM5387	1	VIN (S); OE 4762312
4.0 AWD	2000.01	2006.12	130	177	-		6	-	-	-	JM5502	1	VIN (S)
4.0	2000.01	2006.12	142	193	-		6	-	-	-	JM5502	1	OE 56041476AA
<b>JENSEN USA</b>													
<b>HEALEY</b>													
2.0	1974.09	1975.12	104	142	-		4		X	X	JM5455	1	+ resistor
2.0	1975.09	1976.12	104	142	-		4		X	X	JM5455	1	+ resistor



## KIA USA

FORTE												
2.0	2010.01	2010.12	-	-	-	4	-	-	-	JM5373	4	VIN (2)
2.4	2010.01	2010.12	-	-	-	4	-	-	-	JM5373	4	VIN (4)
MAGENTIS												
2.5 V6	2000.01	2001.12	-	-	-	6	-/6	JP178	JPE178	JM5119	1	coil set OE 27301-37100
2.5 V6	2000.01	2001.12	-	-	-	6	-/6	JP178	JPE178	JM5347	3	single coil OE 27310-37100
2.7	2004.09	2006.12	127	173	-	6	-/6	JP178	JPE178	JM5119	1	coil set OE 27301-37100
2.7	2004.09	2006.12	127	173	-	6	-/6	JP178	JPE178	JM5347	3	single coil OE 27310-37100
2.7 V6	2007.01	2010.10	-	-	-	6		X	X	JM5379	6	VIN (4)
OPTIMA												
2.5	2000.09	2001.12	124	169	-	6	-/6	JP178	JPE178	JM5119	1	coil set OE 27301-37100
2.5	2000.09	2001.12	124	169	-	6	-/6	JP178	JPE178	JM5347	3	single coil OE 27310-37100
2.5	2000.09	2001.12	127	173	-	6	-/6	JP178	JPE178	JM5119	1	coil set OE 27301-37100
2.5	2000.09	2001.12	127	173	-	6	-/6	JP178	JPE178	JM5347	3	single coil OE 27310-37100
2.7	2001.09	2005.12	138	187	-	6	-/6	JP178	JPE178	JM5119	1	coil set OE 27301-37100
2.7	2001.09	2005.12	138	187	-	6	-/6	JP178	JPE178	JM5347	3	single coil OE 27310-37100
2.7	2004.09	2005.12	145	197	-	6	-/6	JP178	JPE178	JM5119	1	coil set OE 27301-37100
2.7	2004.09	2005.12	145	197	-	6	-/6	JP178	JPE178	JM5347	3	single coil OE 27310-37100
2.7	2006.01	2006.12	138	187	-	6	-	-	-	JM5166	6	OE 27301-3E100
2.7 V6	2007.01	2010.10	-	-	-	6		X	X	JM5379	6	VIN (4)
RIO												
1.6 16V	2006.01	2010.12	82	112	-	4	-	-	-	JM5344	4	VIN (3) OE 27301-26640
RONDO												
2.4	2007.01	2010.12	-	-	-	4	-	-	-	JM5344	4	VIN (8) OE 27301-26640
2.4	2007.01	2008.05	-	-	-	4	-	-	-	JM5373	4	VIN (5) OE 27300-3F100
2.7	2007.01	2010.12	-	-	-	6	-	-	-	JM5379	6	VIN (6)
SORENTO												
2.4	2011.01	2011.12	-	-	-	4		X	X	JM5373	4	VIN (1)
3.5 24V	2003.01	2003.12	-	-	-	6		X	X	JM5321	3	
3.5 24V	2003.01	2006.12	143	194	-	6		X	X	JM5321	3	
SOUL												
2.0	2010.01	2010.12	-	-	-	4		X	X	JM5346	1	
SPECTRA												
2.0	2008.01	2009.12	-	-	-	4		X	X	JM5346	1	VIN (1), VIN (2)
2.0 16V	2008.01	2009.12	103	140	-	4		X	X	JM5346	1	
SPORTAGE												
2.0 DOHC	1995.01	1998.12	-	-	-	4		X	X	JM5065	2	
2.0 DOHC	1999.01	2002.12	-	-	FED	4		X	X	JM5065	2	
2.0 DOHC	2001.01	-->	-	-	FED	4		X	X	JM5065	2	
2.0	2008.01	2009.12	-	-	-	4		X	X	JM5346	1	VIN (4)
LAND ROVER USA												
LAND ROVER												
1.6	1950.01	1951.12	-	-	-	4		X	X	JM5335	1	for BOSCH GT40T R1=3.0[Ω], R2=8.5[kΩ]
2.0	1952.01	1957.12	-	-	-	4		X	X	JM5335	1	for BOSCH GT40T R1=3.0[Ω], R2=8.5[kΩ]
2.3	1958.01	1961.12	-	-	-	4		X	X	JM5335	1	for BOSCH GT40T R1=3.0[Ω], R2=8.5[kΩ]
2.3	1963.01	1969.12	-	-	-	4		X	X	JM5335	1	for BOSCH GT40T R1=3.0[Ω], R2=8.5[kΩ]
2.6	1963.01	1969.12	-	-	-	6		X	X	JM5335	1	for BOSCH GT40T R1=3.0[Ω], R2=8.5[kΩ]
DEFENDER												
4.0 16V AWD	1997.01	1997.12	140	188	-	8		X	X	JM5327	4	VIN (2)
DISCOVERY												
4.0 16V AWD	1996.01	1997.12	140	188	-	8		X	X	JM5327	4	VIN (2)
4.0 16V AWD	1996.01	1998.12	140	188	-	8		X	X	JM5327	4	VIN (2)
4.0 16V AWD	1999.01	1999.12	140	188	-	8		X	X	JM5327	4	Model SD



**LAND ROVER USA**

DISCOVERY												
4.0 16V AWD	1999.01	2002.12	140	188	-	8			X	X	JM5032	2 Series II
4.0 4WD	1999.01	2002.12	140	188	-	8			X	X	JM5611	1 Series II; coil set
4.6 4WD	2002.09	2004.12	162	217	-	8			X	X	JM5611	1 coil set
LR3												
4.4 4WD	2004.09	2006.12	224	300	-	8	-	-			JM5475	8 VIN (5)
RANGE ROVER												
3.9 16V AWD	1995.01	1995.12	136	182	-	8			X	X	JM5327	4 VIN (2)
4.0 16V AWD	1996.01	1997.12	140	188	-	8			X	X	JM5327	4 VIN (2)
4.0 16V AWD	1996.01	1998.12	140	188	-	8			X	X	JM5327	4 VIN (2)
4.0 16V AWD	1999.01	2000.12	140	188	-	8			X	X	JM5032	2
4.0 4WD	1999.01	2000.12	140	188	-	8			X	X	JM5611	1 coil set
4.2 16V AWD	1995.01	1995.12	149	200	-	8			X	X	JM5327	4 VIN (3)
4.2 Supercharger	2005.09	2009.12	298	400	-	8	-	-			JM5475	8 VIN (3)
4.4 4WD	2005.09	2006.12	224	300	-	8	-	-			JM5475	8 VIN (5)
4.4 4x4	2006.09	2009.12	224	302	-	8	-	-			JM5475	8 VIN (5)
4.6 16V AWD	1996.01	1997.12	168	225	-	8			X	X	JM5327	4 VIN (4)
4.6 16V AWD	1996.01	1998.12	168	225	-	8			X	X	JM5327	4 VIN (4)
4.6 16V AWD	1999.01	2000.12	168	225	-	8			X	X	JM5032	2
4.6 4WD	1999.01	2002.12	168	225	-	8			X	X	JM5611	1 Series II; coil set
RANGE ROVER SPORT												
4.2 4WD	2005.09	2009.12	298	400	-	8	-	-			JM5475	8 VIN (3)
4.4 4WD	2005.09	2006.12	224	300	-	8	-	-			JM5475	8 VIN (5)

**LEXUS USA**

ES (250, 300, 330, 350)												
2.5	1989.09	1991.12	116	158	2VZ-FE	6			X	X	JM5148	1 OE 90919-02185
2.5 V6 DOHC	1990.01	1991.12	-	-	-	6			X	X	JM5148	1 VIN (V)
3.0	1991.09	2003.12	138	185	3VZ-FE	6			X	X	JM5444	1 OE 90919-02207
3.0	1992.09	1997.12	138	185	1MZ-FE	6	-	-			JM5394	6 OE 90919-02214
3.0	1993.09	1995.12	140	188	1MZ-FE	6	-	-			JM5394	6 OE 90919-02214
3.0	1995.09	1997.12	138	185	1MZ-FE	6			X	X	JM5427	3 OE 90919-02215
3.0	1996.01	1997.12	140	188	1MZ-FE	6			X	X	JM5427	3 OE 90919-02215
3.0 24V	1996.01	2001.12	140	190	-	6			X	X	X	3 w/o VVT
3.0	1998.09	2001.12	140	188	1MZ-FE	6	-	-			JM5332	6 w VVT OE 90919-02234
3.0	1998.09	2001.12	140	188	1MZ-FE	6			X	X	JM5427	3 w/o VVT OE 90919-02215
3.0 24V	1999.01	2003.12	140	190	-	6	-	-			JM5332	6 w VVT OE 90919-02234
3.0	2000.09	2003.12	140	188	1MZ-FE	6	-	-			JM5332	6 w VVT OE 90919-02234
3.0	2000.09	2001.12	140	188	1MZ-FE	6			X	X	JM5427	3 w/o VVT OE 90919-02215
3.0	2004.01	2005.12	138	185	1MZ-FE	6	-	-			JM5394	6 OE 90919-02214
3.0	2004.01	2003.12	138	185	3VZ-FE	6			X	X	JM5444	1 OE 90919-02207
3.0	2006.01	1997.12	138	185	1MZ-FE	6			X	X	JM5427	3 OE 90919-02215
3.3	2003.09	2006.12	163	222	3MZ-FE	6	-	-			JM5433	6 OE 90919-02246
3.5	2006.09	2009.12	203	276	3MZ-FE	6	-	-			JM5447	6 OE 90919-02251
GS (460)												
3.0	1992.09	1997.12	164	223	2JZ-FE	6			X	X	JM5444	1 OE 90919-02207
3.0	2005.09	2006.12	183	249	3GR-FSE	6	-	-			JM5182	6 OE 90919-02250
3.0 AWD	2005.09	2006.12	183	249	3GR-FSE	6	-	-			JM5182	6 OE 90919-02250
3.5	2006.09	2007.12	253	344	3GR-FSE	6	-	-			JM5182	6 OE 90919-02250
4.3	2000.09	2004.12	224	305	3UZ-FE	8	-	-			JM5184	8 OE 90919-02230
4.3	2005.09	2006.12	224	305	3UZ-FE	8	-	-			JM5184	8 OE 90919-02230
4.3	2006.09	2007.12	216	290	3UZ-FE	8	-	-			JM5184	8 OE 90919-02230
4.6 V8	2008.01	2009.12	255	347	1UR-FSE	8	-	-			JM5182	8 OE 90919-02250
GX												
4.7 4WD	2002.09	2006.12	175	238	2UZ-FE	8	-	-			JM5184	8 OE 90919-02230
4.7 4WD	2006.09	2009.12	196	263	2UZ-FE	8	-	-			JM5184	8 OE 90919-02230
IS (350)												
2.5	2005.09	2009.12	152	207	4GR-FSE	6	-	-			JM5182	6 OE 90919-02250
2.5 AWD	2005.09	2009.12	152	207	4GR-FSE	6	-	-			JM5182	6 OE 90919-02250
3.5	2005.09	2006.12	228	310	2GR-FSE	6	-	-			JM5447	6 OE 90919-02251
3.5	2007.01	2009.12	228	310	2GR-FSE	6	-	-			JM5182	6 OE 90919-02250
LS (400, 460, 600h)												
4.0 V8 DOHC	1989.09	1995.12	187	254	1UZ-FE	8			X	X	JM5149	2 VIN (U)



## LEXUS USA

LS (400, 460, 600h)												
4.3	2000.09	2006.12	207	283	3UZ-FE	8	-	-	-	JM5184	8	OE 90919-02230
4.6 V8	2007.01	2009.12	284	386	1UR-FSE	8	-	-	-	JM5182	8	OE 90919-02250
5.0 V8	2008.01	2009.12	327	445	2UR-FSE	8	-	-	-	JM5182	8	OE 90919-02250
LX (570)												
4.7	1997.09	2006.12	172	234	3UZ-FE	8	-	-	-	JM5184	8	OE 90919-02230
4.7 4WD	2006.09	2007.12	200	268	3UZ-FE	8	-	-	-	JM5184	8	OE 90919-02230
5.7 V8	2008.01	2009.12	286	389	3UR-FE	8	-	-	-	JM5182	8	OE 90919-02230
RX (300, 330, 350, 400H)												
3.0 24V	1999.01	2003.12	164	223	-	6	-	-	-	JM5332	6	OE 90919-02234
3.0 24V AWD	1999.01	2003.12	164	223	-	6	-	-	-	JM5332	6	OE 90919-02234
3.3	2003.09	2006.12	166	226	3MZ-FE	6	-	-	-	JM5435	6	
3.3 AWD	2003.09	2006.12	166	226	3MZ-FE	6	-	-	-	JM5435	6	
3.3	2005.09	2006.12	166	226	3MZ-FE	6	-	-	-	JM5435	6	Japan VIN #5*****g*****
3.3 AWD	2005.09	2006.12	166	226	3MZ-FE	6	-	-	-	JM5435	6	Japan VIN #5*****g*****
3.3	2005.09	2006.12	166	226	3MZ-FE	6	-	-	-	JM5433	6	Japan VIN #0*****4*****
3.3 AWD	2005.09	2006.12	166	226	3MZ-FE	6	-	-	-	JM5433	6	Japan VIN #0*****4*****
3.3	2005.09	2006.12	166	226	3MZ-FE	6	-	-	-	JM5435	6	USA
3.3 AWD	2005.09	2006.12	166	226	3MZ-FE	6	-	-	-	JM5435	6	USA
3.3	2005.09	2008.12	200	272	3MZ-FE	6	-	-	-	JM5433	6	OE 90919-02246
3.3 AWD	2005.09	2008.12	200	272	3MZ-FE	6	-	-	-	JM5433	6	OE 90919-02246
3.5	2006.09	2008.12	201	273	2GR-FE	6	-	-	-	JM5447	6	OE 90919-02251
3.5 AWD	2006.09	2008.12	201	273	2GR-FE	6	-	-	-	JM5447	6	OE 90919-02251
3.5	2008.09	2010.12	205	275	2GR-FE	6	-	-	-	JM5447	6	OE 90919-02251
3.5 AWD	2008.09	2010.12	205	275	2GR-FE	6	-	-	-	JM5447	6	OE 90919-02251
3.5 Hybrid	2010.09	-->	220	295	2GR-FE	6	-	-	-	JM5447	6	OE 90919-02251
3.5 Hybrid AWD	2010.09	-->	220	295	2GR-FE	6	-	-	-	JM5447	6	OE 90919-02251
SC (400)												
3.0	1991.09	2000.12	168	228	2JZ-FE	6	-	X	X	JM5444	1	OE 90919-02207
4.0 V8 DOHC	1991.09	1995.12	187	254	1UZ-FE	8	-	X	X	JM5149	2	VIN (U), VIN (H)
4.3	2001.09	2010.12	215	292	3UZ-FE	8	-	-	-	JM5184	8	OE 90919-02230

## LINCOLN

CONTINENTAL TOWN CAR												
4.6	1993.01	1994.01	142	193	-	8	-/8	AM53	AMU53	JM5092	2	
4.6 Signature	1994.01	1997.12	157	213	-	8	-/8	AM54	AMU54	JM5092	2	VIN (V)
4.6	1994.01	1997.12	209	284	V99V	8	-/8	AM54	AMU54	JM5092	2	VIN (V)
4.6 Signature	1998.01	1999.10	157	213	-	8	-	-	-	JM5088	8	JM1193; VIN (V)
4.6 Signature	1998.01	1999.10	157	213	-	8	-	-	-	JM5076	8	JM1190; VIN (W)
4.6	1998.01	2002.12	209	284	V99V	8	-	-	-	JM5088	8	JM1193; VIN (V)
4.6	1998.01	2003.12	209	284	V99V	8	-	-	-	JM5076	8	JM1190; VIN (W)
4.6	1998.06	2002.12	202	275	-	8	-	-	-	JM5088	8	JM1193; VIN (V)
LS												
3.0 V6 24V	1998.05	-->	140	190	-	6	-	-	-	JM5077	6	JM1198
3.9 V8 32V	1998.05	-->	180	245	-	8	-	-	-	JM5078	8	
MARK												
4.6	1992.10	1996.12	205	279	-	8	-	X	X	JM5092	2	
4.6	1997.01	1998.12	205	279	-	8	-	-	-	JM5088	8	JM1193
MKX												
3.7	2012.01	-->	227	309	-	6	-	X	X	JM5498	6	
3.7 AWD	2012.01	-->	227	309	-	6	-	X	X	JM5498	6	
NAVIGATOR												
5.4	1997.05	1999.12	224	305	-	8	-	-	-	JM5076	8	JM1190; VIN (L); SOHC
5.4 4x4	1997.05	1999.12	224	305	-	8	-	-	-	JM5076	8	JM1190; VIN (L); SOHC
5.4	1999.01	2004.12	224	305	-	8	-	-	-	JM5088	8	JM1193; VIN (A); DOHC
5.4 4x4	1999.01	2004.12	224	305	-	8	-	-	-	JM5088	8	JM1193; VIN (A); DOHC
TOWN CAR												
4.6	1997.10	2003.12	160	218	-	8	-	-	-	JM5076	8	JM1190
4.6	1999.09	2003.12	178	242	-	8	-	-	-	JM5076	8	JM1190

## LINCOLN USA

CONTINENTAL												
3.8 12V	1988.01	1994.12	104	141	-	6	-	X	X	JM5365	1	VIN (4)
4.6	1994.09	1997.12	194	264	-	8	-/8	AM54	AMU54	JM5092	2	VIN (V)



													<b>LINCOLN USA</b>	
<b>CONTINENTAL</b>														
4.6	1998.01	2002.12	194	264	-	8	-	-	-	-	JM5088	8	JM1193; VIN (V)	
5.0 16V	1984.01	1987.12	97	132	-	8		X	X		JM5365	1	VIN (F)	
<b>LS</b>														
3.0 V6 DOHC	2000.01	2005.12	-	-	138cid.	6	-	-	-	-	JM5077	6	JM1198; VIN (S)	
3.9 V8 DOHC	2000.01	-->	-	-	242cid.	8		X	X		JM5078	8	VIN (A)	
<b>MARK</b>														
4.6	1995.09	1996.12	209	284	-	8		X	X		JM5092	2	VIN (V)	
4.6	1997.01	1998.12	209	284	-	8	-	-	-		JM5088	8	JM1193; VIN (V)	
5.0 16V	1984.01	1992.12	104	141	-	8	1/8	AM91	AMU91		JM5365	1	VIN (E), VIN (F), VIN (M)	
5.4 V8 SOHC	2006.01	2008.12	-	-	-	8	-	-	-		JM5089	8	JM1197; VIN (5)	
6.6 16V	1977.01	1977.12	119	162	-	8		X	X		JM5365	1	VIN (A)	
7.5 16V	1977.01	1977.12	155	211	-	8		X	X		JM5365	1	VIN (S)	
<b>MKS</b>														
3.7	2008.09	2011.12	205	279	-	6	-	-	-		JM5498	6	VIN (R)	
3.7 AWD	2008.09	2011.12	205	279	-	6	-	-	-		JM5498	6	VIN (R)	
3.7	2008.09	2011.12	227	309	-	6	-	-	-		JM5498	6	VIN (R)	
3.7 AWD	2008.09	2011.12	227	309	-	6	-	-	-		JM5498	6	VIN (R)	
<b>MKT</b>														
3.7	2009.09	-->	201	274	-	6	-	-	-		JM5498	6	VIN (R)	
3.7 AWD	2009.09	-->	201	274	-	6	-	-	-		JM5498	6	VIN (R)	
3.7	2009.09	-->	226	307	-	6	-	-	-		JM5498	6	VIN (R)	
<b>MKX</b>														
3.5	2006.09	2010.12	197	269	-	6	-	-	-		JM5498	6	VIN (C)	
3.5 AWD	2006.09	2010.12	197	269	-	6	-	-	-		JM5498	6	VIN (C)	
3.7	2010.09	2011.12	227	305	-	6	-	-	-		JM5498	6		
3.7 AWD	2010.09	2011.12	227	305	-	6	-	-	-		JM5498	6		
<b>MKZ</b>														
2.5 Hybrid	2010.09	2012.12	116	156	-	4	-	-	-		JM5617	4	VIN (3) GREY ign.coil boots	
3.5	2006.09	2010.12	196	267	-	6	-	-	-		JM5498	6	VIN (T), VIN (C)	
3.5 AWD	2006.09	2010.12	196	267	-	6	-	-	-		JM5498	6	VIN (T), VIN (C)	
<b>NAVIGATOR</b>														
5.4	1997.09	1999.12	172	234	-	8	-	-	-		JM5076	8	JM1190 VIN (L); SOHC	
5.4 4WD	1997.09	1999.12	172	234	-	8	-	-	-		JM5076	8	JM1190; VIN (L); SOHC	
5.4	1998.09	2004.12	194	264	-	8	-	-	-		JM5088	8	JM1193; VIN (A); DOHC	
5.4 4WD	1998.09	2004.12	194	264	-	8	-	-	-		JM5088	8	JM1193; VIN (A); DOHC	
5.4	2004.09	2006.12	224	305	-	8	-	-	-		JM5089	8	JM1197; VIN (5)	
5.4 4WD	2004.09	2006.12	224	305	-	8	-	-	-		JM5089	8	JM1197; VIN (5)	
5.4 V8 SOHC	2005.01	-->	-	-	-	8	-	-	-		JM5089	8	JM1197; VIN (5)	
<b>TOWN CAR</b>														
4.6	1998.01	2003.12	142	190	-	8	-	-	-		JM5076	8	JM1190; VIN (W)	
4.6	2002.09	2006.12	142	190	-	8	-	-	-		JM5076	8	JM1190; VIN (W)	
4.6	2007.09	2008.12	167	227	-	8	-	-	-		JM5076	8	JM1190 VIN (W), VIN (V)	
4.6 Flexfuel	2007.09	2008.12	167	227	-	8	-	-	-		JM5076	8	JM1190 VIN (W), VIN (V)	
4.6	2007.09	2008.12	178	239	-	8	-	-	-		JM5076	8	JM1190 VIN (W), VIN (V)	
4.6 Flexfuel	2007.09	2008.12	178	239	-	8	-	-	-		JM5076	8	JM1190 VIN (W), VIN (V)	
4.6 V8 SOHC	1999.01	2000.12	142	193	-	8	-	-	-		JM5076	8	JM1190; VIN (W)	
5.0	1981.09	1985.12	104	140	-	8	1/8	AM91	AMU91		JM5622	1		
5.0 16V	1984.01	1990.12	97	132	-	8		X	X		JM5365	1	VIN (F)	
5.0 16V	1990.01	1990.12	112	152	-	8		X	X		JM5365	1	VIN (F)	
<b>TOWN CAR</b>														
4.6 V8 SOHC	1998.01	2008.12	142	193	-	8	-	-	-		JM5076	8	JM1190; VIN (W)	
4.6 V8 SOHC	2004.01	-->	178	242	-	8	-	-	-		JM5076	8	JM1190; VIN (W)	
4.6 V8 SOHC	2006.01	2009.12	167	227	-	8	-	-	-		JM5076	8	JM1190; VIN (V)	
<b>VERSAILLES</b>														
5.0 16V	1977.01	1977.12	97	132	-	8		X	X		JM5365	1	VIN (F)	
5.8 16V	1977.01	1977.12	101	137	-	8		X	X		JM5365	1	VIN (H)	
<b>ZEPHYR</b>														
3.0 AWD	2005.09	2006.12	165	224	-	6	-	-	-		JM5600	6	VIN (1); 2967cc	
3.0	2005.09	2006.12	165	224	-	6	-	-	-		JM5600	6	VIN (1); 2999cc	



<b>MAZDA USA</b>											
<b>3</b>											
2.0 16V	2004.01	2005.12	110	150	-	4	-	-	-	JM5059	4
2.0 DOHC	2004.01	-->	-	-	-	4	-	-	-	JM5059	4
2.3 16V	2004.01	2005.12	119	162	-	4	-	-	-	JM5059	4
2.3 DOHC	2004.01	-->	-	-	-	4	-	-	-	JM5059	4
<b>6</b>											
2.3 DOHC	2003.01	-->	-	-	-	4		X	X	JM5091	1
2.3 DOHC	2005.01	-->	-	-	-	4	-	-	-	JM5059	4
3.0	2002.09	2006.12	160	218	-	6	-	-	-	JM5293	6
3.0	2007.09	2008.12	158	212	-	6	-	-	-	JM5293	6
<b>323</b>											
1.6 8V	1986.01	1994.12	61	83	-	4		X	X	JM5337	4
1.6	1992.01	1994.12	-	-	-	4		X	X	JM5337	4
1.8	1990.01	1991.12	-	-	-	4		X	X	JM5337	4 Canada
<b>618</b>											
1.8	1971.09	1972.12	55	74	-	4		X	X	JM5355	1
<b>626</b>											
2.0 16V	1993.01	1997.12	85	116	-	4		X	X	JM5302	1
2.0 16V	1993.01	1997.12	85	116	-	4		X	X	JM5365	1 ATM
2.5 24V	1993.01	1997.12	122	166	-	6		X	X	JM5304	1
<b>B-series (B2200, B2300, B2600, B3000)</b>											
2.2 8V	1990.01	1993.12	63	86	-	4		X	X	JM5337	1
2.3 DOHC	2001.01	2001.12	-	-	-	4		X	X	JM5091	1 VIN (D)
2.3 DOHC	2002.01	2008.12	-	-	-	4		X	X	JM5091	1 VIN (D)
2.6 12V	1990.01	1993.12	90	122	-	4		X	X	JM5337	1
3.0 18V	1993.09	1994.12	108	147	-	6		X	X	JM5365	1 VIN (U)
3.0 18V	1995.01	1996.12	108	147	-	6		X	X	JM5073	1 VIN (U); Vertical coil connector plug
3.0 18V	1995.01	1996.12	108	147	-	6		X	X	JM5074	1 VIN (U); Horizontal coil connector plug
3.0	1996.09	1997.12	108	147	-	6		X	X	JM5073	1 VIN (U); Vertical coil connector plug
3.0	1996.09	1997.12	108	147	-	6		X	X	JM5074	1 VIN (U); Horizontal coil connector plug
3.0 12V	1997.09	2000.12	110	150		6		X	X	JM5073	1 VIN (U), VIN (V); Vertical coil connector plug
3.0 12V	1998.01	2000.12	110	150		6		X	X	JM5075	1 VIN (U), VIN (V); Vertical coil connector plug
3.0 12V	1998.01	2004.12	110	150		6		X	X	JM5075	1
3.0 12V	2001.01	2004.12	110	150		6		X	X	JM5075	1 VIN (U), VIN (V) Horizontal coil connector plug
3.0 12V	2001.01	2006.12	110	150		6		X	X	JM5075	1 VIN (U), VIN (V) Horizontal coil connector plug
3.0	2006.09	2007.12	115	154	-	6		X	X	JM5075	1
<b>CX-9</b>											
3.5	2006.09	2007.12	204	277	-	6	-	-	-	JM5498	6
3.7	2007.09	2010.12	204	277	-	6	-	-	-	JM5498	6 VIN (A), VIN (V)
<b>MIATA</b>											
1.6 16V	1990.01	1993.12	78	106	-	4		X	X	JM5325	1
1.8 16V	1995.04	1997.12	96	131	-	4		X	X	JM5325	1 4-PINS
1.8 16V	1995.04	1997.12	96	131	-	4		X	X	JM5342	1 3-PINS
<b>MPV</b>											
2.5	1999.09	2000.10	127	173	-	6		X	X	JM5073	1 VIN <177800 OE GY01-18-100
2.5	2000.10	2001.12	127	173	-	6		X	X	JM5075	1 VIN 177801> OE GY07-18-100
3.0	2001.09	2003.12	169	227	-	6	-	-	-	JM5293	6
3.0	2003.09	2006.12	169	227	-	6	-	-	-	JM5293	6
<b>MX-3</b>											
1.6 16V	1992.01	1993.12	66	90	-	4		X	X	JM5337	1
1.8	1992.01	1993.12	97	132	-	6		X	X	JM5337	1
1.8	1992.01	1993.12	97	132	-	6		X	X	JM5304	1
1.8 24V	1992.01	1994.12	97	132	-	6		X	X	JM5337	1
1.8 24V	1992.01	1994.12	97	132	-	6		X	X	JM5304	1
<b>MX-6</b>											
2.0 16V	1993.01	1997.12	85	116	-	4		X	X	JM5365	1 ATM
2.0 16V	1993.01	1997.12	85	116	-	4		X	X	JM5302	1
2.5 24V	1993.01	1997.12	122	166	-	6		X	X	JM5304	1



MAZDA USA												
<b>PROTEGE</b>												
1.6	1998.09	2001.12	78	106	-		4		X	X	JM5453	2 OE ZM01-18-100
1.8 16V	1990.01	2000.12	77	105	-		4 -/4	JP157	JPE157	JM5345	1	
1.8	1990.01	1995.12	-	-	-		4		X	X	JM5337	1
2.0 DOHC	2001.01	-->	-	-	-		4		X	X	JM5064	2
2.0 DOHC	2002.01	2003.12	-	-	-		4		X	X	JM5064	2
2.0 TURBO DOHC	2003.01	-->	-	-	-		4		X	X	JM5064	2
<b>RX-7</b>												
1.1	1978.09	1979.12	101	137	-		2		X	X	JM5355	1
<b>RX-8</b>												
1.3	2003.09	2006.12	147	200	-		2		X	X	JM5459	4
1.3	2006.09	2010.12	158	212	-		2		X	X	JM5459	4
1.3	2007.09	2011.12	173	232	-		2		X	X	JM5459	4
<b>TRIBUTE</b>												
2.0 DOHC	2001.01	2003.12	-	-	-		4		X	X	JM5091	1
2.3 16V	2005.01	2006.12	114	155	-		4 -	-	-	-	JM5059	4 VIN (Z)
2.3 DOHC	2005.01	2008.12	-	-	-		4 -	-	-	-	JM5059	4 VIN (Z)
2.3 DOHC ELECTRIC/GAS	2008.01	-->	-	-	-		4 -	-	-	-	JM5059	4 VIN (H)
2.5 4WD	2008.09	2011.12	116	156	-		4 -	-	-	-	JM5617	4 VIN (7) GREY ign.coil boots
2.5	2008.09	2011.12	127	171	-		4 -	-	-	-	JM5617	4 VIN (7) GREY ign.coil boots
2.5 Hybrid 4WD	2008.09	2010.12	132	177	-		4 -	-	-	-	JM5617	4 VIN (7) GREY ign.coil boots
2.5 Hybrid 4WD	2008.09	2010.12	132	177	-		4 -	-	-	-	JM5600	4 VIN (3)
2.5 Hybrid	2008.09	2010.12	132	177	-		4 -	-	-	-	JM5617	4 VIN (7) GREY ign.coil boots
2.5 Hybrid	2008.09	2010.12	132	177	-		4 -	-	-	-	JM5600	4 VIN (3)
2.5 4WD	2010.01	2011.12	116	156	-		4 -	-	-	-	JM5617	4 VIN (3) GREY ign.coil boots
2.5	2010.01	2011.12	127	171	-		4 -	-	-	-	JM5617	4 VIN (3) GREY ign.coil boots
2.5 Hybrid 4WD	2010.01	2010.12	132	177	-		4 -	-	-	-	JM5617	4 VIN (3) GREY ign.coil boots
2.5 Hybrid	2010.01	2010.12	132	177	-		4 -	-	-	-	JM5617	4 VIN (3) GREY ign.coil boots
3.0 24V	2001.01	2004.12	149	203	-		6 -	-	-	-	JM5340	6 VIN (1)
3.0 24V AWD	2005.01	2006.12	149	203	-		6 -	-	-	-	JM5340	6 VIN (1)
3.0	2007.09	2008.12	149	203	-		6 -	-	-	-	JM5600	6 VIN (1)
3.0 4WD	2007.09	2008.12	149	203	-		6 -	-	-	-	JM5600	6 VIN (1)
3.0 4WD	2008.09	2009.12	179	240	-		6 -	-	-	-	JM5600	6 VIN (1)
3.0 FLEX 4WD	2009.09	-->	179	240	-		6 -	-	-	-	JM5600	6 VIN (G)
<b>MERCEDES USA</b>												
<b>200</b>												
2.0	1965.09	1967.12	78	105	-		4		X	X	JM5355	1
<b>220</b>												
2.2	1968.01	1970.12	-	-	-		4		X	X	JM5355	1
2.3 S / SE	1966.01	1966.12	-	-	-		6		X	X	JM5355	1
<b>230</b>												
2.3	1965.09	1969.12	88	118	-		6		X	X	JM5355	1
2.3 S	1966.01	1969.12	-	-	-		6		X	X	JM5355	1
2.3 SL	1962.09	1967.12	-	-	-		6		X	X	JM5355	1
<b>250</b>												
2.5 S	1966.01	1968.12	-	-	-		6		X	X	JM5355	1
2.5 SE	1966.01	1968.12	-	-	-		6		X	X	JM5355	1
2.5 SEC	1966.01	1968.12	-	-	-		6		X	X	JM5355	1
2.5 SL	1966.01	1968.12	-	-	-		6		X	X	JM5355	1
2.5	1968.01	1968.12	-	-	-		6		X	X	JM5355	1
<b>280</b>												
2.8 SL	1967.09	1969.12	134	180	-		6		X	X	JM5355	1 Carb.
2.8 SL	1967.09	1969.12	134	180	-		6		X	X	JM5355	1 Inj.
<b>300</b>												
3.0	1959.09	1959.12	-	-	183cid L6		6		X	X	JM5355	1
3.0	1961.01	1961.12	-	-	183cid L6		6		X	X	JM5210	1 w / internal resistor
3.0	1961.01	1961.12	-	-	183cid L6		6		X	X	JM5355	1 w / external resistor
3.0	1962.01	1962.12	-	-	183cid L6		6		X	X	JM5355	1



## MERCEDES USA

C-CLASS												
C63 6.2 AMG	2007.09	2011.12	336	451	-	8	-	-	-	JM5615	8	
CL												
CL63 6.2 AMG	2008.01	2010.12	-	-	-	8	-	-	-	JM5615	8	
CL600 6.0	1998.01	1999.12	290	389	-	12	-	-	-	JM5356	12	
CLK												
CLK63 6.2 AMG	2006.09	2007.12	354	475	-	8	-	-	-	JM5615	8	
CLS												
CLS63 6.2 AMG	2006.09	2010.12	378	507	-	8	-	-	-	JM5615	8	
E-CLASS												
CLS63 6.2 AMG	2010.09	-->	378	507	-	8	-	-	-	JM5615	8	
E63 6.2 AMG	2010.09	2011.12	336	451	-	8	-	-	-	JM5615	8	
E63 6.2 AMG	2008.09	2009.12	378	507	-	8	-	-	-	JM5615	8	
E420 4.2	1997.01	1997.12	205	279	-	8	-	-	-	JM5356	8	
FINTAIL												
300 2.8 SEL	1967.09	1969.12	134	180	-	6		X	X	JM5355	1	
300 3.0 SE	1961.01	1964.12	138	185	-	6		X	X	JM5210	1	w / internal resistor; Inj.
300 3.0 SE	1961.01	1964.12	138	185	-	6		X	X	JM5355	1	w / external resistor; Inj.
300 3.0 SE	1961.01	1964.12	138	185	-	6		X	X	JM5210	1	w / internal resistor Carb.
300 3.0 SE	1961.01	1964.12	138	185	-	6		X	X	JM5355	1	w / external resistor Carb.
300 3.0 SEL	1962.09	1965.12	145	195	-	6		X	X	JM5210	1	w / internal resistor
300 3.0 SEL	1962.09	1965.12	145	195	-	6		X	X	JM5355	1	w / external resistor
300 3.0 SE	1966.01	1966.12	138	185	-	6		X	X	JM5355	1	Inj.
300 3.0 SE	1966.01	1966.12	138	185	-	6		X	X	JM5355	1	Carb.
GULLWING												
300 3.0 SL	1958.01	1958.12	179	240	-	6		X	X	JM5355	1	w / external resistor
300 3.0 SL	1961.01	1961.12	186	250	-	6		X	X	JM5355	1	w / internal resistor; Inj.
300 3.0 SL	1961.01	1963.12	186	250	-	6		X	X	JM5355	1	w / external resistor; Inj.
300 3.0 SL	1963.01	1963.12	186	250	-	6		X	X	JM5210	1	w / internal resistor Carb.
300 3.0 SL	1963.01	1963.12	186	250	-	6		X	X	JM5355	1	w / external resistor Carb.
M-CLASS												
ML63 6.2 AMG 4-matic	2006.09	2011.12	375	503	-	8	-	-	-	JM5615	8	
PONTON												
220 2.2	1967.09	1970.12	63	84	-	4		X	X	JM5355	1	
PULLMAN												
600 6.3	1963.09	1972.12	201	270	-	6		X	X	JM5355	1	Carb.
600 6.3	1963.09	1972.12	201	270	-	6		X	X	JM5355	1	Inj.
R-CLASS												
R63 6.2 AMG 4-matic	2006.09	2007.12	375	503	-	8	-	-	-	JM5615	8	
S-CLASS												
CL63 .2 AMG	2007.09	2010.12	386	518	-	8	-	-	-	JM5615	8	
S250 2.5 S	1965.09	1967.12	-	-	-	6		X	X	JM5355	1	
S250 2.5 SL	1965.09	1967.12	-	-	-	6		X	X	JM5355	1	
S280 2.8 S	1967.09	1969.12	117	157	-	6		X	X	JM5355	1	
S280 2.8 SE	1967.09	1969.12	131	176	-	6		X	X	JM5355	1	
S280 2.8 SEL	1967.09	1969.12	134	180	-	6		X	X	JM5355	1	
S300 3.0 SEL	1962.09	1965.12	145	195	-	6		X	X	JM5210	1	w / internal resistor
S300 3.0 SEL	1962.09	1965.12	145	195	-	6		X	X	JM5355	1	w / external resistor
S500 5.0	1996.01	1999.12	235	315	-	8	-	-	-	JM5356	8	
S600 6.0	1996.01	1999.12	290	389	-	12	-	-	-	JM5356	12	
SL												
SL63 6.2 AMG	2009.09	-->	387	518	-	8	-	-	-	JM5615	8	
SL63 6.2 AMG	2008.09	2011.12	391	531	-	8	-	-	-	JM5615	8	
SL500 5.0	1997.01	1998.12	235	315	-	8	-	-	-	JM5356	8	
SL600 6.0	1996.01	2002.12	290	389	-	12	-	-	-	JM5356	12	
SLS-CLASS												
SLS63 6.2 AMG	2011.06	-->	419	570	-	8	-	-	-	JM5615	8	

## MERCURY

COLONY PARK												
5.0 V8	-->	1991.12	-	-	-	8	2/8	AM39	AMU39	X	-	
COUGAR												
3.8 V6	1990.01	1996.12	-	-	-	6	-/6	AM20	AMU20	X	-	



													<b>MERCURY</b>	
<b>GRAND MARQUIS</b>														
4.6	1998.01	1999.09	157	213	-		8	-	-	-	JM5076	8	JM1190; VIN (W)	
4.6 GS	1999.10	2011.12	167	227	-		8	-	-	-	JM5076	8	JM1190 VIN (W), VIN (N)	
4.6 LS	1999.10	2011.12	178	242	-		8	-	-	-	JM5076	8	JM1190 VIN (W), VIN (N)	
5.0 V8	-->	1991.12	-	-	-		8	2/8	AM39	AMU39	X	-		
<b>MARINER</b>														
3.0 4WD	2004.05	2006.12	151	205	-		6	-	-	-	JM5340	6	VIN (1)	
3.0 4WD	2007.01	2007.12	151	205	-		6	-	-	-	JM5600	6	VIN (1)	
<b>MONTEGO</b>														
3.0 SE	2005.01	2007.12	151	205	-		6	-	-	-	JM5340	6	VIN (1)	
<b>MOUNTAINEER</b>														
4.6	2002.01	2006.12	178	242	-		8	-	-	-	JM5076	8	JM1190; VIN (W)	
4.6	2005.09	2006.12	215	292	-		8	-	-	-	JM5076	8	JM1190; VIN (8)	
4.6	2007.01	-->	215	292	-		8	-	-	-	JM5089	8	JM1197; VIN (8)	
<b>MYSTIQUE</b>														
2.5	1994.09	2000.12	125	169	-		6		X	X	JM5073	1	VIN (L)	
2.5	1994.09	1997.08	127	173	-		6		X	X	JM5073	1	VIN (L)	
<b>SABLE</b>														
3.0 V6	-->	1990.12	-	-	-		6	1/6	AM6	AMU6	X	-		
3.0	2001.01	2005.05	145	197	-		6		X	X	JM5075	1		
<b>TOPAZ</b>														
3.0 V6	1992.01	1994.12	97	131	-		6	1/6	AM6	AMU6	X	-		
<b>VILLAGER</b>														
3.0 V6	1994.01	1995.12	113	153	-		6	1/6	JP140	JPE140	JM5135	1		
3.0 V8	1994.01	1995.12	113	153	-		8	2/8	AM41	AMU41	X	-		
													<b>MERCURY USA</b>	
<b>CAPRI</b>														
2.3	1983.01	1986.12	-	-	140cid.		4		X	X	JM5365	1	VIN (A), VIN (W)	
3.8 V6	1984.01	1986.12	-	-	232cid.		6		X	X	JM5365	1	VIN (3)	
5.0 V8	1984.01	1986.12	-	-	302cid.		8		X	X	JM5365	1	VIN (F), VIN (M)	
<b>COLONY PARK</b>														
5.0	1987.01	1991.12	112	152	302cid.		8	1/8	AM91	AMU91	JM5365	1	VIN (F)	
<b>COUGAR</b>														
2.5	1999.01	2000.12	-	-	-		6		X	X	JM5073	1		
2.5	2001.01	2002.12	-	-	-		6		X	X	JM5075	1		
3.8	1987.09	1989.12	66	89	-		6		X	X	JM5365	1	VIN (4)	
3.8	1990.01	1990.12	66	89	-		6		X	X	JM5365	1	VIN (4)	
3.8	1990.01	1990.12	66	89	-		6		X	X	JM5073	1	VIN (R)	
3.8	1994.01	1994.12	66	89	-		6		X	X	JM5365	1	Exc. California	
3.8	1994.01	1994.12	66	89	-		6		X	X	JM5073	1	California	
3.8	2005.01	1997.12	66	89	-		6		X	X	JM5073	1	VIN (4)	
<b>GRAND MARQUIS</b>														
4.6	1996.09	2001.12	149	200	-		8	-	-	-	JM5076	8	JM1190; VIN (W)	
4.6 V8 SOHC	1998.01	2005.12	-	-	-		8	-	-	-	JM5076	8	JM1190; VIN (W)	
4.6	2001.09	2008.12	167	224	-		8	-	-	-	JM5076	8	JM1190; VIN (W)	
4.6 Flexfuel	2001.09	2008.12	167	224	-		8	-	-	-	JM5076	8	JM1190; VIN (W)	
4.6	2006.01	2008.12	167	224	-		8	-	-	-	JM5076	8	JM1190; VIN (V)	
4.6 V8 SOHC	2006.01	2008.12	-	-	-		8	-	-	-	JM5076	8	JM1190; VIN (V)	
4.6 V8 SOHC	2006.01	2009.12	-	-	-		8	-	-	-	JM5076	8	JM1190; VIN (V)	
4.6 FLEX	2010.09	2011.12	167	224	-		8	-	-	-	JM5076	8	JM1190; VIN (V)	
5.0	1986.09	1991.12	112	152	-		8	1/8	AM91	AMU91	X	-		
<b>MARAUDER</b>														
4.6	2002.09	2004.12	225	305	-		8	-	-	-	JM5088	8	JM1193; VIN (V)	
4.6 V8 DOHC	2003.01	2004.12	-	-	-		8	-	-	-	JM5076	2	JM1190; 1-2 cyl. VIN (V)	
4.6 V8 DOHC	2003.01	2004.12	-	-	-		8		X	X	JM5088	6	JM1193; 3-4-5-6-7-8 cyl.; VIN (V)	
<b>MARINER</b>														
2.3	2005.01	2008.12	-	-	-		4	-	-	-	JM5059	4	VIN (H), VIN (Z)	
2.3 DOHC	2005.01	2008.12	-	-	-		4		X	X	JM5059	4	VIN (Z)	
2.3 4x4	2006.01	2008.12	-	-	-		4	-	-	-	JM5059	4	VIN (H), VIN (Z)	
2.3 DOHC	2006.01	2007.12	-	-	-		4		X	X	JM5059	4	VIN (Z)	
2.3 DOHC ELECTRIC/GAS	2006.01	2008.12	-	-	-		4		X	X	JM5059	4	VIN (H)	
2.3	2007.01	2008.12	-	-	-		4	-	-	-	JM5059	4	VIN (H), VIN (Z)	



## MERCURY USA

### MARINER

2.5 Hybrid	2008.09	2010.12	128	171	-	4	-	-	-	JM5617	4	VIN (3), VIN (7) GREY ign.coil boots
2.5 Hybrid	2008.09	2010.12	132	177	-	4	-	-	-	JM5617	4	VIN (3), VIN (7) GREY ign.coil boots
2.5 Hybrid 4WD	2010.09	-->	127	171	-	4	-	-	-	JM5617	4	VIN (3), VIN (7) GREY ign.coil boots
3.0 4x4	2004.09	2007.12	180	244	-	6	-	-	-	JM5340	6	VIN (1) OE 1L8Z-12029-AB
3.0 4x4	2004.09	2007.12	180	244	-	6	-	-	-	JM5600	6	VIN (1) OE 6E5Z-12029-BA
3.0 AWD	2004.09	2005.12	150	203	-	6	-	-	-	JM5340	6	VIN (1)
3.0	2005.01	2006.12	-	-	-	6	-	-	-	JM5340	6	VIN (1)
3.0	2005.09	2006.12	149	200	-	6	-	X	X	JM5340	6	VIN (1)
3.0 AWD	2008.09	2009.12	180	244	-	6	-	-	-	JM5600	6	VIN (G)
3.0 FLEX	2010.09	-->	179	240	-	6	-	X	X	JM5600	6	VIN (G)

### MILAN

2.3	2005.09	2009.12	119	161	-	4	-	-	-	JM5610	4	VIN (Z) OE 6E5Z12029AA
2.3 AWD	2006.09	2009.12	119	161	-	4	-	-	-	JM5610	4	VIN (Z) OE 6E5Z12029AA
2.5	2009.09	2010.12	116	157	-	4	-	-	-	JM5617	4	VIN (3), VIN (A) GREY ign.coil boots
2.5 Hybrid	2010.09	-->	116	156	-	4	-	-	-	JM5617	4	VIN (3), VIN (A) GREY ign.coil boots
2.5	2010.09	-->	131	175	-	4	-	-	-	JM5617	4	VIN (3), VIN (A) GREY ign.coil boots
3.0	2005.09	2010.12	165	224	-	6	-	-	-	JM5600	6	VIN (1), VIN (G)
3.0 Flexfuel	2005.09	2010.12	179	243	-	6	-	-	-	JM5600	6	VIN (1), VIN (G)
3.0 AWD	2006.09	2010.12	165	224	-	6	-	-	-	JM5600	6	VIN (1), VIN (G)
3.0 Flexfuel AWD	2006.09	2010.12	179	243	-	6	-	-	-	JM5600	6	VIN (1), VIN (G)
3.0 FLEX	2010.09	-->	179	243	-	6	-	X	X	JM5600	6	VIN (G)

### MONTEGO

3.0	2005.01	2007.12	-	-	-	6	-	-	-	JM5340	6	VIN (1)
3.0	2005.01	2005.12	169	227	-	6	-	-	-	JM5340	6	VIN (1)
3.0	2006.01	2007.12	-	-	-	6	-	-	-	JM5340	6	VIN (1)

### MONTEREY

4.2	2004.01	2007.12				6	-	X	X	JM5075	1	
-----	---------	---------	--	--	--	---	---	---	---	--------	---	--

### MOUNTAINEER

4.6	2001.09	2005.12	156	212	-	8	-	-	-	JM5076	8	JM1190; VIN (W)
4.6 V8 SOHC	2002.01	2005.12	-	-	-	8	-	-	-	JM5076	8	JM1190; VIN (V)
4.6 V8 SOHC	2004.01	-->	-	-	-	8	-	-	-	JM5076	8	JM1190; VIW (W)
4.6	2005.09	2006.12	217	296	-	8	-	-	-	JM5076	8	JM1190
4.6 V8 SOHC	2006.01	-->	-	-	-	8	-	-	-	JM5076	8	JM1190; VIN (8)
4.6 V8 SOHC	2006.01	2006.12	-	-	-	8	-	-	-	JM5076	8	JM1190; VIN (8)
4.6 V8 SOHC	2007.01	-->	-	-	-	8	-	-	-	JM5089	8	JM1197; VIN (8)
4.6	2007.12	2010.12	217	296	-	8	-	-	-	JM5089	8	JM1197
4.6 V8 SOHC	2008.01	-->	-	-	-	8	-	-	-	JM5089	8	JM1197; VIN (8)
5.0	1996.09	2001.12	160	217	-	8	-/8	AM95	AMU95	JM5032	2	

### SABLE

3.0	1986.01	1995.12	-	-	182cid.	6	-	X	X	X	1	VIN (U)
3.0	1995.09	1999.12	108	145	-	6	-	X	X	JM5073	1	VIN (U); OHV
3.0	1995.09	2000.12	149	200	-	6	-	X	X	JM5073	1	VIN (S); DOHC
3.0	1996.01	2000.12	-	-	-	6	-	X	X	JM5073	1	VIN (U); OHV
3.0	1996.01	1999.12	-	-	-	6	-	X	X	JM5073	1	VIN (S); DOHC
3.0	1999.09	2000.12	114	153	-	6	-	X	X	JM5073	1	VIN (S); DOHC
3.0	1999.09	2000.12	116	155	-	6	-	X	X	JM5073	1	VIN (U); OHV
3.0	2000.01	2000.12	114	153	-	6	-	X	X	JM5340	6	VIN (S); DOHC
3.0	2000.01	2000.12	149	200	-	6	-	X	X	JM5340	6	VIN (S); DOHC
3.0	2000.01	2000.12	-	-	-	6	-	-	-	JM5340	6	VIN (S); DOHC
3.0 Flexfuel	2000.09	2003.12	149	200	-	6	-	X	X	JM5075	1	VIN (S); DOHC
3.0	2001.01	2003.12	149	200	-	6	-	X	X	JM5075	1	VIN (S); DOHC
3.0	2001.01	2005.12	-	-	-	6	-	X	X	JM5075	1	VIN (U); OHV
3.0	2001.01	2001.12	-	-	-	6	-	X	X	JM5075	1	VIN (2); FLEX OHV
3.0	2001.01	2003.12	-	-	-	6	-	X	X	JM5075	1	VIN (S); DOHC
3.0	2001.01	2005.12	-	-	-	6	-	X	X	JM5075	1	
3.0	2002.01	2004.12	-	-	-	6	-	X	X	JM5075	1	
3.0	2003.01	2005.12	-	-	-	6	-	X	X	JM5075	1	VIN (2); FLEX OHV
3.0	2004.01	2004.12	149	200	-	6	-	X	X	JM5340	6	VIN (S); DOHC
3.0 Flexfuel	2004.01	2004.12	149	200	-	6	-	X	X	JM5340	6	VIN (S); DOHC





**MERCURY USA**

<b>SABLE</b>												
3.0	2004.01	2004.12	-	-	-	6	-	-	-	-	JM5340	6 VIN (S); DOHC
3.0	2005.01	2005.12	149	200	-	6		X	X	JM5293	6 VIN (S); DOHC	
3.0 Flexfuel	2005.01	2005.12	149	200	-	6		X	X	JM5293	6 VIN (S); DOHC	
3.0	2005.01	2005.12	-	-	-	6	-	-	-	JM5293	6 VIN (S); DOHC	
3.5	2007.09	2009.12	196	266	-	6	-	-	-	JM5498	6 VIN (W)	
<b>TRACER</b>												
1.8	1991.01	1996.12	-	-	-	4		X	X	JM5337	1 VIN (8)	
<b>VILLAGER</b>												
3.3	1999.01	2002.12	-	-	VG33E	6		X	X	JM5319	1	

**MG USA**

<b>1100</b>												
1.1	1963.01	1967.12	-	-	-	4		X	X	JM5455	1 + resistor	
<b>MGA</b>												
1.5	1955.09	1959.12	75	100	-	4		X	X	JM5455	1 + resistor	
1.6	1959.09	1962.12	67	90	-	4		X	X	JM5455	1 + resistor	
<b>MGB</b>												
1.8	1967.09	1974.12	69	92	-	4		X	X	JM5455	1 + resistor	
1.8	1968.01	1981.12	-	-	-	4		X	X	JM5334	1 GT40RT	
1.8	1974.09	1980.12	62	85	-	4		X	X	JM5455	1 + resistor	
1.8	1974.09	1980.12	62	85	-	4		X	X	JM5334	1 GT40RT	
1.8	1976.01	1980.12	62	85	-	4		X	X	JM5355	1 VIN (H), VIN (J)	
1.8	1980.09	1981.12	47	63	-	4		X	X	JM5355	1 VIN (J)	
3.5 8V	1974.09	1977.12	102	139	-	8		X	X	JM5355	1 VIN (1)	
<b>MIDGET</b>												
1.5	1974.09	1979.12	48	65	-	4		X	X	JM5355	1 VIN (A)	

**MINI USA**

<b>COOPER</b>												
1.6 DOHC	01.2002	12.2008	-	-	N12 B12 A	4		X	X	JM5070	1	
1.6 TURBO DOHC	01.2007	-->	-	-	N14 B12 A	4		X	X	JM5070	1	
1.6 DOHC	01.2008	-->	-	-	N12 B12 A	4		X	X	JM5070	1	

**MITSUBISHI USA**

<b>3000 GT</b>												
3.0 24V	1991.01	1992.12	120	163	-	6		X	X	JM5327	3 VIN (B)	
3.0 24V Turbocharged	1991.01	1992.12	224	305	-	6		X	X	JM5327	3 VIN (C)	
3.0 24V	1993.01	1996.12	120	163	-	6		X	X	JM5327	3 VIN (J)	
3.0 24V Turbocharged	1993.01	1996.12	224	305	-	6		X	X	JM5327	3 VIN (K)	
3.0 24V	1997.01	1999.12	120	163	-	6		X	X	JM5327	1 VIN (J)	
3.0 12V	1997.01	1999.12	120	163	-	6		X	X	JM5104	1 VIN (H)	
3.0 24V Turbocharged	1997.01	1999.12	224	305	-	6		X	X	JM5327	3 VIN (K)	
<b>DIAMANTE</b>												
3.0 24V	1992.01	1995.12	131	178	-	6		X	X	JM5327	3 VIN (J)	
3.0 12V	1992.01	1996.12	131	178	-	6		X	X	JM5104	1 VIN (H), VIN (S)	
<b>ECLIPSE</b>												
1.8 L4 MFI 107 cid	1990.01	1994.12	-	-	107cid.	4		X	X	JM5198	1	
2.0 16V	1990.01	1994.12	101	137	-	4	-/4	JP107	JPE107	JM5326	2 VIN (E), VIN (R)	
2.0 16V	1990.01	1990.12	101	137	-	4		X	X	JM5161	1 VIN (U), VIN (R); set coil	
2.0 16V	1990.01	1994.12	101	137	-	4		X	X	JM5326	1 VIN (U), VIN (R) single coil	
2.0 16V	1990.01	1997.12	101	137	-	4		X	X	JM5070	1 VIN (Y)	
2.0 16V AWD	1991.01	1994.12	134	182	-	4	-/4	JP107	JPE107	JM5326	2	
2.0 16V	1995.01	1996.12	101	137	-	4		X	X	JM5071	1 VIN (Y)	
2.0 16V AWD	1995.01	1997.12	134	182	-	4	-/4	JP107	JPE107	JM5327	2 w / Turbo	
2.0 DOHC 122 cid.	1995.01	1996.12	-	-	122cid.	4		X	X	JM5071	1 VIN (Y)	
2.0 16V	1996.01	1999.12	157	214	-	4		X	X	JM5327	2 VIN (F); w / Turbo	
2.0 16V	1996.01	1996.12	-	-	-	4		X	X	JM5071	1 VIN (Y)	
2.0 16V	1996.01	1997.12	-	-	-	4		X	X	JM5327	2 VIN (F); Turbocharged	
2.0 DOHC 122 cid.	1996.01	1997.12	-	-	420A	4		X	X	JM5070	1 VIN (Y)	
2.0 DOHC 122 cid.	1996.01	1998.12	-	-	420A	4		X	X	JM5070	1 VIN (Y)	
2.0 DOHC 122 cid.	1996.01	1998.12	-	-	420A	4		X	X	JM5070	1 VIN (Y)	
2.0 16V	1997.01	1997.12	-	-	-	4		X	X	JM5070	1 VIN (Y)	
2.4 SOHC	2000.01	-->	-	-	4G64	4	-/2	JP200	-	JM5121	2 JM1185 or JM1194 VIN (G)	
3.0 24V	2001.01	2005.12	149	203	-	6		X	X	JM5317	1	



## MITSUBISHI USA

ENDEAVOR													
3.8	2003.09	2004.12	160	218	-	6	-	-	-	-	JM5606	6	OE MN187373 OE MR984160
3.8	2004.09	2008.06	168	228	-	6	-	-	-	-	JM5606	6	OE MN187373 OE MR984160

EXPO													
1.8 L4 MFI 112 cid	1994.01	1994.12	-	-	112cid.	4		X	X		JM5198	1	
2.4	1991.09	1992.05	87	118	-	4		X	X		JM5123	1	
2.4	1992.06	1992.12	87	118	-	4		X	X		JM5302	1	
2.4	1992.06	1992.12	87	118	-	4		X	X		JM5175	1	
2.4	1992.09	1992.05	101	137	-	4		X	X		JM5302	1	
2.4	1992.09	1992.05	101	137	-	4		X	X		JM5175	1	
2.4	1995.06	1995.12	101	137	-	4		X	X		JM5313	1	

GALANT													
2.0 I VR4 Turbo AWD (E39A, E38A, E33A)	1990.10	1993.03	148	201	4 G 63 T	4	-/4	JP107	JPE107		JM5326	2	
2.4 16V	1994.01	1997.12	104	141	-	4		X	X		JM5327	2	Model GS
2.4 SOHC	1999.01	2003.12	-	-	4G64	4	-/2	JP200	-		JM5121	2	JM1185 or JM1194 VIN (G)
3.0 24V	1999.01	2003.12	146	199	-	6		X	X		JM5317	1	
3.8	2003.09	2004.12	172	234	-	6	-	-	-		JM5606	6	OE MN187373 OE MR984160
3.8	2004.09	2007.12	172	234	-	6	-	-	-		JM5606	6	OE MN187373 OE MR984160
3.8	2006.09	2007.12	193	258	-	6	-	-	-		JM5606	6	OE MN187373 OE MR984160

LANCER													
2.0 SOHC	2002.01	2004.12	-	-	-	4	-/2	JP200	-		JM5121	2	JM1185 or JM1194
2.0 Turbo DOHC	2003.01	-->	-	-	-	4		X	X		JM5122	2	JM1234
2.0 SOHC	2005.01	-->	-	-	4G94	4	-/2	JP200	-		JM5121	2	JM1185 or JM1194 VIN (E)

MIRAGE													
1.5 12V	1991.01	1997.12	69	94	-	4		X	X		JM5198	1	
1.5 12V	1993.01	1997.12	69	94	-	4		X	X		JM5198	1	
1.6 16V	1991.01	1992.12	92	125	-	4	-/4	JP107	JPE107		JM5161	1	
1.8 L4 MFI SOHC 112 cid	1993.01	1995.12	-	-	4G93	4		X	X		JM5197	1	
1.8 L4 MFI SOHC 112 cid	1995.01	1995.12	-	-	4G93	4		X	X		JM5198	1	
1.8 SOHC 112 cid.	1997.01	1998.12	-	-	4G93	4	-/2	JP200	-		JM5121	2	JM1185 or JM1194 VIN (C)
1.8 SOHC 112 cid.	1999.01	2002.12	-	-	4G93	4	-/2	JP200	-		JM5121	2	JM1185 or JM1194 VIN (C)

MONTERO													
2.4 16V	1997.01	1997.12	99	135	-	4		X	X		JM5338	1	
3.0 24V AWD	1995.01	1996.12	132	180	-	6		X	X		JM5327	3	VIN (H)
3.0	1996.09	1999.12	123	167	-	6		X	X		JM5488	1	1 & 4 cyl.; VIN (P) black connector
3.0	1996.09	1999.12	123	167	-	6		X	X		JM5488	1	2 & 5 cyl.; VIN (P) black connector
3.0	1996.09	1999.12	123	167	-	6		X	X		JM5487	1	3 & 6 cyl.; VIN (P) white connector
3.0	1998.09	1999.12	123	167	-	6		X	X		JM5488	1	1 & 4 cyl.; VIN (P) black connector
3.0	1998.09	1999.12	123	167	-	6		X	X		JM5488	1	2 & 5 cyl.; VIN (P) black connector
3.0	1998.09	1999.12	123	167	-	6		X	X		JM5487	1	3 & 6 cyl.; VIN (P) white connector
3.0	2000.01	2003.12	123	167	-	6		X	X		JM5488	1	1 & 4 cyl.; VIN (H) black connector
3.0	2000.01	2003.12	123	167	-	6		X	X		JM5488	1	2 & 5 cyl.; VIN (H) black connector
3.0	2000.01	2003.12	123	167	-	6		X	X		JM5487	1	3 & 6 cyl.; VIN (H) white connector
3.5 4WD	1993.09	1996.12	149	203	-	6	-/3	JP208	-		JM5628	3	OE MD303922
3.5 4WD	1997.01	1999.12	149	203	-	6	-/6	JP240	-		JM5488	1	1 & 4 cyl. black connector
3.5 4WD	1997.01	1999.12	149	203	-	6	-/6	JP240	-		JM5488	1	2 & 5 cyl. black connector
3.5 4WD	1997.01	1999.12	149	203	-	6	-/6	JP240	-		JM5487	1	3 & 6 cyl. white connector
3.5 4WD	1997.01	2002.12	149	203	-	6		X	X		JM5488	1	1 & 4 cyl. black connector
3.5 4WD	1997.01	2002.12	149	203	-	6		X	X		JM5488	1	2 & 5 cyl. black connector



<b>MITSUBISHI USA</b>													
<b>MONTERO</b>													
3.5 4WD	1997.01	2002.12	149	203	-		6		X	X	JM5487	1	3 & 6 cyl. white connector
3.5	1998.09	2004.12	147	200	-		6		X	X	JM5488	1	1 & 4 cyl.; VIN (R) black connector
3.5	1998.09	2004.12	147	200	-		6		X	X	JM5488	1	2 & 5 cyl.; VIN (R) black connector
3.5	1998.09	2004.12	147	200	-		6		X	X	JM5487	1	3 & 6 cyl.; VIN (R) white connector
3.5 4WD	1999.09	2002.12	149	203	-		6		X	X	JM5488	1	1 & 4 cyl.; VIN (R) black connector
3.5 4WD	1999.09	2002.12	149	203	-		6		X	X	JM5488	1	2 & 5 cyl.; VIN (R) black connector
3.5 4WD	1999.09	2002.12	149	203	-		6		X	X	JM5487	1	3 & 6 cyl.; VIN (R) white connector
3.8 4WD	2002.09	2005.12	160	218	-		6		X	X	JM5482	3	VIN (S)
<b>OUTLANDER</b>													
2.4 SOHC	2003.01	2004.12	-	-	4G93		4	-/2	JP200	-	JM5121	2	JM1185 or JM1194 VIN (C)
2.4 SOHC	2005.01	-->	-	-	4G69		4	-/2	JP200	-	JM5121	2	JM1185 or JM1194 VIN (F)
<b>RAIDER</b>													
3.7 V6 SOHC 226 cid.	2006.01	2009.12	-	-	226cid.		6		X	X	JM5286	6	VIN (K)
4.7 V8 SOHC 285 cid.	2006.01	2007.12	-	-	285cid.		8		X	X	JM5286	8	VIN (N)
<b>MORRIS USA</b>													
<b>CAMBRIDGE</b>													
1.5	1961.01	1961.12	-	-	-		4		X	X	JM5335	1	for Bosch GT40T R1=3.0[Ω], R2=8.5[kΩ]
<b>MINOR</b>													
0.8	1953.01	1956.12	-	-	-		4		X	X	JM5335	1	for Bosch GT40T R1=3.0[Ω], R2=8.5[kΩ]
0.9	1950.01	1952.12	-	-	-		4		X	X	JM5335	1	for Bosch GT40T R1=3.0[Ω], R2=8.5[kΩ]
0.9	1960.01	1971.12	-	-	-		4		X	X	JM5335	1	for Bosch GT40T R1=3.0[Ω], R2=8.5[kΩ]
1.0	1957.01	1962.12	-	-	-		4		X	X	JM5335	1	for Bosch GT40T R1=3.0[Ω], R2=8.5[kΩ]
1.0	1963.01	1971.12	-	-	-		4		X	X	JM5335	1	for Bosch GT40T R1=3.0[Ω], R2=8.5[kΩ]
1.1	1963.01	1971.12	-	-	-		4		X	X	JM5335	1	for Bosch GT40T R1=3.0[Ω], R2=8.5[kΩ]
1.3	1965.01	1971.12	-	-	-		4		X	X	JM5335	1	for Bosch GT40T R1=3.0[Ω], R2=8.5[kΩ]
<b>OXFORD</b>													
1.5	1950.01	1954.12	-	-	-		4		X	X	JM5335	1	for Bosch GT40T R1=3.0[Ω], R2=8.5[kΩ]
1.5	1960.01	1962.12	-	-	-		4		X	X	JM5335	1	for Bosch GT40T R1=3.0[Ω], R2=8.5[kΩ]
<b>NISSAN USA</b>													
<b>200 SX</b>													
1.8 Turbo	1986.01	1988.12	74	101	CA18ET		4		X	X	JM5603	2	VIN (C)
2.0	1986.01	1987.12	74	101	CA20E		4		X	X	JM5104	1	VIN (H)
2.0	1998.01	1988.12	74	101	CA20E		4		X	X	JM5603	2	VIN (P)
3.0	1986.09	1988.12	119	162	VG30E		4		X	X	JM5603	1	VIN (H)
<b>240 Z</b>													
2.4	1970.01	1973.12	113	154	-		6		X	X	JM5334	1	GT40RT
<b>320</b>													
1.2	1961.01	1965.12	-	-	-		4		X	X	JM5355	1	
<b>350 Z</b>													
3.5	2006.09	2009.12	228	306	VQ35HR		6	-	-	-	JM5484	6	
<b>410</b>													
1.2	1963.01	1963.12	45	61	-		4		X	X	JM5355	1	
<b>411</b>													
1.3	1963.01	1963.12	-	-	-		4		X	X	JM5355	1	
1.3	1966.01	1967.12	50	67	J13		4		X	X	JM5355	1	
1.6	1966.09	1967.12	72	98	R16		4		X	X	JM5355	1	
<b>720</b>													
2.4	1986.01	1986.12	77	105	Z24i		4		X	X	JM5603	2	VIN (N)
2.4 4WD	1986.01	1986.12	77	105	Z24i		4		X	X	JM5603	2	VIN (N)



<b>NISSAN USA</b>												
<b>ALTIMA</b>												
2.5 DOHC	2001.08	2006.09	121	165	QR25DE	4		X	X	JM5049	4	
2.5	2007.07	2010.12	128	174	QR25DE	4		X	X	JM5372	4	
3.5 24V	2002.10	2006.10	179	243	VQ35DE	6	-	-	-	JM5331	6	
3.5	2007.09	2010.12	201	270	VQ35DE	6		X	X	JM5484	6	
3.5	2010.09	-->	201	270	-	6		X	X	JM5484	6	
<b>APRIO</b>												
1.6	2007.09	2008.12	77	105	-	4	-	-	-	JM5008	4	JM1200 typ BERU OE 22448-00Q0A
1.6	2007.09	2008.12	77	105	-	4	-	-	-	JM5359	4	typ BREMI OE 22448-00Q0A
1.6	2007.09	2008.12	77	105	-	4	-	-	-	JM5445	4	typ DENSO OE 22448-00Q0A
<b>ARMADA</b>												
5.6	2004.09	2006.12	228	310	VK56DE	8	-	-	-	JM5485	8	
5.6 4WD	2004.09	2006.12	228	310	VK56DE	8	-	-	-	JM5485	8	
5.6 4WD	2006.09	2010.12	237	317	VK56DE	8	-	-	-	JM5485	8	
5.6	2010.09	-->	237	317	-	8		X	X	JM5485	8	
5.6 4x4	2012.01	-->	233	317	VK56DE	8		X	X	JM5485	8	
<b>CUBE</b>												
1.8	2009.01	2010.12	-	-	MR18DE	4	-	-	-	JM5372	4	
<b>D21</b>												
2.4	1985.09	1989.12	79	107	Z24	4		X	X	JM5603	2	VIN (N)
2.4 4WD	1985.09	1989.12	79	107	Z24	4		X	X	JM5603	2	VIN (N)
3.0	1985.09	1989.12	108	147	VG30	6		X	X	JM5603	1	VIN (H)
3.0 4WD	1985.09	1989.12	108	147	VG30	6		X	X	JM5603	1	VIN (H)
3.0	1990.01	1994.12	108	147	VG30	6		X	X	JM5135	1	VIN (H)
3.0 4WD	1990.01	1994.12	108	147	VG30	6		X	X	JM5135	1	VIN (H)
<b>FRONTIER</b>												
2.4	2000.09	2004.12	107	143	KA24DE	4	-/4	JP120	JPE120	JM5318	1	OE CM1T-227
2.4 4WD	2000.09	2004.12	107	143	KA24DE	4	-/4	JP120	JPE120	JM5318	1	OE CM1T-227
2.5	2004.09	2005.12	115	156	-	4	-	-	-	JM5483	4	
2.5 4WD	2004.09	2005.12	115	156	-	4	-	-	-	JM5483	4	
3.3 12V	1999.01	2004.12	127	173	VG33E	6		X	X	JM5319	1	
3.3 12V AWD	1999.01	2004.12	127	173	VG33E	6		X	X	JM5319	1	
4.0 24V	2004.10	2006.12	198	269	VQ40DE	6	-	-	-	JM5331	6	
4.0 24V AWD	2004.10	2006.12	198	269	VQ40DE	6	-	-	-	JM5331	6	
<b>MAXIMA</b>												
2.0 i 16V	2006.04	2008.01	-	-	QR20DE	4		X	X	JM5049	4	
3.0	1994.09	1999.12	142	193	VG30DE	6	-	-	-	JM5050	3	LH; sys. Hanshin VIN (C)
3.0	1994.09	1999.12	142	193	VG30DE	6	-	-	-	JM5450	3	LH; sys. Mitsubishi VIN (C)
3.0	1994.09	1999.12	142	193	VG30DE	6	-	-	-	JM5051	3	JM1186; RH sys. Hanshin; VIN (C)
3.0	1994.09	1999.12	142	193	VG30DE	6	-	-	-	JM5451	3	RH; sys. Mitsubishi VIN (C)
3.0 V6 DOHC	1995.01	1998.12	-	-	VQ30DE	6	-	-	-	JM5050	3	LH; sys. Hanshin
3.0 V6 DOHC	1995.01	1998.12	-	-	VQ30DE	6	-	-	-	JM5450	3	LH; sys. Mitsubishi
3.0 V6 DOHC	1995.01	1998.12	-	-	VQ30DE	6	-	-	-	JM5051	3	JM1186; RH sys. Hansin
3.0 V6 DOHC	1995.01	1998.12	-	-	VQ30DE	6	-	-	-	JM5451	3	RH; sys. Mitsubishi
3.0 V6 DOHC	1999.01	1999.12	-	-	VQ30DE	6	-	-	-	JM5050	3	LH; sys. Hanshin
3.0 V6 DOHC	1999.01	1999.12	-	-	VQ30DE	6	-	-	-	JM5450	3	LH; sys. Mitsubishi
3.0 V6 DOHC	1999.01	1999.12	-	-	VQ30DE	6	-	-	-	JM5051	3	JM1186; RH sys. Hansin
3.0 V6 DOHC	1999.01	1999.12	-	-	VQ30DE	6	-	-	-	JM5451	3	RH; sys. Mitsubishi
3.0	1999.09	2001.12	142	190	VG30DE	6	-	-	-	JM5133	3	JM1187; LH
3.0	1999.09	2001.12	142	190	VG30DE	6	-	-	-	JM5132	3	JM1186; RH
3.5 24V	2001.06	2007.12	190	258	VQ35DE	6	-	-	-	JM5331	6	
3.5	2007.09	2012.12	216	290	VQ35DE	6	-	-	-	JM5484	6	
<b>MICRA</b>												
1.0 i 16V	2000.07	2002.12	44	60	CG10DE	4		X	X	JM5047	4	
1.2	1983.09	1986.12	44	59	MA12	4		X	X	JM5465	1	VIN (H)
1.2	1990.01	1991.12	44	59	MA12	4		X	X	JM5135	1	VIN (H)
1.2	1998.01	1989.12	44	59	MA12	4		X	X	JM5603	1	VIN (H)
<b>MULTI</b>												
2.0	1985.09	1988.12	72	97	Z24i	4		X	X	JM5603	2	VIN (H)
2.0 4WD	1985.09	1988.12	72	97	Z24i	4		X	X	JM5603	2	VIN (H)



NISSAN USA												
<b>MURANO</b>												
3.5	2002.09	2007.12	183	249	VQ35DE	6	-	-	-	JM5331	6	
3.5 AWD	2002.09	2007.12	183	249	VQ35DE	6	-	-	-	JM5331	6	
3.5	2006.09	2008.12	194	260	VQ35DE	6	-	-	-	JM5331	6	
3.5 AWD	2006.09	2008.12	194	260	VQ35DE	6	-	-	-	JM5331	6	
3.5	2006.09	2008.12	198	265	VQ35DE	6	-	-	-	JM5331	6	
3.5 AWD	2006.09	2008.12	198	265	VQ35DE	6	-	-	-	JM5331	6	
3.5	2009.01	2012.12	194	260	VQ35DE	6	-	-	-	JM5484	6	VIN (A)
3.5 AWD	2009.01	2012.12	194	260	VQ35DE	6	-	-	-	JM5484	6	VIN (A)
3.5	2009.01	2010.12	198	265	VQ35DE	6	-	-	-	JM5484	6	VIN (A)
3.5 AWD	2009.01	2010.12	198	265	VQ35DE	6	-	-	-	JM5484	6	VIN (A)
3.5 AWD	2011.01	-->	191	260	VQ35	6	-	-	-	JM5484	6	
<b>NV</b>												
4.0	2011.09	-->	195	261	-	6	-	-	-	JM5331	6	
5.6	2011.09	-->	237	317	-	8	-	-	-	JM5485	8	
<b>PATHFINDER</b>												
2.4 E 4WD	1986.09	1987.12	79	107	Z24i	4		X	X	JM5603	2	VIN (N)
3.0 AWD	1986.09	1989.12	108	147	VG30I	6		X	X	JM5603	1	VIN (H)
3.0	1988.09	1989.12	108	147	VG30I	6		X	X	JM5603	1	VIN (H)
3.0	1990.01	1995.12	108	147	VG30E	6		X	X	JM5135	1	VIN (H)
3.0 AWD	1990.01	1995.12	108	147	VG30E	6		X	X	JM5135	1	VIN (H)
3.3 12V	1996.01	2000.12	125	170	VG33E	6		X	X	JM5319	1	
3.3 12V AWD	1996.01	2000.12	125	170	VG33E	6		X	X	JM5319	1	
3.5 24V	2001.07	2004.07	179	243	VQ35DE	6	-	-	-	JM5331	6	
3.5 24V AWD	2001.07	2004.07	179	243	VQ35DE	6	-	-	-	JM5331	6	
4.0 24V	2004.08	2007.04	201	273	VQ40DE	6	-	-	-	JM5331	6	
4.0 24V AWD	2004.08	2007.04	201	273	VQ40DE	6	-	-	-	JM5331	6	
4.0 4WD	2006.09	2010.12	199	271	VQ40DE	6		X	X	JM5331	6	
4.0	2010.09	-->	198	269	-	6		X	X	JM5485	6	
5.6	2004.01	2004.12	230	310	-	8	-	-	-	JM5424	8	
5.6 4WD	2004.01	2004.12	230	310	-	8	-	-	-	JM5424	8	
5.6	2007.09	2010.12	231	313	VK56DE	8		X	X	JM5485	8	
5.6 4WD	2007.09	2010.12	231	313	VK56DE	8		X	X	JM5485	8	
<b>PLATINA</b>												
1.6	2006.01	2009.12	81	110	-	4	-	-	-	JM5008	4	JM1200 typ BERU OE 22448-00Q0A
1.6	2006.01	2009.12	81	110	-	4	-	-	-	JM5359	4	typ BREMI OE 22448-00Q0A
1.6	2006.01	2009.12	81	110	-	4	-	-	-	JM5445	4	typ DENSO OE 22448-00Q0A
<b>PULSAR</b>												
1.6	1982.09	1986.12	51	69	E16I	4		X	X	JM5129	1	VIN (P)
1.6	1987.01	1988.12	-	-	E16I	4		X	X	JM5603	1	VIN (P)
<b>QUEST</b>												
3.3 12V	1999.01	2002.12	-	-	VG33E	6		X	X	JM5319	1	
3.5	2003.09	2009.12	175	238	VQ35DE	6	-	-	-	JM5331	6	
3.5	2010.09	-->	-	-	-	6		X	X	JM5484	6	
<b>ROGUE</b>												
2.5	2008.01	2010.12	-	-	QR25DE	4	-	-	-	JM5372	4	
2.5 4x4	2008.01	2010.12	-	-	QR25DE	4	-	-	-	JM5372	4	
<b>SENTRA</b>												
1.6	1998.01	1988.12	51	69	E16I	4		X	X	JM5603	1	VIN (P)
1.6 4WD	1998.01	1988.12	51	69	E16I	4		X	X	JM5603	1	VIN (P)
1.8	1999.09	2001.12	95	128	QG18DE	4	-	-	-	JM5017	4	OE 22448-4M500
1.8	2002.01	2006.12	95	128	QG18DE	4	-	-	-	JM5048	4	OE 22448-6N000
1.8 DOHC	2002.01	2006.12	95	128	QG18DE	4		X	X	JM5048	4	Model CA, GXE, XE
2.0	2010.01	2010.10	-	-	MR20DE	4		X	X	JM5372	4	
2.5 DOHC	2003.01	2003.12	-	-	QR25DE	4		X	X	JM5049	4	
2.5 DOHC	2006.09	-->	132	179	QR25DE	4		X	X	JM5049	4	
2.5	2007.01	2010.10	-	-	QR25DE	4		X	X	JM5372	4	
<b>STANZA</b>												
2.0	1986.09	1989.12	66	90	Eng. CA20E	4		X	X	JM5104	2	VIN (H) OE 22448-03E01
2.0	1986.09	1989.12	66	90	Eng. CA20E	4		X	X	JM5603	2	VIN (H) OE 22433-03G01
2.0	1986.09	1988.12	72	98	Eng. CA20E	4		X	X	JM5104	2	VIN (H) OE 22448-03E01
2.0	1986.09	1988.12	72	98	Eng. CA20E	4		X	X	JM5603	2	VIN (H) OE 22433-03G01



## NISSAN USA

STANZA												
2.0 4WD	1986.09	1988.12	72	98	Eng. CA20E	4		X	X	JM5104	2	VIN (H) OE 22448-03E01
2.0 4WD	1986.09	1988.12	72	98	Eng. CA20E	4		X	X	JM5603	2	VIN (H) OE 22433-03G01
TITAN												
5.6	2003.09	2006.12	228	310	-	8	-	-	-	JM5424	8	
5.6 4WD	2003.09	2006.12	228	310	-	8	-	-	-	JM5424	8	
5.6	2006.09	2012.12	237	317	VK56DE	8		X	X	JM5485	8	
5.6 4WD	2006.09	2012.12	237	317	VK56DE	8		X	X	JM5485	8	
VAN												
2.4	1986.09	1988.12	79	107	Z24i	4		X	X	JM5603	2	VIN (S)
VERSA												
1.6	2009.01	2011.10	-	-	HR16DE	4		X	X	JM5372	4	
1.8 16V	2007.01	2011.12	91	124	MR18DE	4	-	-	-	JM5372	4	
XTERRA												
2.4	1999.09	2004.12	107	146	KA24DE	4	-/4	JP120	JPE120	JM5318	1	
2.4 AWD	1999.09	2004.12	107	146	KA24DE	4	-/4	JP120	JPE120	JM5318	1	
3.3 12V	2000.01	2004.12	127	173	VG33E	6		X	X	JM5319	1	
3.3 12V AWD	2000.01	2004.12	127	173	VG33E	6		X	X	JM5319	1	
4.0 24V	2005.01	2007.08	198	269	VQ40DE	6	-	-	-	JM5331	6	
4.0 24V AWD	2005.01	2007.08	198	269	VQ40DE	6	-	-	-	JM5331	6	
X-TRAIL												
2.5 16V	2005.01	2008.12	-	-	-	4	-	-	-	JM5049	4	

## OLDSMOBILE

98 REGENCY												
3.8 V6	-->	1995.12	-	-	-	6	-/6	AM8	AMU8	X	-	
ACHIEVA												
3.3 V6	1991.09	1993.12	119	162	-	6	-/6	AM20	AMU20	X	-	
BRAVADA												
4.3 V6	-->	1991.12	-	-	-	6	1/6	AM30	AMU30	X	-	
4.3 V6	1992.01	1994.12	-	-	-	6	-/6	AM33	AMU33	X	-	
CALAIS												
2.5	1988.01	1991.01	-	-	-	4	-/4	AM21	AMU21	JM5290	2	
3.3 V6	1989.01	1991.01	-	-	-	6	-/6	AM20	AMU20	JM5290	3	
CIERA												
2.2	1993.01	1995.12	-	-	-	4	-/4	AM18	AMU18	X	-	
2.5	1982.01	1992.12	-	-	-	4	-/4	AM19	AMU19	X	-	
3.1 V6	1982.01	1990.12	-	-	-	6	1/6	AM9	AMU9	X	-	
3.1 SL	1992.10	1996.12	119	162	-	6	-/6	AM17	AMU17	X	-	
3.3 V6	1982.01	1996.12	119	162	-	6	-/6	AM20	AMU20	X	-	
CUSTOM CRUISER												
5.0 V8	1979.09	1990.12	104	141	-	8	-/8	AM29	AMU29	X	-	
5.0 V8	1991.01	-->	-	-	-	8	1/8	AM34	AMU34	X	-	
5.7 V8	1991.01	-->	-	-	-	8	1/8	AM34	AMU34	X	-	
CUTLASS												
3.1 V6	1994.09	1996.12	116	158	-	6	-/6	AM17	AMU17	JM5290	3	
CUTLASS SUPREME												
2.8 V6	1988.09	1989.12	97	132	LB6	6	-/6	AM16	AMU16	JM5290	3	VIN (W); OE 10467067
3.1 V6	1988.09	1993.12	101	137	LH0	6	-/6	AM16	AMU16	JM5290	3	VIN (T); OE 10467067
3.1	1989.01	1993.09	104	141	LH0	6	-/6	AM16	AMU16	JM5290	3	VIN (T); OE 10467067
3.1	1993.10	1997.09	119	162	-	6	-/6	AM17	AMU17	JM5290	3	
3.4 V6	1990.09	1996.12	149	203	6V <X MPI>	6		X	X	JM5290	3	
DELTA '88												
3.8	1985.09	1991.12	112	152	-	6	-/6	AM20	AMU20	JM5624	1	VIN (3); OE 12353801
3.8	1985.09	1988.12	112	152	-	6		X	X	JM5290	3	VIN (3); OE 10467067
SILHOUETTE												
3.1	1989.10	1995.10	90	122	LG6	6	-/6	AM20	AMU20	X	-	
3.8	1989.10	1995.10	127	173	L27	6	-/6	AM8	AMU8	JM5290	3	
TORONADO												
3.8	1985.09	1987.12	104	141	-	6	-/6	AM8	AMU8	JM5624	1	VIN (B); OE 12353801
3.8	1985.09	1987.12	104	141	-	6	-/6	AM8	AMU8	JM5290	3	VIN (B); OE 10467067
3.8	1988.01	1990.12	104	141	-	6	-/6	AM8	AMU8	JM5624	1	VIN (C); OE 12353801
3.8	1991.01	1992.12	104	141	-	6	-/6	AM8	AMU8	JM5290	3	VIN (L); OE 10467067



OLDSMOBILE USA													
<b>88</b>													
3.8	1991.09	1992.12	127	173	-	6	-/6	AM20	AMU20	JM5624	1	VIN (L); OE 12353801	
3.8	1991.09	1994.12	127	173	-	6	-/6	AM20	AMU20	JM5290	3	VIN (L); OE 10467067	
3.8	1995.09	1999.12	127	173	-	6		X	X	JM5290	3	VIN (1), VIN (K) OE 10467067	
<b>98</b>													
3.0 V6	1985.01	1985.12	-	-	181cid.	6		X	X	JM5366	1	VIN (E)	
3.8 V6	1985.01	1985.12	-	-	-	6		X	X	JM5366	1	VIN (3)	
3.8 V6	1986.01	1986.12	-	-	-	6		X	X	JM5624	1	VIN (B); OE 12353801	
3.8 V6	1986.01	1986.12	-	-	-	6		X	X	JM5290	3	VIN (B); OE 10467067	
3.8 V6	1987.01	1987.12	-	-	-	6		X	X	JM5624	1	VIN (3); OE 12353801	
3.8 V6	1987.01	1987.12	-	-	-	6		X	X	JM5290	3	VIN (3); OE 10467067	
3.8 V6	1988.01	1990.12	-	-	-	6		X	X	JM5624	1	VIN (C); OE 12353801	
3.8 V6	1991.01	1992.12	-	-	-	6		X	X	JM5624	1	VIN (L); OE 12353801	
3.8 V6	1992.01	1992.12	-	-	-	6		X	X	JM5290	3	VIN (L); OE 10467067	
3.8 V6	1992.01	1992.12	-	-	-	6		X	X	JM5290	3	VIN (1); OE 10467067	
3.8 V6	-->	1995.12	-	-	-	6	-/6	AM8	AMU8	X	-		
4.1 V6	1981.01	1983.12	-	-	252cid.	6		X	X	JM5366	1	VIN (4)	
5.0 V8	1980.01	1984.12	-	-	307cid.	8		X	X	JM5366	1	VIN (Y)	
5.7 V8	1974.01	1974.12	-	-	-	8		X	X	JM5366	1		
5.7 V8	1977.01	1979.12	-	-	350cid.	8		X	X	JM5366	1	VIN (R); California	
5.7 V8	1977.01	1979.12	-	-	350cid.	8		X	X	JM5367	1	VIN (R); Exp. California	
5.7 V8	1980.01	1980.12	-	-	350cid.	8		X	X	JM5366	1	VIN (Y)	
6.6 V8	1975.01	1975.12	-	-	400cid.	8		X	X	JM5366	1	VIN (S)	
6.6 V8	1977.01	1979.12	-	-	403cid.	8		X	X	JM5366	1	VIN (K)	
7.5 V8	1974.01	1976.12	-	-	455cid.	8		X	X	JM5366	1	VIN (T), VIN (U)	
<b>ACHIEVA</b>													
2.3 SOHC	1991.09	1994.12	86	117	-	4		X	X	JM5384	2	JM1189; VIN (3); Coil Cover OE 10475706	
2.3 DOHC	1991.09	1995.12	86	117	-	4		X	X	JM5384	2	JM1189; VIN (D); Coil Cover OE 10475706	
2.3	1991.09	1994.12	86	117	-	4		X	X	JM5384	2	JM1189; VIN (A); Coil Cover OE 10475706	
2.4 DOHC	1995.09	1998.12	112	152	-	4		X	X	JM5384	2	JM1189; VIN (T); Coil Cover OE 10475706	
3.3 V6	1991.09	1993.12	119	162	-	6	-/6	AM20	AMU20	X	-		
<b>ALERO</b>													
2.4 DOHC	1998.09	2001.12	112	152	-	4		X	X	JM5384	2	JM1189; VIN (T); Coil Cover OE 10475706	
<b>AURORA</b>													
4.0	1994.09	1999.12	187	254	-	8	-/8	AM86	AMU86	JM5290	4	VIN (C)	
4.0	2001.01	2003.12	187	254	-	8		X	X	JM5504	1	VIN (C); black	
4.0	2001.01	2003.12	187	254	-	8		X	X	JM5505	1	VIN (C); grey	
<b>BRAVADA</b>													
4.3 12V AWD	1990.09	1992.12	119	162	-	6	1/6	AM30	AMU30	JM5369	1	VIN (W), (Z) VIN	
4.3 12V AWD	1991.01	1994.12	119	162	-	6		X	X	JM5369	1	VIN (W), (Z) VIN	
4.3 V6	1992.01	1994.12	-	-	-	6	-/6	AM33	AMU33	X	-		
4.3 4WD	1995.09	2001.12	119	162	-	6		X	X	JM5385	1	VIN (W)	
<b>CALAIS</b>													
2.3 DOHC	1986.09	1987.12	112	152	-	4		X	-	JM5384	2	JM1189; VIN (D); Coil Cover OE 10475706	
2.5 8V	1985.01	1986.12	69	94	-	4		X	X	JM5369	1	VIN (U)	
2.5	-->	1991.12	-	-	-	4	-/4	AM21	AMU21	X	-		
3.0	1984.09	1987.12	93	126	-	6		X	X	JM5624	1	VIN (L); OE 12353801	
3.3 V6	-->	1991.12	-	-	-	6	-/6	AM20	AMU20	X	-		
<b>CIERA</b>													
2.2	1993.01	1995.12	-	-	-	4	-/4	AM18	AMU18	X	-		
2.5	-->	1992.12	-	-	-	4	-/4	AM19	AMU19	X	-		
3.1 V6	-->	1990.12	-	-	-	6	1/6	AM9	AMU9	X	-		
3.1 SL	1992.10	1996.12	119	162	-	6	-/6	AM17	AMU17	X	-		
3.3 V6	-->	-->	-	-	-	6	-/6	AM20	AMU20	X	-		
<b>CUSTOM CRUISER</b>													
5.0 V8	1979.09	1990.12	104	141	-	8	-/8	AM29	AMU29	X	-		
5.0 V8	1991.01	-->	-	-	-	8	1/8	AM34	AMU34	X	-		
5.7 V8	1991.01	-->	-	-	-	8	1/8	AM34	AMU34	X	-		
<b>CUTLASS</b>													
3.1 V6	-->	1994.12	-	-	-	6	1/6	AM9	AMU9	X	-		
3.1 V6	1994.09	1996.12	116	158	-	6	-/6	AM17	AMU17	X	-		
4.1 12V	1975.01	1976.12	78	106	-	6		X	X	JM5368	1	VIN (D)	



## OLDSMOBILE USA

### CUTLASS CALAIS

2.3 DOHC	1987.09	1991.12	112	152	-	4		X	-	JM5384	2	JM1189; VIN (D); Coil Cover OE 10475706
2.3	1989.01	1991.12	112	152	-	4		X	-	JM5384	2	JM1189; VIN (A); Coil Cover OE 10475706
3.0	1987.09	1988.12	82	112	-	6		X	X	JM5624	1	VIN (L); OE 12353801

### CUTLASS CIERA

2.8	1987.09	1989.12	84	114	-	6	-/6	AM16	AMU16	JM5290	3	VIN (W); OE 10467067
3.8	1983.09	1984.12	112	152	-	6		X	X	JM5366	1	VIN (3); OE 1876209
3.8	1985.01	1986.12	112	152	-	6		X	X	JM5366	1	VIN (E); OE 1876209
3.8	1986.01	1988.12	112	152	-	6		X	X	JM5624	1	VIN (3) OE 12353801
3.8	1986.01	1988.12	112	152	-	6		X	X	JM5290	3	VIN (3); OE 10467067

### CUTLASS CRUISER

2.8	1987.09	1989.12	84	114	-	6	-/6	AM16	AMU16	JM5290	3	VIN (W); OE 10467067
3.8	1986.09	1988.12	112	152	-	6		X	X	JM5290	3	VIN (3); OE 10467067
3.8	1986.09	1988.12	112	152	-	6		X	X	JM5624	1	VIN (3); OE 12353801

### CUTLASS SUPREME

2.3 DOHC	1989.09	1991.12	119	162	-	4	-	-	-	JM5384	2	JM1189; VIN (D); Coil Cover OE 10475706
2.3	1989.09	1990.12	119	162	-	4	-	-	-	JM5384	2	JM1189; VIN (A); Coil Cover OE 10475706
2.8	1987.09	1989.12	93	126	-	6	-/6	AM16	AMU16	JM5290	3	VIN (W); OE 10467067
2.8 V6	1988.09	1989.12	97	132	LB6	6	-/6	AM16	AMU16	JM5290	3	VIN (W); OE 10467067
3.1 V6	1988.09	1993.12	101	137	LH0	6	-/6	AM16	AMU16	JM5290	3	VIN (T); OE 10467067
3.1	1989.01	1993.09	104	141	LH0	6	-/6	AM16	AMU16	JM5290	3	VIN (T); OE 10467067
3.1	1989.09	1993.12	104	141	-	6	-/6	AM16	AMU16	JM5290	3	VIN (T); OE 10467067
3.1	1993.01	1993.12	104	141	-	6	-/6	AM16	AMU16	JM5290	3	VIN (M); OE 10467067
3.1	1993.10	1997.09	119	162	-	6	-/6	AM17	AMU17	X	-	
3.4 V6	1990.09	-->	149	203	6V <X MPI>	6		X	X	JM5290	3	

### DELTA

3.0	1985.09	1986.12	93	126	-	6		X	X	JM5624	1	VIN (L); OE 12353801
3.8	1985.09	1988.12	112	152	-	6	-/6	AM20	AMU20	JM5624	1	VIN (3); OE 12353801
3.8	1985.09	1988.12	112	152	-	6		X	X	JM5290	3	VIN (3); OE 10467067
3.8	1988.09	1991.12	112	152	-	6	-/6	AM20	AMU20	JM5624	1	VIN (C); OE 12353801

### REGENCY

3.8	1996.09	1997.12	153	208	-	6		X	X	JM5624	1	VIN (K); OE 12353801
3.8	1996.09	1998.12	153	208	-	6		X	X	JM5290	3	VIN (K); OE 10467067

### SILHOUETTE

3.1	1989.10	1995.10	90	122	LG6	6	-/6	AM20	AMU20	X	-	
3.8	1989.10	1995.10	127	173	L27	6	-/6	AM8	AMU8	X	-	

### TORONADO

3.8	1985.09	1986.12	104	141	-	6	-/6	AM8	AMU8	JM5624	1	VIN (B); OE 12353801
3.8	1985.09	1986.12	104	141	-	6	-/6	AM8	AMU8	JM5290	3	VIN (B); OE 10467067
3.8	1987.09	1997.12	104	141	-	6	-/6	AM8	AMU8	JM5624	1	VIN (3); OE 12353801
3.8	1987.09	1997.12	104	141	-	6	-/6	AM8	AMU8	JM5290	3	VIN (3); OE 10467067
3.8	1988.09	1990.12	104	141	-	6	-/6	AM8	AMU8	JM5624	1	VIN (C); OE 12353801
3.8	1991.01	1992.12	104	141	-	6	-/6	AM8	AMU8	JM5290	3	VIN (L); OE 10467067

## OPEL USA

### RALLYE

1.5	1968.01	1968.12	-	-	-	4		X	X	JM5355	1	
1.9	1968.01	1970.12	-	-	-	4		X	X	JM5355	1	

## OTOSAN

### ANADOL

1.3	1970.10	1976.08	42	57	KL13	4	1/4	FS1	FU1	X	1	
1.3	1976.09	1982.08	43	58	KL13H	4	1/4	FS1	FU1	X	1	

## PANOZ USA

### AIV ROADSTER

4.6	1998.09	2000.12	239	325	-	8	-	-	-	JM5088	8	JM1193
-----	---------	---------	-----	-----	---	---	---	---	---	--------	---	--------

### ESPERANTE

4.6	2000.09	2005.12	239	325	-	8	-	-	-	JM5088	8	JM1193
4.6	2005.09	2006.12	291	390	-	8	-	-	-	JM5088	8	JM1193; 281cid





											<b>PEUGEOT USA</b>		
<b>203</b>													
1.3	1955.01	1957.12	-	-	-	4		X		X	JM5335	1	for BOSCH GT40T R1=3.0[Ω], R2=8.5[kΩ]
1.5	1955.01	1959.12	-	-	-	4		X		X	JM5335	1	for BOSCH GT40T R1=3.0[Ω], R2=8.5[kΩ]
<b>304</b>													
1.3	1971.01	1972.12	-	-	-	4		X		X	JM5335	1	for BOSCH GT40T R1=3.0[Ω], R2=8.5[kΩ]
<b>403</b>													
1.5	1964.01	1967.12	-	-	-	4		X		X	JM5335	1	for BOSCH GT40T R1=3.0[Ω], R2=8.5[kΩ]
<b>404</b>													
1.6	1967.01	1969.12	-	-	-	4		X		X	JM5335	1	for BOSCH GT40T R1=3.0[Ω], R2=8.5[kΩ]
1.8	1970.01	1970.12	-	-	-	4		X		X	JM5335	1	for BOSCH GT40T R1=3.0[Ω], R2=8.5[kΩ]
<b>504</b>													
1.8	1970.01	1970.12	-	-	-	4		X		X	JM5335	1	for BOSCH GT40T R1=3.0[Ω], R2=8.5[kΩ]
2.0	1971.01	1974.12	-	-	-	4		X		X	JM5335	1	for BOSCH GT40T R1=3.0[Ω], R2=8.5[kΩ]
2.0	1975.01	1979.12	-	-	-	4		X		X	JM5335	1	for BOSCH GT40T R1=3.0[Ω], R2=8.5[kΩ]
											<b>PLYMOUTH</b>		
<b>BREEZE</b>													
2.0 16V	1995.12	2001.04	103	140	-	4	-/4	AM15		AMU15	JM5070	1	
2.0 16V	1996.01	1996.12	103	140	-	4	-/4	AM15		AMU15	JM5071	1	
2.4 16 V	1995.12	2001.04	103	140	-	4	-/4	AM15		AMU15	JM5070	1	
2.4 16 V	1996.01	1996.12	103	140	-	4	-/4	AM15		AMU15	JM5071	1	
<b>NEON</b>													
2.0 16V	1994.05	1999.08	98	133	-	4		X		X	JM5287	1	
2.0 16V	1994.06	1999.08	107	145	-	4		X		X	JM5287	1	
2.0 16V	1996.04	1999.08	112	152	-	4		X		X	JM5287	1	
2.0 16V	1999.08	-->	98	133	-	4		X		X	JM5287	1	
<b>VOYAGER</b>													
2.4 i	1995.01	2001.03	111	151	-	4		X		X	JM5287	1	
3.3 LE	1989.10	1990.09	112	152	-	6	-/6	AM10		AMU10	JM5072	1	
3.3 i	1995.01	2001.03	116	158	-	6	-/6	AM68		AMU68	JM5072	1	
3.3 i	1999.01	2000.12	116	158	-	6	-/6	AM68		AMU68	JM5388	1	VIN (G); OE 4609140AB
3.3 i	1999.01	2000.12	116	158	-	6	-/6	AM68		AMU68	JM5388	1	VIN (R); OE 4609140AB
3.3 Flex-Fuel	1999.01	2001.03	116	158	EGM	6	-/6	AM68		AMU68	JM5388	1	VIN (G); OE 4609140AB
3.3 Flex-Fuel	1999.01	2001.03	116	158	EGM	6	-/6	AM68		AMU68	JM5388	1	VIN (R); OE 4609140AB
3.8 i	1995.01	2001.03	122	166	-	6	-/6	AM68		AMU68	JM5072	1	
3.8 i AWD	1995.01	2001.03	122	166	-	6	-/6	AM68		AMU68	JM5072	1	
3.8 i	1995.01	2001.03	131	178	-	6	-/6	AM68		AMU68	JM5072	1	
3.8 i AWD	1995.01	2001.03	131	178	-	6	-/6	AM68		AMU68	JM5072	1	
3.8 i	1999.01	2000.12	122	166	-	6	-/6	AM68		AMU68	JM5388	1	VIN (G); OE 4609140AB
3.8 i	1999.01	2000.12	122	166	-	6	-/6	AM68		AMU68	JM5388	1	VIN (R); OE 4609140AB
3.8 i AWD	1999.01	2000.12	122	166	-	6	-/6	AM68		AMU68	JM5388	1	VIN (G); OE 4609140AB
3.8 i AWD	1999.01	2000.12	122	166	-	6	-/6	AM68		AMU68	JM5388	1	VIN (R); OE 4609140AB
3.8 i	1999.01	2000.12	131	178	-	6	-/6	AM68		AMU68	JM5388	1	VIN (G); OE 4609140AB
3.8 i	1999.01	2000.12	131	178	-	6	-/6	AM68		AMU68	JM5388	1	VIN (R); OE 4609140AB
3.8 i AWD	1999.01	2000.12	131	178	-	6	-/6	AM68		AMU68	JM5388	1	VIN (G); OE 4609140AB
3.8 i AWD	1999.01	2000.12	131	178	-	6	-/6	AM68		AMU68	JM5388	1	VIN (R); OE 4609140AB
											<b>PLYMOUTH USA</b>		
<b>BELVEDERE</b>													
3.8	1954.01	1959.12	-	-	-	6		X		X	JM5335	1	for BOSCH GT40T R1=3.0[Ω], R2=8.5[kΩ]
<b>BREEZE</b>													
2.0 SOHC 122 cid.	1996.12	-->	-	-	ECB	4		X		X	JM5071	1	VIN (C)
2.4 DOHC 148 cid.	1997.01	2000.12	-	-	EDZ	4		X		X	JM5070	1	VIN (X)



<b>PLYMOUTH USA</b>											
<b>CARAVELLE</b>											
3.7	1977.09	1979.12	75	102	-	6	1/6	AM101	AMU101	X	-
3.7	1980.09	1982.12	67	90	-	6	1/6	AM101	AMU101	X	-
1.5 12V	1993.01	1994.12	69	94	-	4		X	X	JM5198	1
1.5 L4 MFI SOHC	1993.01	1994.12	-	-	90cid.	4		X	X	JM5198	1
1.5	1994.09	1995.12	69	92	-	4		X	X	JM5198	1
1.8	1991.09	1994.12	84	114	-	4		X	X	JM5197	1
1.8 AWD	1991.09	1994.12	84	114	-	4		X	X	JM5197	1
1.8 L4 MFI SOHC	1993.01	1994.12	-	-	112cid.	4		X	X	JM5197	1
<b>CRICKET</b>											
1.5	1971.01	1973.12	41	56	-	4		X	X	JM5335	1 for BOSCH GT40T R1=3.0[Ω], R2=8.5[kΩ]
<b>DUSTER</b>											
3.7	1974.09	1976.12	71	97	-	6	1/6	AM101	AMU101	X	-
<b>FURY</b>											
3.7	1974.09	1978.12	71	97	-	6	1/6	AM101	AMU101	X	-
3.8	1956.01	1959.12	-	-	-	6		X	X	JM5335	1 for BOSCH GT40T R1=3.0[Ω], R2=8.5[kΩ]
6.6 V8	1973.01	1978.12	-	-	400cid.	8		X	X	JM5613	1
7.2 V8	1973.01	1978.12	-	-	440cid.	8		X	X	JM5613	1
<b>GRAND FURY</b>											
6.6 V8	1973.01	1977.12	-	-	400cid.	8		X	X	JM5613	1
7.2 V8	1973.01	1977.12	-	-	440cid.	8		X	X	JM5613	1
<b>GRAND VOYAGER</b>											
2.4 DOHC	1996.12	1997.12	-	-	148cid	4		X	X	JM5071	1 VIN (B)
2.4 DOHC	1997.01	-->	-	-	148cid	4		X	X	JM5070	1 VIN (B)
3.3 LE V6 OHV	1990.01	1995.12	-	-	201cid.	6		X	X	JM5072	1 VIN (R)
3.3 SE V6 OHV	1990.01	1997.12	-	-	201cid.	6		X	X	JM5072	1 VIN (R)
3.3 LE V6 CNG OHV	1996.12	-->	-	-	201cid.	6		X	X	JM5072	1 VIN (J)
3.3 SE V6 CNG OHV	1996.12	-->	-	-	201cid.	6		X	X	JM5072	1 VIN (J)
3.3 V6 OHV	1997.01	-->	-	-	EGA	6		X	X	JM5072	1 VIN (R)
3.3 V6 FLEX OHV	1998.01	-->	-	-	EGM	6		X	X	JM5072	1 VIN (G)
3.3 Flexfuel	1999.01	2000.12	118	160	-	6	-/6	AM68	AMU68	JM5388	1 VIN (G); OE 4609140AB
3.3 Flexfuel	1999.01	2000.12	118	160	-	6	-/6	AM68	AMU68	JM5388	1 VIN (R); OE 4609140AB
3.8 LE V6 OHV	1995.01	1997.12	-	-	230cid.	6		X	X	JM5072	1 VIN (L)
3.8 SE V6 OHV	1997.01	-->	-	-	230cid.	6		X	X	JM5072	1 VIN (L)
3.8 V6 OHV	1998.01	-->	-	-	230cid.	6		X	X	JM5072	1 VIN (L)
3.8	1998.09	1999.12	130	177	-	6	-/6	AM68	AMU68	JM5388	1 VIN (L)
<b>LASER</b>											
1.8 L4 MFI SOHC	1991.01	1994.12	-	-	107cid.	4		X	X	JM5198	1
2.0 16V	1990.01	1994.12	101	137	-	4	-/4	JP107	JPE107	JM5326	2
<b>NEON</b>											
2.0 DOHC	1995.01	1997.12	-	-	ECC	4		X	X	JM5070	1 VIN (Y)
2.0 SOHC	1995.01	1996.12	-	-	122cid.	4		X	X	JM5071	1 VIN (C)
<b>PB200</b>											
6.6 V8	1976.01	1978.12	-	-	400cid.	8		X	X	JM5613	1
7.2 V8	1976.01	1978.12	-	-	440cid.	8		X	X	JM5613	1
<b>PB300</b>											
6.6 V8	1976.01	1978.12	-	-	400cid.	8		X	X	JM5613	1
7.2 V8	1976.01	1978.12	-	-	440cid.	8		X	X	JM5613	1
<b>PLAZA</b>											
3.8	1954.01	1958.12	-	-	-	6		X	X	JM5335	1 for BOSCH GT40T R1=3.0[Ω], R2=8.5[kΩ]
<b>ROADRUNNER</b>											
6.6 V8	1973.01	1974.12	-	-	400cid.	8		X	X	JM5613	1
7.2 V8	1973.01	1974.12	-	-	440cid.	8		X	X	JM5613	1
<b>SATELLITE</b>											
6.6 V8	1973.01	1974.12	-	-	400cid.	8		X	X	JM5613	1
7.2 V8	1974.01	1974.12	-	-	440cid.	8		X	X	JM5613	1
<b>SAVOY</b>											
3.8	1954.01	1959.12	-	-	-	6		X	X	JM5335	1 for BOSCH GT40T R1=3.0[Ω], R2=8.5[kΩ]
<b>SCAMP</b>											
3.7	1974.09	1976.12	71	97	-	6	1/6	AM101	AMU101	X	-
<b>SUBURBAN</b>											
3.8	1954.01	1959.12	93	126	-	6		X	X	JM5335	1 for BOSCH GT40T R1=3.0[Ω], R2=8.5[kΩ]



PLYMOUTH USA												
<b>TRAILDUSTER</b>												
6.6 V8	1976.01	1978.12	-	-	400cid.	8		X	X	JM5613	1	
7.2 V8	1974.01	1978.12	-	-	440cid.	8		X	X	JM5613	1	
<b>VALIANT</b>												
3.7	1974.09	1975.12	71	97	-	6	1/6	AM101	AMU101	X	-	
<b>VOLARE</b>												
3.7	1975.09	1980.12	67	91	-	6	1/6	AM101	AMU101	X	-	
<b>VOYAGER</b>												
2.4 DOHC	1996.12	1997.12	-	-	148cid	4		X	X	JM5071	1	VIN (B)
2.4 DOHC	1997.01	2000.12	-	-	148cid	4		X	X	JM5070	1	VIN (B)
3.3 LE V6 OHV	1991.01	1995.12	-	-	201cid.	6		X	X	JM5072	1	VIN (R)
3.3 SE V6 OHV	1991.01	1997.12	-	-	201cid.	6		X	X	JM5072	1	VIN (R)
3.3 LX V6 OHV	1994.01	-->	-	-	201cid.	6		X	X	JM5072	1	VIN (R)
3.3 SE V6 CNG OHV	1994.01	1996.12	-	-	201cid.	6		X	X	JM5072	1	VIN (J)
3.3 V6 CNG OHV	1994.01	1996.12	-	-	201cid.	6		X	X	JM5072	1	VIN (J)
3.3 V6 OHV	1995.01	1997.12	-	-	201cid.	6		X	X	JM5072	1	VIN (R)
3.8 LE V6 OHV	1997.01	-->	-	-	230cid.	6		X	X	JM5072	1	VIN (L)
<b>PONTIAC</b>												
<b>ALL 8 CYL</b>												
All 8-cylindres	1963.01	1969.12	-	-	-	8		X	X	JM5334	1	GT40RT
<b>BONNEVILLE</b>												
3.8 V6	1986.09	1988.12	122	166	LG3	6	-/6	AM20	AMU20	JM5290	3	VIN (3)
3.8 V6	1988.01	1991.12	122	166	LG3	6	-/6	AM20	AMU20	JM5624	1	VIN (C)
3.8	1991.09	1995.09	127	173	L27	6		X	X	JM5290	3	VIN (1), VIN (L)
3.8	1991.09	1992.12	127	173	L27	6		X	X	JM5624	1	VIN (1), VIN (L) OE 12353801
3.8	1991.09	1992.12	176	239	L67	6		X	X	JM5624	1	VIN (1), VIN (L) OE 12353801
3.8	1991.09	1999.09	176	239	L67	6		X	X	JM5290	3	VIN (1), VIN (L) VIN (K)
3.8 V6	1991.09	-->	149	203	L36	6	-/6	AM8	AMU8	JM5624	1	VIN (1), VIN (L)
3.8 V6	1991.09	-->	149	203	L36	6	-/6	AM8	AMU8	JM5290	3	VIN (1), VIN (L)
3.8	1994.09	2005.09	153	208	L36	6		X	X	JM5290	3	VIN (1), VIN (K)
3.8	1999.09	2005.09	179	243	L67	6		X	X	JM5290	3	VIN (1), VIN (K)
<b>FIREBIRD</b>												
3.1 V6	1990.01	1992.12	-	-	-	6	1/6	AM14	AMU14	X	-	
3.4	1993.01	-->	119	162	-	6	-/6	AM20	AMU20	JM5290	3	
3.8	1994.10	1997.12	149	203	-	6	-/6	AM26	AMU26	X	-	
5.0	1990.01	1992.10	145	197	-	8	1/8	AM34	AMU34	X	-	
5.7	1990.01	1992.10	179	243	-	8	1/8	AM34	AMU34	X	-	
5.7	1992.10	1997.12	201	273	-	8	1/8	AM36	AMU36	X	-	
5.7	1993.10	1996.12	205	279	LT1	8	1/8	AM24	AMU24	X	-	
5.7	1996.01	1996.12	205	279	LT1	8		X	X	JM5385	1	VIN (P)
<b>G6</b>												
3.5 GT	2004.03	2006.08	149	203	LX9	6		X	X	JM5496	1	
3.5	2006.09	-->	167	227	-	6		X	X	JM5496	1	
<b>GRAND AM</b>												
2.5	-->	1991.12	-	-	-	4	-/4	AM21	AMU21	X	-	
3.1 V6	1994.01	1995.12	-	-	-	6	-/6	AM8	AMU8	X	-	
3.3 V6	-->	1993.12	-	-	-	6	-/6	AM20	AMU20	X	-	
<b>GRAND PRIX</b>												
2.8 V6	-	-	-	-	-	6	-/6	AM16	AMU16	X	-	
3.1 V6	-->	1993.12	-	-	-	6	1/6	AM9	AMU9	X	-	
3.1	1988.10	1993.12	104	141	-	6	-/6	AM16	AMU16	JM5290	3	VIN (T); OE 10467067
3.1	1992.01	1993.12	102	139	L82	6	-/6	AM16	AMU16	JM5290	3	VIN (T), VIN (V) OE 10467067
3.1	1992.01	1993.12	115	156	L82	6	-/6	AM16	AMU16	JM5290	3	VIN (T), VIN (V) OE 10467067
3.1 SE	1992.01	1993.12	119	162	L82	6	-/6	AM16	AMU16	JM5290	3	VIN (T), VIN (V) OE 10467067
3.1 V6	1993.01	-->	-	-	-	6	-/6	AM17	AMU17	X	-	
3.1	1996.07	1999.07	119	162	-	6	-/6	AM8	AMU8	X	-	
<b>MONTANA</b>												
3.4	1998.04	2005.08	138	188	-	6	-/6	AM58	AMU58	JM5290	3	VIN (E)
3.4 Allrad	1998.04	2005.08	138	188	-	6	-/6	AM58	AMU58	JM5290	3	VIN (E)
3.9	2004.04	-->	179	243	LZ9	6		X	X	JM5496	1	VIN (1)
3.9 4x4	2004.04	-->	179	243	LZ9	6		X	X	JM5496	1	VIN (1)



## PONTIAC

<b>SOLSTICE</b>												
2.4 VVTi	2005.03	2009.12	132	179	LE5	4	-	-	-	JM5609	4	OE 12638824
<b>SUNBIRD</b>												
3.1 V6	-->	1994.12	-	-	-	6	-/6	AM17	AMU17	X	-	
<b>SUNFIRE</b>												
2.2	1994.06	1998.10	90	122	-	4	-/4	AM18	AMU18	X	-	
2.4	1996.01	2002.10	112	152	-	4		X	-	JM5384	2	JM1189; VIN (T); Coil Cover OE 10475706
<b>TORRENT</b>												
3.4	2004.08	-->	138	188	LNJ	6	-/6	AM89	AMU89	JM5496	1	VIN (F)
3.4 4x4	2004.08	-->	138	188	LNJ	6	-/6	AM89	AMU89	JM5496	1	VIN (F)
<b>TRANS SPORT '89</b>												
3.1	1989.07	1997.03	90	122	-	6	1/6	AM9	AMU9	X	-	
3.1	1989.07	1997.03	104	141	-	6	1/6	AM9	AMU9	X	-	
3.8	1989.07	1997.03	112	152	-	6	-/6	AM8	AMU8	JM5290	3	
3.8	1989.07	1997.03	123	167	-	6	-/6	AM8	AMU8	JM5290	3	
3.8	1989.07	1997.03	127	172	-	6	-/6	AM8	AMU8	JM5290	3	
<b>TRANS SPORT '97</b>												
3.4	1997.03	1998.09	134	182	LA1	6		X	X	JM5290	3	
3.4	1998.09	-->	137	186	-	6		X	X	JM5290	3	

## PONTIAC USA

<b>6000</b>												
2.5	1982.01	1983.12	67	91	-	4		X	X	JM5368	1	VIN (5), VIN (R)
2.8 12V	1982.01	1982.12	-	-	-	6		X	X	JM5367	1	VIN (X)
2.8 12V	1983.01	1984.12	-	-	-	6		X	X	JM5368	1	VIN (X); USA
2.8 12V	1983.01	1984.12	-	-	-	6		X	X	JM5369	1	VIN (X); Canada
2.8 12V	1983.01	1984.12	-	-	-	6		X	X	JM5368	1	VIN (Z)
2.8 12V	1985.01	1986.12	-	-	-	6		X	X	JM5369	1	VIN (X), VIN (W)
2.8 12V	1985.01	1986.12	-	-	-	6		X	X	JM5369	1	VIN (X), VIN (W)
2.8 12V	1985.01	1987.12	-	-	-	6		X	X	JM5369	1	VIN (X), VIN (W)
2.8	1986.09	1989.12	101	137	-	6	-/6	AM16	AMU16	JM5290	3	VIN (W); OE 10467067
3.1	1988.01	1991.12	104	141	-	6	-/6	AM16	AMU16	JM5290	3	VIN (T); individual coils
3.1	1987.09	1988.12	104	141	-	6		X	X	JM5624	1	VIN (3); coil pack
3.1	1988.09	1990.12	101	137	-	6	-/6	AM16	AMU16	JM5290	3	VIN (T); individual coils
3.1 AWD	1989.09	1990.12	101	137	-	6	-/6	AM16	AMU16	JM5290	3	VIN (T); OE 10467067
3.1	1989.09	1991.12	101	137	-	6	-/6	AM16	AMU16	JM5290	3	VIN (T); OE 10467067
<b>BONNEVILLE</b>												
3.8 12V	1980.01	1986.12	82	112	-	6		X	X	JM5366	1	VIN (A)
3.8	1986.09	1987.12	82	110	-	6		X	X	JM5624	1	VIN (3); OE 12353801
3.8	1986.09	1987.12	82	110	-	6		X	X	JM5290	3	VIN (3)
3.8	1986.09	1988.12	112	152	-	6		X	X	JM5624	1	VIN (3); OE 12353801
3.8	1986.09	1988.12	112	152	-	6		X	X	JM5290	3	VIN (3)
3.8	1989.01	1991.12	112	152	-	6		X	X	JM5624	1	VIN (C); OE 12353801
3.8	1991.09	1992.12	112	150	-	6		X	X	JM5624	1	VIN (7); OE 12353801
3.8	1991.09	1999.12	112	150	-	6		X	X	JM5290	3	VIN (1), VIN (K), VIN (L)
3.8	1999.09	2005.12	112	150	-	6		X	X	JM5290	3	VIN (1), VIN (K)
4.1 16V	1982.01	1982.12	93	126	-	8		X	X	JM5366	1	VIN (4); USA
4.1 16V	1982.01	1982.12	93	126	-	8		X	X	JM5367	1	VIN (4); Canada
4.3 16V	1980.01	1981.12	90	122	-	8		X	X	JM5366	1	VIN (S)
4.6	2003.09	2005.12	205	279	-	8	-	-	-	JM5503	2	VIN (Y)
4.9 16V	1977.01	1980.12	101	137	-	8		X	X	JM5366	1	VIN (W), VIN (Y)
5.0 16V	1981.01	1981.12	104	141	-	8		X	X	JM5366	1	VIN (Y)
5.0 16V	1981.01	1981.12	108	147	-	8		X	X	JM5366	1	VIN (Y)
5.7 16V	1977.01	1980.12	78	106	-	8		X	X	JM5366	1	VIN (P), VIN (R) VIN (X)
6.6 16V	1975.01	1979.12	147	200	-	8		X	X	JM5366	1	VIN (N), VIN (R) VIN (S), VIN (Z)
7.5 16V	1975.01	1976.12	149	203	-	8		X	X	JM5366	1	VIN (W)
<b>FIREBIRD</b>												
3.8	1989.09	1989.12	78	105	-	6		X	X	JM5624	1	VIN (7); OE 12353801
5.7	1974.09	1979.12	116	158	-	8	-/8	AM99	AMU99	X	-	
5.7	1996.09	1997.12	116	158	-	8	1/8	AM36	AMU36	X	1	VIN (P); Formula
5.7	1996.09	1997.12	175	238	-	8	1/8	AM36	AMU36	X	1	VIN (P); Formula
<b>G5</b>												
2.2	2007.09	2009.12	110	150	-	4	-	-	-	JM5609	4	OE 12638824
2.2	2009.09	2010.12	110	148	-	4	-	-	-	JM5609	4	OE 12638824



													<b>PONTIAC USA</b>	
<b>G5</b>														
2.4	2006.09	2007.12	129	175	-		4	-	-	-	JM5609	4	OE 12638824	
2.4	2007.01	2008.12	129	175	LE5		4	-	-	-	JM5609	4	OE 12638824	
<b>G6</b>														
2.4	2005.09	2010.12	125	170	-		4	-	-	-	JM5609	4	OE 12638824	
2.4 Flexfuel	2009.09	2010.12	122	164	-		4	-	-	-	JM5609	4	OE 12638824	
3.5	2004.09	2005.12	149	203	-		6		X	X	JM5496	1	VIN (8)	
3.5	2006.09	2007.12	162	220	-		6		X	X	JM5496	1		
3.5	2006.09	2007.12	162	220	-		6		X	X	JM5496	1		
3.5	2007.09	2009.12	166	222	-		6		X	X	JM5496	1	VIN (N), VIN (K)	
3.5 Flexfuel	2008.09	2009.12	166	222	-		6		X	X	JM5496	1	VIN (N), VIN (K)	
3.5 Flexfuel	2008.09	2010.12	166	222	-		6		X	X	JM5496	1	VIN (K)	
3.9	2005.09	2007.12	169	230	-		6		X	X	JM5496	1	VIN (1)	
3.9	2007.09	2009.12	188	252	-		6		X	X	JM5496	1	VIN (1)	
<b>G8</b>														
6.0	2007.09	2008.12	269	366	-		8		X	X	JM5406	8	VIN (Y); sys. Mitsubishi	
6.0	2007.09	2008.12	269	366	-		8		X	X	JM5439	8	VIN (Y); sys. Delphi	
6.0	2007.09	2009.12	269	366	-		8		X	X	JM5406	8	VIN (Y); sys. Mitsubishi	
6.0	2007.09	2009.12	269	366	-		8		X	X	JM5439	8	VIN (Y); sys. Delphi	
6.2	2008.09	2009.12	310	421	-		8		X	X	JM5406	8	VIN (Y); sys. Mitsubishi	
6.2	2008.09	2009.12	310	421	-		8		X	X	JM5439	8	VIN (Y); sys. Delphi	
<b>GRAND AM</b>														
2.3 L4	1989.01	1994.12	-	-	140cid.		4		X	X	JM5384	2	JM1189; VIN (A); Coil Cover OE 10475706	
2.3 DOHC	1991.09	1995.12	86	117	-		4		X	-	JM5384	2	JM1189; VIN (D); Coil Cover OE 10475706	
2.3 SOHC	1991.09	1994.12	86	117	-		4		X	-	JM5384	2	JM1189; VIN (3); Coil Cover OE 10475706	
2.4 DOHC	1995.09	2001.12	112	152	-		4		X	-	JM5384	2	JM1189; VIN (T); Coil Cover OE 10475706	
3.0	1984.09	1987.12	92	125	-		6		X	X	JM5624	1	VIN (L); OE 12353801	
<b>GRAND PRIX</b>														
2.3	1989.09	1991.12	119	162	-		4	-	-	-	JM5384	2	JM1189; VIN (D); Coil Cover OE 10475706	
2.8	1987.09	1989.12	97	132	-		6	-/6	AM16	AMU16	JM5290	3	VIN (W)	
3.1	1988.09	1990.12	104	141	-		6	-/6	AM16	AMU16	JM5290	3	VIN (V); OE 10467067	
3.1	1988.09	1993.12	104	141	-		6	-/6	AM16	AMU16	JM5290	3	VIN (T); OE 10467067	
5.3	2004.09	2008.12	226	307	-		8		X	X	JM5406	8	VIN (C); sys. Mitsubishi	
5.3	2004.09	2008.12	226	307	-		8		X	X	JM5439	8	VIN (C); sys. Delphi	
<b>GTO</b>														
5.7	2003.09	2004.12	261	355	-		8		X	X	JM5406	8	sys. Mitsubishi	
5.7	2003.09	2004.12	261	355	-		8		X	X	JM5439	8	sys. Delphi	
6.0	2004.09	2006.12	299	407	-		8		X	X	JM5406	8	VIN (U); sys. Mitsubishi	
6.0	2004.09	2006.12	299	407	-		8		X	X	JM5439	8	VIN (U); sys. Delphi	
<b>MONTANA</b>														
3.4	1998.09	2005.12	138	188	-		6	-/6	AM58	AMU58	JM5290	3	VIN (E)	
3.4 AWD	1998.09	2005.12	138	188	-		6	-/6	AM58	AMU58	JM5290	3	VIN (E)	
3.5	2004.09	2005.12	149	203	-		6		X	X	JM5496	1	VIN (L)	
3.5 AWD	2004.09	2005.12	149	203	-		6		X	X	JM5496	1	VIN (L)	
3.9 SV6	2005.09	2009.12	179	243	-		6		X	X	JM5496	1	VIN (1)	
3.9 SV6 AWD	2005.09	2006.12	179	243	-		6		X	X	JM5496	1	VIN (1)	
3.9 SV6 Flexfuel	2007.09	2008.12	179	243	-		6		X	X	JM5496	1	VIN (W)	
<b>PORSUIT</b>														
2.4	2005.09	2006.12	128	171	-		4	-	-	-	JM5609	4	OE 12638824	
<b>SOLSTICE</b>														
2.0	2006.09	2009.12	194	264	-		4	-	-	-	JM5609	4	OE 12638824	
2.4	2005.09	2009.12	132	180	-		4	-	-	-	JM5609	4	OE 12638824	
2.4	2007.09	2008.12	129	173	-		4	-	-	-	JM5609	4	OE 12638824	
<b>SUNFIRE</b>														
2.3	1994.09	1995.12	112	152	-		4	-	-	-	JM5384	2	JM1189; VIN (D); Coil Cover OE 10475706	
2.4	1995.09	2001.12	112	152	-		4	-	-	-	JM5384	2	JM1189; VIN (T); Coil Cover OE 10475706	
<b>TEMPEST</b>														
3.1	1989.09	1991.12	104	141	-		6	-/6	AM16	AMU16	JM5290	3	VIN (T); OE 10467067	
<b>TORRENT</b>														
3.4	2005.09	2008.12	138	188	-		6		X	X	JM5496	1	VIN (F)	
3.4 AWD	2005.09	2008.12	138	188	-		6		X	X	JM5496	1	VIN (F)	



## PONTIAC USA

VIBE													
1.8 16V AWD	2003.01	2006.12	88	120		4	-	-	-	-	JM5018	4	VIN (8)
1.8 16V	2003.01	2007.12	88	120	-	4	-	-	-	-	JM5018	4	VIN (8)
1.8 16V	2003.01	2006.12	122	166	2ZZ-GE	4	-	-	-	-	JM5333	4	VIN (L)
1.8	2007.09	2008.12	94	126	-	4	-	-	-	-	JM5018	4	
1.8	2008.09	2010.12	99	132	-	4		X	X		JM5492	4	
2.4 AWD	2008.09	2010.12	118	158	-	4		X	X		JM5144	4	
2.4	2008.09	2010.12	118	158	-	4		X	X		JM5144	4	
WAVE													
1.6	2004.09	2005.12	77	105	-	4		X	X		JM5079	1	
1.6	2007.09	2008.12	80	107	-	4		X	X		JM5079	1	
WAVE 5													
1.6	2005.09	2007.12	79	107	-	4		X	X		JM5079	1	

## PORSCHE USA

356 A													
1.3	1956.01	1957.12	-	-	-	4		X	X		JM5355	1	
1.5	1955.09	1959.12	37	50	-	4		X	X		JM5355	1	
1.6	1955.09	1959.12	37	50	-	4		X	X		JM5355	1	
1.6	1958.01	1959.12	-	-	-	4		X	X		JM5355	1	
356 B													
1.6	1959.09	1962.12	52	70	-	4		X	X		JM5355	1	
356 C													
1.6	1963.09	1964.12	-	-	-	4		X	X		JM5355	1	
356SC													
1.6	1963.09	1965.12	-	-	-	4		X	X		JM5355	1	
911													
1.6	1965.01	1969.12	-	-	-	4		X	X		JM5355	1	
1.6	1965.01	1969.12	-	-	-	4		X	X		JM5355	1	VIN (0)
2.0	1965.01	1969.12	-	-	-	6		X	X		JM5355	1	
912													
2.0 E	1975.09	1976.12	64	87	-	4		X	X		JM5355	1	VIN (0)
914													
1.7	1970.01	1973.12	-	-	-	4		X	X		JM5335	1	for BOSCH GT40T R1=3.0[Ω], R2=8.5[kΩ]
1.8	1974.01	1974.12	-	-	-	4		X	X		JM5335	1	for BOSCH GT40T R1=3.0[Ω], R2=8.5[kΩ]
1.8	1975.01	1975.12	-	-	-	4		X	X		JM5335	1	for BOSCH GT40T R1=3.0[Ω], R2=8.5[kΩ]
2.0	1974.01	1974.12	-	-	-	4		X	X		JM5335	1	VIN (2); BOSCH GT40T R1=3.0[Ω], R2=8.5[kΩ]
2.0	1975.01	1975.12	-	-	-	4		X	X		JM5335	1	VIN (2); BOSCH GT40T R1=3.0[Ω], R2=8.5[kΩ]
2.0	1976.01	1976.12	-	-	-	4		X	X		JM5335	1	for BOSCH GT40T R1=3.0[Ω], R2=8.5[kΩ]
CAYENNE													
3.2 DOHC 195 cid.	2004.01	2007.12	-	-	-	6		X	X		JM5066	6	VIN (A)
3.2 DOHC 195 cid.	2008.01	-->	-	-	M 55.01	6		X	X		JM5066	6	VIN (A)

## QVALE USA

MANGUSTA													
4.6	2000.09	2002.12	239	325	-	8	-	-	-	-	JM5088	8	JM1193

## RENAULT USA

17													
1.6	1974.01	1974.12	-	-	-	4		X	X		JM5335	1	for BOSCH GT40T R1=3.0[Ω], R2=8.5[kΩ]
1.6 8V	1975.01	1979.12	-	-	-	4		X	X		JM5335	1	for BOSCH GT40T R1=3.0[Ω], R2=8.5[kΩ]
LECAR													
1.3	1977.01	1979.12	-	-	-	4		X	X		JM5335	1	for BOSCH GT40T R1=3.0[Ω], R2=8.5[kΩ]
1.4	1980.01	1983.12	-	-	-	4		X	X		JM5335	1	for BOSCH GT40T R1=3.0[Ω], R2=8.5[kΩ]

## RILEY USA

1500													
1.5	1950.01	1956.12	-	-	-	4		X	X		JM5335	1	for BOSCH GT40T R1=3.0[Ω], R2=8.5[kΩ]
1.5	1958.01	1963.12	-	-	-	4		X	X		JM5335	1	for BOSCH GT40T R1=3.0[Ω], R2=8.5[kΩ]



**RILEY USA**

<b>2600</b>											
2.6	1957.01	1961.12	-	-	-	6		X	X	JM5335	1 for BOSCH GT40T R1=3.0[Ω], R2=8.5[kΩ]
<b>PATHFINDER</b>											
2.4	1954.01	1957.12	-	-	-	4		X	X	JM5335	1 for BOSCH GT40T R1=3.0[Ω], R2=8.5[kΩ]

**ROVER USA**

<b>60</b>											
2.0	1954.01	1958.12	-	-	-	4		X	X	JM5335	1 for BOSCH GT40T R1=3.0[Ω], R2=8.5[kΩ]
<b>75</b>											
2.1	1950.01	1954.12	-	-	-	6		X	X	JM5335	1 for BOSCH GT40T R1=3.0[Ω], R2=8.5[kΩ]
2.2	1955.01	1958.12	-	-	-	6		X	X	JM5335	1 for BOSCH GT40T R1=3.0[Ω], R2=8.5[kΩ]
<b>90</b>											
2.6	1954.01	1958.12	-	-	-	6		X	X	JM5335	1 for BOSCH GT40T R1=3.0[Ω], R2=8.5[kΩ]
<b>100</b>											
2.6	1959.01	1963.12	-	-	-	6		X	X	JM5335	1 for BOSCH GT40T R1=3.0[Ω], R2=8.5[kΩ]
<b>105</b>											
2.6	1957.01	1959.12	-	-	-	6		X	X	JM5335	1 for BOSCH GT40T R1=3.0[Ω], R2=8.5[kΩ]
<b>2000</b>											
2.0	1968.01	1971.12	-	-	-	4		X	X	JM5335	1 for BOSCH GT40T R1=3.0[Ω], R2=8.5[kΩ]
2.0	1970.01	1971.12	-	-	-	4		X	X	JM5355	1
<b>3000</b>											
3.0	1959.01	1963.12	-	-	-	6		X	X	JM5335	1 for BOSCH GT40T R1=3.0[Ω], R2=8.5[kΩ]
<b>3500</b>											
3.5	1968.09	1971.12	137	184	-	8		X	X	JM5355	1

**SAAB USA**

<b>9-2X</b>											
2.0 AWD	2004.09	2005.12	169	227	EJ205	4	-	-	-	JM5399	4
2.5 AWD	2006.01	2006.12	123	167	EJ253	4	-	-	-	JM5398	4 OE 22433-AA480
2.5 AWD	2006.01	2006.12	123	167	EJ255	4	-	-	-	JM5398	4 OE 22433-AA480
2.5 AWD	2004.09	2005.12	123	167	EJ253	4		X	X	JM5400	1 OE 22433-AA580
<b>9-3</b>											
2.8	2005.09	2006.12	186	250	-	6	-	-	-	JM5429	6 VIN (U); OE 12613057
2.8	2005.09	2009.12	186	250	-	6	-	-	-	JM5429	6 VIN (U); OE 12613057
2.8	2005.09	2008.12	187	250	-	6	-	-	-	JM5429	6 VIN (U); OE 12613057
2.8 AWD	2005.09	2008.12	187	250	-	6	-	-	-	JM5426	6 VIN (U); OE 12613057
<b>9-7X</b>											
4.2 AWD	2006.01	2007.12	205	275	-	6	-	-	-	JM5405	6 VIN (S)
4.2 i AWD	2007.09	2008.12	220	295	256cid.	6	-	-	-	JM5405	6
5.3 AWD	2004.09	2007.12	224	300	-	8		X	X	JM5406	8 VIN (M); sys. Mitsubishi
5.3 AWD	2004.09	2007.12	224	300	-	8		X	X	JM5439	8 VIN (M); sys. Delphi
5.3 AWD	2008.01	2008.12	224	300	-	8		X	X	JM5439	8 VIN (M); sys. Delphi
5.3 AWD	2008.01	2009.12	224	300	-	8		X	X	JM5406	8 VIN (M); sys. Mitsubishi VIN (M)
5.3 AWD	2009.01	2009.12	224	300	-	8		X	X	JM5439	8 VIN (M); sys. Delphi
5.3 AWD	2008.01	2008.12	224	300	-	8		X	X	JM5406	8 VIN (M); sys. Mitsubishi
6.0 AWD	2007.09	2008.12	291	390	364cid.	8		X	X	JM5406	8
6.0 AWD	2007.09	2008.12	291	390	364cid.	8		X	X	JM5439	8
6.0 AWD	2007.09	2008.12	291	390	364cid.	8		X	X	JM5406	8
6.0 AWD	2007.09	2008.12	291	390	364cid.	8		X	X	JM5439	8
<b>93</b>											
0.7	1957.01	1957.12	-	-	-	3		X	X	JM5335	1 for BOSCH GT40T R1=3.0[Ω], R2=8.5[kΩ]
<b>95</b>											
0.8	1959.01	1967.12	-	-	-	3		X	X	JM5335	1 for BOSCH GT40T R1=3.0[Ω], R2=8.5[kΩ]; Dist. VJ, VJU
0.8	1966.01	1967.12	-	-	-	3		X	X	JM5335	1 for BOSCH GT40T R1=3.0[Ω], R2=8.5[kΩ]; Dist. VJ, VJU
0.8	1968.01	1968.12	-	-	-	3		X	X	JM5335	1 for BOSCH GT40T R1=3.0[Ω], R2=8.5[kΩ]



## SAAB USA

95												
1.5	1970.01	1970.12	30	40	-	4		X	X	JM5210	1	Dist. Bosch (internal resistor)
1.5	1970.01	1970.12	30	40	-	4		X	X	JM5355	1	Dist. Lucas (external resistor)
1.5	1968.01	1970.12	-	-	-	4		X	X	JM5335	1	for BOSCH GT40T R1=3.0[Ω], R2=8.5[kΩ]
1.7	1970.09	1973.12	49	66	-	4		X	X	JM5210	1	Dist. 0231167039 (internal resistor)
1.7	1970.09	1973.12	49	66	-	4		X	X	JM5355	1	Dist. 0231176010 / 0231176110 (external resistor)
1.7	1971.01	1973.12	-	-	-	4		X	X	JM5335	1	for BOSCH GT40T R1=3.0[Ω], R2=8.5[kΩ] Dist. BOSCH 0231167039
96												
0.8	1967.09	1968.12	30	40	-	3	1/3	SBS13	SBU13	JM5335	1	for BOSCH GT40T R1=3.0[Ω], R2=8.5[kΩ]
0.8	1965.09	1967.12	34	46	-	3	1/3	SBS13	SBU13	JM5335	1	for BOSCH GT40T R1=3.0[Ω], R2=8.5[kΩ]
0.8	1966.01	1967.12	-	-	-	3		X	X	JM5335	1	for BOSCH GT40T R1=3.0[Ω], R2=8.5[kΩ]
1.5	1970.01	1970.12	30	40	-	4		X	X	JM5210	1	Dist. Bosch (internal resistor)
1.5	1970.01	1970.12	30	40	-	4		X	X	JM5355	1	Dist. Lucas (external resistor)
1.5	1968.01	1970.12	-	-	-	4		X	X	JM5335	1	for BOSCH GT40T R1=3.0[Ω], R2=8.5[kΩ]
1.7	1970.09	1973.12	48	65	-	4		X	X	JM5210	1	Dist. 0231167039 (internal resistor)
1.7	1970.09	1973.12	48	65	-	4		X	X	JM5355	1	Dist. 0231176010 / 0231176110 (external resistor)
1.7	1971.01	1973.12	-	-	-	4		X	X	JM5335	1	for BOSCH GT40T R1=3.0[Ω], R2=8.5[kΩ] Dist. BOSCH 0231167039
99												
1.7	1970.01	1971.12	64	86	-	4		X	X	JM5210	1	Dist. Bosch (internal resistor); Carb.
1.7	1970.01	1971.12	64	86	-	4		X	X	JM5355	1	Dist. Lucas (external resistor); Carb.
1.7	1969.01	1971.12	-	-	-	4		X	X	JM5335	1	for BOSCH GT40T R1=3.0[Ω], R2=8.5[kΩ] Dist. BOSCH 0231167039
1.9	1970.09	1972.12	64	86	-	4		X	X	JM5355	1	Carb.
1.9	1971.01	1971.12	64	86	-	4		X	X	JM5334	1	GT40RT
1.9	1970.09	1972.12	64	86	-	4		X	X	JM5355	1	Inj.
2.0	1971.09	1974.12	64	86	-	4		X	X	JM5355	1	Carb.
2.0	1972.01	1974.12	64	86	-	4		X	X	JM5334	1	GT40RT
2.0	1971.09	1974.12	64	86	-	4		X	X	JM5355	1	Inj.
2.0	1974.09	1977.12	74	100	-	4		X	X	JM5355	1	
2.0	1974.09	1977.12	74	100	-	4		X	X	JM5355	1	
2.0	1974.09	1977.12	74	100	-	4		X	X	JM5355	1	
2.0	1975.09	1977.12	74	100	-	4		X	X	JM5355	1	
2.0	1974.09	1977.12	107	145	-	4		X	X	JM5355	1	
MONTE CARLO												
0.8	1966.01	1967.12	-	-	-	3		X	X	JM5335	1	for BOSCH GT40T R1=3.0[Ω], R2=8.5[kΩ]
1.5	1967.01	1967.12	-	-	-	4		X	X	JM5335	1	for BOSCH GT40T R1=3.0[Ω], R2=8.5[kΩ]
SONETT												
0.8	1967.01	1967.12	-	-	-	3		X	X	JM5335	1	for BOSCH GT40T R1=3.0[Ω], R2=8.5[kΩ]
1.5	1968.01	1969.12	-	-	-	4		X	X	JM5335	1	for BOSCH GT40T R1=3.0[Ω], R2=8.5[kΩ]
1.7	1969.09	1971.12	49	66	-	4		X	X	JM5210	1	Dist. Bosch (internal resistor)
1.7	1969.09	1971.12	49	66	-	4		X	X	JM5355	1	Dist. Lucas (external resistor)
1.7	1972.12	1974.12	49	66	-	4		X	X	JM5355	1	
1.7	1970.01	1974.12	-	-	-	4		X	X	JM5335	1	for BOSCH GT40T R1=3.0[Ω], R2=8.5[kΩ] Dist. BOSCH 0231167039





SATURN												
<b>ION</b>												
2.0	2003.09	2007.12	153	208	-	4	-	-	-	JM5478	4	
<b>SATURN USA</b>												
<b>AURA</b>												
2.4	2006.09	2009.12	122	166	-	4	-	-	-	JM5609	4	OE 12638824
2.4	2007.09	2009.12	126	171	-	4	-	-	-	JM5609	4	OE 12638824
3.5	2006.09	2008.12	163	222	-	6		X	X	JM5496	1	VIN (N)
<b>ION</b>												
2.2	2006.09	2007.12	-	-	-	4	-	-	-	JM5609	4	OE 12638824
2.2	2007.01	2007.12	104	141	-	4	-	-	-	JM5609	4	OE 12638824
2.4	2005.09	2007.12	127	173	-	4	-	-	-	JM5609	4	OE 12638824
<b>OUTLOOK</b>												
3.6	2009.01	2009.12	198	269	-	6	-	-	-	JM5426	6	OE 12613057
3.6 AWD	2009.01	2009.12	198	269	-	6	-	-	-	JM5426	6	OE 12613057
<b>RELAY</b>												
3.5	2004.09	2006.12	146	199	-	6		X	X	JM5496	1	RELAY-2; VIN (L)
3.5	2004.09	2006.12	146	199	-	6		X	X	JM5496	1	RELAY-3; VIN (L)
3.5	2004.09	2005.12	149	203	-	6		X	X	JM5496	1	RELAY-2; VIN (L)
3.5 AWD	2004.09	2005.12	149	203	-	6		X	X	JM5496	1	RELAY-2; VIN (L)
3.5	2004.09	2005.12	149	203	-	6		X	X	JM5496	1	RELAY-3; VIN (L)
3.5 AWD	2004.09	2005.12	149	203	-	6		X	X	JM5496	1	RELAY-3; VIN (L)
3.9 AWD	2005.12	2006.09	175	238	-	6		X	X	JM5496	1	RELAY-3; VIN (1)
3.9	2006.09	2007.12	179	243	-	6		X	X	JM5496	1	RELAY-1; VIN (1) VIN (W)
3.9	2006.09	2007.12	179	243	-	6		X	X	JM5496	1	RELAY-2; VIN (1) VIN (W)
3.9	2006.09	2007.12	179	243	-	6		X	X	JM5496	1	RELAY-3; VIN (1) VIN (W)
<b>SKY</b>												
2.0	2006.09	2009.12	194	264	-	4	-	-	-	JM5609	4	OE 12638824
2.0	2009.09	2010.12	194	264	-	4	-	-	-	JM5609	4	OE 12638824
2.4	2006.09	2009.12	132	180	-	4	-	-	-	JM5609	4	OE 12638824
2.4	2009.09	2010.12	129	173	-	4	-	-	-	JM5609	4	OE 12638824
<b>VUE</b>												
2.4	2007.09	2008.12	122	164	-	4	-	-	-	JM5609	4	
2.4 AWD	2007.09	2008.12	122	164	-	4	-	-	-	JM5609	4	
2.4 Hybrid	2007.09	2008.12	127	170	-	4	-	-	-	JM5609	4	
2.4	2008.09	2010.12	126	169	-	4	-	-	-	JM5609	4	
2.4 AWD	2008.09	2010.12	126	169	-	4	-	-	-	JM5609	4	
2.4 Hybrid	2008.09	2009.12	128	172	-	4	-	-	-	JM5609	4	
3.5	2007.09	2008.12	160	215	-	6		X	X	JM5496	1	VIN (N)
3.5 AWD	2007.09	2008.12	160	215	-	6		X	X	JM5496	1	VIN (N)
3.5	2008.09	2009.12	166	222	-	6		X	X	JM5496	1	VIN (N)
3.5 AWD	2008.09	2009.12	166	222	-	6		X	X	JM5496	1	VIN (N)
3.5	2009.09	-->	187	250	-	6		X	X	JM5496	1	VIN (N)
3.5 AWD	2009.09	-->	187	250	-	6		X	X	JM5496	1	VIN (N)
<b>SCION USA</b>												
<b>XD</b>												
1.8	2007.09	2011.12	95	128	-	4		X	X	JM5492	4	
<b>SHELBY</b>												
<b>SERIES 1</b>												
4.0	1998.01	2000.12	186	253	-	8		X	X	JM5290	4	
<b>SIMCA USA</b>												
<b>1000</b>												
0.9	1962.01	1962.12	-	-	-	4		X	X	JM5335	1	for BOSCH GT40T R1=3.0[Ω], R2=8.5[kΩ]
<b>ARIANE</b>												
1.3	1959.01	1959.12	-	-	-	4		X	X	JM5335	1	for BOSCH GT40T R1=3.0[Ω], R2=8.5[kΩ]
1.3	1959.01	1959.12	-	-	-	4		X	X	JM5335	1	for BOSCH GT40T R1=3.0[Ω], R2=8.5[kΩ]
2.4	1959.01	1959.12	-	-	-	8		X	X	JM5335	1	for BOSCH GT40T R1=3.0[Ω], R2=8.5[kΩ]



### SIMCA USA

ARONDE												
1.2	1955.01	1956.12	-	-	-	4		X	X	JM5335	1	for BOSCH GT40T R1=3.0[Ω], R2=8.5[kΩ]
1.3	1956.01	1959.12	-	-	-	4		X	X	JM5335	1	for BOSCH GT40T R1=3.0[Ω], R2=8.5[kΩ]
1.3	1956.01	1959.12	-	-	-	4		X	X	JM5335	1	for BOSCH GT40T R1=3.0[Ω], R2=8.5[kΩ]
VEDETTE												
2.4	1956.01	1959.12	-	-	-	8		X	X	JM5335	1	for BOSCH GT40T R1=3.0[Ω], R2=8.5[kΩ]

### SINGER USA

GAZELLE												
1.5	1957.01	1958.12	-	-	-	4		X	X	JM5335	1	for BOSCH GT40T R1=3.0[Ω], R2=8.5[kΩ]

### STANDARD USA

VANGUARD												
2.1	1950.01	1952.12	-	-	-	4		X	X	JM5335	1	for BOSCH GT40T R1=3.0[Ω], R2=8.5[kΩ]

### STUDEBAKER USA

CHAMP												
2.8 170cid	1961.01	1961.12	-	-	-	6		X	X	JM5335	1	for BOSCH GT40T R1=3.0[Ω], R2=8.5[kΩ]
LARK												
2.8	1959.01	1963.12	-	-	-	6		X	X	JM5335	1	for BOSCH GT40T R1=3.0[Ω], R2=8.5[kΩ]
SILVER HAWK												
2.8	1959.01	1959.12	-	-	-	6		X	X	JM5335	1	for BOSCH GT40T R1=3.0[Ω], R2=8.5[kΩ]

### SUBARU USA

1400 DL												
1.4 8V	1975.01	1976.12	-	-	-	4		X	X	JM5334	1	GT40RT
1.4 8V AWD	1975.01	1976.12	-	-	-	4		X	X	JM5334	1	GT40RT
BAJA												
2.5 AWD	2004.01	2006.12	123	167	EJ255	4	-	-	-	JM5398	4	OE 22433-AA480
DELUXE												
1.4	1972.09	1973.12	45	61	-	4		X	X	JM5355	1	
DL												
1.6 8V	1977.01	1979.12	-	-	EA71	4		X	X	JM5334	1	GT40RT
1.6 8V AWD	1977.01	1979.12	-	-	EA71	4		X	X	JM5334	1	GT40RT
FORESTER												
2.5 X	2005.01	2007.12	123	165	EJ253	4		X	X	JM5400	1	OE 22433-AA580
2.5 X	2006.01	2007.12	123	165	EJ255	4		X	X	JM5398	4	OE 22433-AA480
2.5 AWD	2007.09	2010.12	123	165	-	4	-/4	JP187	JPE187	JM5400	1	OE 22433-AA500
2.5 AWD	2007.09	2010.12	123	165	EJ255	4	-	-	-	JM5398	4	OE 22433-AA480
2.5 AWD	2007.09	2012.12	171	230	-	4	-/4	JP187	JPE187	JM5400	1	OE 22433-AA500
2.5 AWD	2007.09	2012.12	171	230	EJ255	4	-	-	-	JM5398	4	OE 22433-AA480
2.5 AWD	2010.09	-->	127	170	-	4	-	-	-	JM5398	4	OE 22433-AA480
IMPREZA												
1.8 AWD	1992.09	1997.12	82	112	-	4		X	X	JM5476	1	VIN (2) OE 22433-AA230 OE 22433-AA360
2.0 WRX AWD	2001.09	2003.12	169	230	Eng. EJ205	4	-	-	-	JM5397	4	VIN (2) OE 22433-AA421
2.0 WRX AWD	2004.01	2004.12	169	230	Eng. EJ205	4	-	-	-	JM5399	4	OE 22433-AA451
2.5 WRX AWD	2004.01	2006.12	171	233	EJ257	4	-	-	-	JM5398	4	OE 22433-AA480
2.5 AWD	2007.09	2008.12	167	224	EJ253	4		X	X	JM5400	1	Canada
2.5 AWD	2007.09	2008.12	167	224	EJ255	4	-	-	-	JM5398	4	USA OE 22433-AA480
2.5 AWD	2007.09	2008.12	167	224	EJ257	4	-	-	-	JM5398	4	USA & Canada OE 22433-AA480
2.5 AWD	2008.09	2010.12	198	265	EJ253	4		X	X	JM5400	1	
2.5 AWD	2008.09	2011.12	198	265	EJ255	4		X	X	JM5398	4	OE 22433-AA480
2.5 AWD	2008.09	2011.12	198	265	EJ257	4		X	X	JM5398	4	OE 22433-AA480
2.5 AWD	2008.09	2010.12	228	310	EJ253	4		X	X	JM5400	1	
2.5 AWD	2008.09	-->	228	310	EJ255	4		X	X	JM5398	4	OE 22433-AA480
2.5 AWD	2008.09	-->	228	310	EJ257	4		X	X	JM5398	4	OE 22433-AA480
2.5 AWD	2011.09	-->	171	233	EJ255	4		X	X	JM5398	4	OE 22433-AA480
2.5 AWD	2011.09	-->	171	233	EJ257	4		X	X	JM5398	4	OE 22433-AA480



**SUBARU USA**

<b>LEGACY</b>													
2.2	1989.09	1994.12	97	132	-		4		X	X	JM5178	1	VIN (6) OE 22433-AA240 OE 22433-AA370
2.2 AWD	1989.09	1994.12	97	132	-		4		X	X	JM5178	1	VIN (6) OE 22433-AA240 OE 22433-AA370
2.2 AWD	1991.09	1992.12	119	160	-		4		X	X	JM5476	1	OE 22433-AA230 OE 22433-AA360 OE 22433-AA360
2.2 AWD	1991.09	1994.12	122	165	-		4		X	X	JM5476	1	VIN (6) OE 22433-AA230 OE 22433-AA360
2.2	1993.09	1996.12	97	132	-		4		X	X	JM5178	1	OE 22433-AA240 OE 22433-AA370
2.2 AWD	1993.09	1996.12	97	132	-		4		X	X	JM5178	1	OE 22433-AA240 OE 22433-AA370
2.2 AWD	1993.09	1994.12	122	165	-		4		X	X	JM5476	1	OE 22433-AA230 OE 22433-AA360
2.2	1997.01	1999.12	97	132	-		4		X	X	JM5425	1	OE 22433-AA400
2.2 AWD	1997.01	1999.12	97	132	-		4		X	X	JM5425	1	OE 22433-AA400
2.5 AWD	2007.09	2008.12	123	165	EJ253		4		X	X	X	1	
2.5 AWD	2007.09	2008.12	171	230	EJ255		4		X	X	JM5398	4	OE 22433-AA480
2.5 AWD	2009.09	2009.12	127	170	EL253		4		X	X	JM5400	1	OE 22433-AA580
2.5 AWD	2009.09	2009.12	198	265	EJ255		4		X	X	JM5398	4	OE 22433-AA480
2.5 AWD	2009.09	2009.12	198	265	EJ257		4		X	X	JM5398	4	OE 22433-AA480
<b>OUTBACK</b>													
2.5 AWD	2006.09	2009.12	171	230	EJ255		4	-	-	-	JM5398	4	OE 22433-AA480
2.5 AWD	2006.09	2009.12	171	230	EJ253		4		X	X	JM5400	1	

**SUNBEAM USA**

<b>ALPINE</b>													
1.5	1960.01	1961.12	-	-	-		4		X	X	JM5335	1	for BOSCH GT40T R1=3.0[Ω], R2=8.5[kΩ]
1.6	1961.01	1965.12	-	-	-		4		X	X	JM5335	1	for BOSCH GT40T R1=3.0[Ω], R2=8.5[kΩ]
1.7	1965.01	1967.12	-	-	-		4		X	X	JM5335	1	for BOSCH GT40T R1=3.0[Ω], R2=8.5[kΩ]
2.3	1953.01	1955.12	-	-	-		4		X	X	JM5335	1	for BOSCH GT40T R1=3.0[Ω], R2=8.5[kΩ]
<b>MK III</b>													
2.3	1955.01	1955.12	-	-	-		4		X	X	JM5335	1	for BOSCH GT40T R1=3.0[Ω], R2=8.5[kΩ]
<b>RAPIER</b>													
1.4	1956.01	1958.12	-	-	-		4		X	X	JM5335	1	for BOSCH GT40T R1=3.0[Ω], R2=8.5[kΩ]
1.5	1958.01	1961.12	-	-	-		4		X	X	JM5335	1	for BOSCH GT40T R1=3.0[Ω], R2=8.5[kΩ]
1.6	1961.01	1965.12	-	-	-		4		X	X	JM5335	1	for BOSCH GT40T R1=3.0[Ω], R2=8.5[kΩ]
1.7	1965.01	1967.12	-	-	-		4		X	X	JM5335	1	for BOSCH GT40T R1=3.0[Ω], R2=8.5[kΩ]
<b>SUNBEAM - TALBOT</b>													
1.2	1950.01	1950.12	-	-	-		4		X	X	JM5335	1	for BOSCH GT40T R1=3.0[Ω], R2=8.5[kΩ]
2.3	1951.01	1954.12	-	-	-		4		X	X	JM5335	1	for BOSCH GT40T R1=3.0[Ω], R2=8.5[kΩ]
<b>TIGER</b>													
4.3	1963.09	1967.12	122	166	-		8		X	X	JM5335	1	for BOSCH GT40T R1=3.0[Ω], R2=8.5[kΩ]
4.7	1963.09	1967.12	149	203	-		8		X	X	JM5335	1	for BOSCH GT40T R1=3.0[Ω], R2=8.5[kΩ]

**SUZUKI USA**

<b>EQUATOR</b>													
2.5	2008.09	2009.12	113	152	-		4		X	X	JM5483	4	OE 22448-EA000
2.5	2008.09	2011.12	113	152	-		4		X	X	JM5483	4	OE 22448-EA000
4.0	2008.09	2011.12	195	261	-		6		X	X	JM5331	6	OE 33400-82Z00
4.0 4WD	2008.09	2011.12	195	261	-		6		X	X	JM5331	6	OE 33400-82Z00
<b>FORENZA</b>													
2.0	2003.09	2006.12	89	121	-		4		X	X	JM5079	1	
2.0	2004.09	2008.12	94	128	-		4		X	X	JM5079	1	
2.0 DOHC	2004.01	2008.12	-	-	-		4		X	X	JM5079	1	
2.0 DOHC	2005.01	-->	-	-	-		4		X	X	JM5079	1	



## SUZUKI USA

GRAND VITARA												
2.7 V6	2006.01	2009.12	-	-	-	6		X	X	JM5374	6	OE 33400-65J00
RENO												
2.0	2004.09	2007.12	94	128	-	4		X	X	JM5079	1	
2.0 DOHC	2005.01	-->	-	-	-	4		X	X	JM5079	1	
2.0 DOHC	2006.01	2008.12	-	-	-	4		X	X	JM5079	1	
SA 310												
1.0	1984.09	1985.12	36	48	-	3		X	X	JM5623	1	OE 33410-80010
SJ410												
1.0	1982.09	1984.12	34	45	-	4		X	X	JM5623	1	OE 33410-80010
1.0 4WD	1982.01	1982.12	34	45	-	4		X	X	JM5623	1	OE 33410-80010
SWIFT												
1.3	1997.09	2001.12	59	79	-	4		X	X	JM5472	2	OE 33410-66D10 VIN (2)
SX4												
2.0 4WD	2007.01	2010.12	-	-	-	4	-	-	-	JM5374	4	OE 33400-65J00
2.0	2008.01	2010.12	-	-	-	4	-	-	-	JM5374	4	OE 33400-65J00
2.0 4WD	2008.01	2008.12	-	-	-	4	-	-	-	JM5374	4	OE 33400-65J00
VITARA												
1.6	1998.09	2001.12	72	98	-	4		X	X	JM5472	2	OE 33410-66D10
1.6 4WD	1998.09	2001.12	72	98	-	4		X	X	JM5472	2	OE 33410-66D10

## TALBOT

180												
2.0	1973.02	1977.09	81	110	7T2	4	1/4	JP325	JPE325	X	-	
1307-1510												
1.3	1975.07	1980.01	50	68	G1	4	1/4	CPS5	CPU5	JM5355	1	(TZ)
1.3	1975.09	1979.07	44	60	-	4	1/4	CPS5	CPU5	JM5355	1	
1.3	1978.01	1981.08	40	54	6G1D	4	1/4	CPS5	CPU5	JM5465	1	OE 0522335500
1.4	1978.11	1979.07	55	75	6Y2, 6Y2D	4	1/4	CPS5	CPU5	JM5465	1	OE 0522335500
1.4	1978.11	1979.07	63	86	6Y2	4	1/4	CPS5	CPU5	JM5465	1	OE 0522335500
1.4	1980.01	1982.12	51	69	6G1	4	1/4	CPS5	CPU5	JM5355	1	(TZ)
1.4	1980.01	1981.04	55	75	6Y2D	4	1/4	CPS5	CPU5	JM5355	1	(TZ)
1.4	1980.01	1981.04	63	86	6Y2	4	1/4	CPS5	CPU5	JM5355	1	(TZ)
1.6	1978.10	1980.01	65	88	6J2	4	1/4	CPS5	CPU5	JM5355	1	(TZ)
1.6	1980.11	1983.12	54	73	6J1	4	1/4	CPS5	CPU5	JM5355	1	(TZ)
1.6	1981.07	1982.06	66	90	6J2A	4	1/4	CPS5	CPU5	JM5465	1	OE 0522335500
AVENGER												
1.3	1970.02	1981.07	44	60	-	4	1/4	CPS5	CPU5	JM5210	1	
1.6	1970.02	1981.07	51	70	-	4	1/4	CPS5	CPU5	JM5210	1	
1.6	1970.02	1981.07	59	81	-	4	1/4	CPS5	CPU5	JM5210	1	
EXPRESS												
1.8	1981.07	1990.10	51	69	XM7T	4	1/4	CPS19	CPU19	X	-	
2.0	1982.07	1994.10	57	78	XN1TA	4	1/4	CPS19	CPU19	X	-	
HORIZON												
1.1	1979.01	1984.09	40	54	E1B	4	1/4	CPS5	CPU5	JM5465	1	
1.1	1979.01	1984.09	43	58	-	4	1/4	CPS5	CPU5	X	-	
1.3	1978.02	1980.01	47	64	-	4	1/4	CPS5	CPU5	X	-	
1.3	1978.02	1980.01	50	68	2G1	4	1/4	CPS5	CPU5	X	-	
1.3	1978.09	1984.09	43	58	2G1-BTC	4	1/4	CPS5	CPU5	JM5465	1	OE 0522335500
1.3	1981.09	1985.01	40	54	2G1-BTC	4	1/4	CPS5	CPU5	JM5465	1	OE 0522335500

## TOYOTA USA

4 RUNNER												
2.4 4WD	1983.09	1984.12	87	118	22R	4		X	X	JM5448	1	OE 90919-02106
2.4 SOHC SR5	1995.01	1995.12	-	-	22RE	4		X	X	JM5149	1	VIN (R)
2.7 DOHC	1996.01	1997.12	-	-	3RZ-FE	4		X	X	JM5150	1	VIN (M)
2.7	1997.01	1999.12	112	152	3RZ-FE	4		X	X	JM5393	1	1 & 4 cyl.; VIN (M)
2.7	1997.01	1999.12	112	152	3RZ-FE	4		X	X	JM5412	1	2 & 3 cyl.; VIN (M)
2.7 AWD	1997.01	1999.12	112	152	3RZ-FE	4		X	X	JM5393	1	1 & 4 cyl.; VIN (M)
2.7 AWD	1997.01	1999.12	112	152	3RZ-FE	4		X	X	JM5412	1	2 & 3 cyl.; VIN (M)
2.7	2000.01	2000.12	112	152	3RZ-FE	4	-	-	-	JM5183	4	
2.7 AWD	2000.01	2000.12	112	152	3RZ-FE	4	-	-	-	JM5183	4	
2.7	2009.09	2010.12	117	157	2TR-FE	4	-	-	-	JM5416	4	
2.7 4WD	2009.09	2010.12	117	157	2TR-FE	4	-	-	-	JM5416	4	
3.0 4WD	1988.09	1991.12	112	152	3VZ-E	6	1/6	JP362	JPE362	JM5148	1	OE 90919-02185
3.0 V6 SOHC SR5	1989.01	1991.12	-	-	3VZ-E	6		X	X	JM5148	1	VIN (V)



TOYOTA USA												
<b>4 RUNNER</b>												
3.0	1989.09	1991.12	112	152	3VZ-E	6	1/6	JP362	JPE362	JM5148	1	OE 90919-02185
3.0 V6 SOHC SR5	1992.12	1995.12	-	-	3VZ-E	6		X	X	JM5149	1	VIN (V)
3.4	1995.09	1998.12	137	186	5VZ-FE	6		X	X	JM5143	3	OE 90919-02212
3.4 4WD	1995.09	1998.12	137	186	5VZ-FE	6		X	X	JM5143	3	OE 90919-02212
4.0	2005.09	2006.12	176	239	1GR-FE	6	-	-	-	JM5416	6	
4.0 4WD	2005.09	2006.12	176	239	1GR-FE	6	-	-	-	JM5416	6	
4.7	2002.09	2006.12	175	238	2UZ-FE	8	-	-	-	JM5184	8	OE 90919-02230
4.7 4WD	2002.09	2006.12	175	238	2UZ-FE	8	-	-	-	JM5184	8	OE 90919-02230
4.7	2006.09	2009.12	194	260	2UZ-FE	8	-	-	-	JM5184	8	OE 90919-02230
4.7 AWD	2006.09	2009.12	194	260	2UZ-FE	8	-	-	-	JM5184	8	OE 90919-02230
<b>AVALON</b>												
3.0	1994.09	1995.12	143	194	1MZ-FE	6	-	-	-	JM5394	6	VIN (G) OE 90919-02214
3.0	1996.01	1999.12	143	194	1MZ-FE	6		X	X	JM5427	3	VIN (F) OE 90919-02215
3.0	2000.01	2004.12	143	194	1MZ-FE	6	-	-	-	JM5332	6	OE 90919-02234
3.0 24V	2000.01	2004.12	143	194		6	-	-	-	JM5332	6	OE 90919-02234
3.0	2000.04	2005.06	145	197	1MZ-FE	6	-	-	-	JM5394	6	OE 90919-02214
3.5 24V	2004.09	2005.01	200	272	2GR-FE	6	-	-	-	JM5332	6	OE 90919-02234
3.5 24V	2005.02	2011.12	200	272	2GR-FE	6	-	-	-	JM5447	6	OE 90919-02251
<b>AVANZA</b>												
1.5	2006.09	2008.12	80	109	-	4	-	-	-	JM5626	4	OE 19070-B1020
<b>CAMRY</b>												
2.0 DOHC	1992.12	1995.12	-	-	5S-FE	4		X	X	JM5150	1	VIN (S)
2.2 DOHC	1992.12	1995.12	-	-	5S-FE	4		X	X	JM5150	1	VIN (S)
2.2 DOHC	1994.01	1996.12	-	-	5S-FE	4		X	X	JM5149	1	VIN (S)
2.2 DOHC	1996.01	-->	-	-	5S-FE	4		X	X	JM5149	1	VIN (G)
2.4	2006.01	2006.12	117	159	2AZ-FE	4	-	-	-	JM5144	4	Eng. (A*****-A9*****) Eng. (7*****-9*****)
2.4	2006.01	2006.12	117	159	2AZ-FE	4	-	-	-	JM5416	4	Eng. (0*****-6*****)
2.4	2006.09	2007.12	117	159	2AZ-FE	4	-	-	-	JM5144	4	Eng. (A*****-A9*****) Eng. (7*****-9*****)
2.4	2006.09	2007.12	117	159	2AZ-FE	4	-	-	-	JM5416	4	Eng. (0*****-6*****)
2.4 16V	2007.01	-->	-	-	2AZ-FE	4	-	-	-	JM5144	4	OE 90919-02251
2.4	2007.09	2009.12	118	158	2AZ-FE	4	-	-	-	JM5144	4	Eng. (A*****-A9*****) Eng. (7*****-9*****)
2.4	2007.09	2009.12	118	158	2AZ-FE	4	-	-	-	JM5416	4	Eng. (0*****-6*****)
2.4	2007.09	2010.12	140	187	2AZ-FXE	4	-	-	-	JM5144	4	Made in Japan
2.4	2007.09	2010.12	140	187	2AZ-FXE	4	-	-	-	JM5416	4	Made in USA
2.4 Hybrid	2010.09	2011.12	140	187	2AZ-FXE	4	-	-	-	JM5144	4	Made in Japan
2.4 Hybrid	2010.09	2011.12	140	187	2AZ-FXE	4	-	-	-	JM5416	4	Made in USA
2.5	1987.09	1991.12	114	155	3VZ-FE	6		X	X	JM5148	1	OE 90919-02185
2.5 V6 DOHC	1988.01	1991.12	-	-	2VZ-FE	6		X	X	JM5148	1	VIN (V)
2.5 V6 DOHC	1991.01	1992.12	-	-	-	6		X	X	JM5148	1	VIN (V)
2.5 V6 DOHC	1992.12	-->	-	-	-	6		X	X	JM5148	1	VIN (V)
3.0	1991.09	1993.12	138	188	3VZ-FE	6		X	X	JM5444	1	OE 90919-02207
3.0	1993.09	1995.12	140	190	1MZ-FE	6	-	-	-	JM5394	6	VIN (G) OE 90919-02214
3.0 24V	1994.01	1995.12	140	190	1MZ-FE	6	-	-	-	JM5394	6	OE 90919-02214
3.0	1996.01	1996.12	140	190	1MZ-FE	6		X	X	JM5427	3	VIN (F) OE 90919-02215
3.0	1996.01	1998.12	140	190	1MZ-FE	6		X	X	JM5427	3	OE 90919-02215
3.0 24V	1996.01	2001.12	140	190	1MZ-FE	6		X	X	JM5427	3	OE 90919-02215
3.0	1997.09	2001.12	140	188	1MZ-FE	6		X	X	JM5427	3	OE 90919-02215
3.0 24V	2002.01	2006.12	140	190	1MZ-FE	6	-	-	-	JM5332	6	OE 90919-02234
3.3	2003.09	2006.12	168	228	3MZ-FE	6	-	-	-	JM5433	6	OE 90919-02246
3.5	2006.09	2009.12	200	272	2GR-FE	6	-	-	-	JM5447	6	OE 90919-02251
<b>CELICA</b>												
1.8 DOHC	1996.01	1997.12	-	-	7A-FE	4		X	X	JM5150	1	VIN (B)
1.8	1999.09	2005.12	104	141	1ZZ-FE	4	-	-	-	JM5018	4	GT
1.8 GTS	1999.09	2005.12	134	182	2ZZ-GE	4	-	-	-	JM5333	4	GTS
2.0 DOHC	1992.01	1992.12	-	-	3S-GTE	4		X	X	JM5149	1	VIN (S)
2.0 DOHC	1993.01	1993.12	-	-	3S-GTE	4		X	X	JM5149	1	VIN (S)
2.2 DOHC	1990.01	1992.12	-	-	5S-FE	4		X	X	JM5149	1	VIN (S)
2.2 DOHC	1992.12	1995.12	-	-	5S-FE	4		X	X	JM5150	1	VIN (S)
2.8	1983.09	1983.12	108	147	5M-GE	6		X	X	JM5448	1	OE 90919-02106
2.8	1984.01	1985.12	108	147	5M-GE	6		X	X	JM5449	1	OE 90919-02154



TOYOTA USA												
<b>COROLLA</b>												
1.6 DOHC	1996.01	1997.12	-	-	4A-FE	4		X	X	JM5150	1	VIN (A)
1.6 DOHC	1997.01	1997.12	-	-	7A-FE	4		X	X	JM5150	1	VIN (B)
1.8	1979.09	1980.12	54	73	3T-C	4		X	X	JM5448	1	OE 90919-02106
1.8 DOHC	1995.01	1995.12	-	-	7A-FE	4		X	X	JM5150	1	VIN (A)
1.8 DOHC	1995.01	1995.12	-	-	7A-FE	4		X	X	JM5150	1	VIN (S)
1.8 DOHC	1996.01	1997.12	-	-	7A-FE	4		X	X	JM5150	1	VIN (B)
1.8	1997.09	1998.12	90	122	1ZZ-FE	4		X	X	JM5434	2	VIN (R) OE 90919-02224
1.8	1999.01	1999.12	90	122	1ZZ-FE	4	-	-	-	JM5018	4	VIN (R) OE 90919-02239
1.8	2004.09	2006.12	122	166	2ZZ-GE	4	-	-	-	JM5333	4	XRS
1.8	2006.09	2008.01	94	126	1ZZ-FE	4	-	-	-	JM5018	4	OE 90080-19015
1.8	2008.01	2009.12	94	126	1ZZ-FE	4	-	-	-	JM5144	4	Eng. (0*****-6*****) OE 90919-02244
1.8	2008.01	2009.12	94	126	1ZZ-FE	4	-	-	-	JM5416	4	Eng. (7*****-9*****) OE 90919-02248
1.8	2008.01	2009.12	94	126	1ZZ-FE	4	-	-	-	JM5416	4	Eng. (A*****-A9*****) OE 90919-02248
1.8	2008.09	2010.12	99	132	-	4	-	-	-	JM5492	4	
2.4 VVTL-i 16V	2009.01	-->	116	158	2AZ-FE	4	-	-	-	JM5144	4	
<b>CRESSIDA</b>												
2.6	1977.09	1980.12	81	110	4M	6		X	X	JM5334	1	GT40RT
2.6	1977.09	1980.12	82	112	4M	6		X	X	JM5334	1	GT40RT
2.6	1978.01	1979.12	112	152	4M	6		X	X	JM5334	1	GT40RT
2.6	1980.01	1980.12	112	152	4M	6		X	X	JM5334	1	GT40RT
2.8	1982.09	1984.12	116	158	5M-GE	6		X	X	JM5448	1	OE 90919-02106
2.8	1985.01	1988.12	116	158	5M-GE	6		X	X	JM5449	1	OE 90919-02154
3.0	1988.09	1992.12	92	125	7M-GE	6		X	X	JM5449	1	OE 90919-02154
3.0	1988.09	1992.12	142	193	7M-GE	6		X	X	JM5449	1	OE 90919-02154
<b>CROWN</b>												
2.3	1967.01	1971.12	85	116	2M	6		X	X	JM5334	1	GT40RT
<b>FJ CRUISER</b>												
4.0	2006.09	2009.12	178	242	1GR-FE	6	-	-	-	JM5416	6	OE 90919-02248
4.0 4WD	2006.09	2009.12	178	242	1GR-FE	6	-	-	-	JM5416	6	OE 90919-02248
<b>HIGHLANDER</b>												
2.4	2000.09	2005.11	116	158	2AZ-FE	4	-	-	-	JM5416	4	OE 90919-02246
2.4	2000.09	2006.12	116	158	2AZ-FE	4	-	-	-	JM5144	4	OE 90919-02244
2.4 AWD	2000.09	2005.11	116	158	2AZ-FE	4	-	-	-	JM5416	4	OE 90919-02246
2.4 16V	2001.01	2007.12	-	-	2AZ-FE	4	-	-	-	JM5144	4	
2.4 AWD	2005.12	2006.12	116	158	2AZ-FE	4	-	-	-	JM5144	4	OE 90919-02244
3.0 24V	2001.01	2003.12	164	223		6	-	-	-	JM5332	6	OE 90919-02234
3.0 24V AWD	2001.01	2003.12	164	223		6	-	-	-	JM5332	6	OE 90919-02234
3.3 24V	2003.09	2004.12	160	218	-	6	-	-	-	JM5332	6	OE 90919-02234
3.3 24V	2005.01	2006.12	160	218	3MZ-FE	6	-	-	-	JM5433	6	OE 90919-02246
3.3 AWD	2005.09	2006.12	160	218	3MZ-FE	6	-	-	-	JM5433	6	OE 90919-02246
3.3 Hibryd AWD	2007.09	2010.12	201	273	-	6	-	-	-	JM5433	6	OE 90919-02246
3.5	2007.09	2010.12	201	270	2GR-FE	6	-	-	-	JM5447	6	OE 90919-02251
3.5 AWD	2007.08	2010.12	201	273	2GR-FE	6	-	-	-	JM5447	6	OE 90919-02251
<b>HILUX</b>												
2.7	2003.09	2008.12	118	161	-	4	-	-	-	JM5416	4	OE 90919-02248
<b>LAND CRUISER</b>												
4.0 4x4	1987.09	1990.12	116	158	3F-E	6		X	X	JM5148	1	OE 90919-02185
4.0 4WD	1988.08	1992.12	116	158	3F-E	6		X	X	JM5148	1	OE 90919-02185
4.0 V8 OHV	1990.01	1992.12	-	-	3F-E	8		X	X	JM5148	2	VIN (F)
4.7 4WD	1997.09	2006.12	172	234	2UZ-FE	8	-	-	-	JM5184	8	OE 90919-02230
4.7	2006.09	2007.12	198	265	2UZ-FE	8	-	-	-	JM5184	8	OE 90919-02230
4.7 AWD	2006.09	2007.12	198	265	2UZ-FE	8	-	-	-	JM5184	8	OE 90919-02230
5.7 V8	2008.01	2009.12	-	-	3UR-FE	8	-	-	-	JM5182	8	OE 90919-02250
<b>MATRIX</b>												
1.8 16V	2003.01	2006.12	88	120	1ZZ-FE	4	-	-	-	JM5018	4	XR
1.8 16V AWD	2003.01	2006.12	88	120	1ZZ-FE	4	-	-	-	JM5018	4	XR
1.8 16V	2003.01	2006.12	122	166	2ZZ-GE	4	-	-	-	JM5333	4	XRS
1.8	2006.09	2007.12	94	126	1ZZ-FE	4	-	-	-	JM5018	4	VIN (R)
1.8	2008.01	2008.12	94	126	1ZZ-FE	4	-	-	-	JM5144	4	Eng. (0*****-6*****) VIN (R)
1.8	2008.01	2008.12	94	126	1ZZ-FE	4	-	-	-	JM5416	4	Eng. (7*****-9*****) VIN (R)



TOYOTA USA												
<b>MATRIX</b>												
1.8	2008.01	2008.12	94	126	1ZZ-FE	4	-	-	-	JM5416	4	Eng. (A*****-A9*****) VIN (R)
1.8	2008.09	2010.12	99	132	-	4	-	-	-	JM5492	4	
2.4	2008.09	2011.12	118	158	-	4	-	-	-	JM5416	4	
2.4 AWD	2008.09	2011.12	118	158	-	4	-	-	-	JM5416	4	
2.4 16V	2009.01	-->	-	-	2AZ-FE	4	-	-	-	JM5144	4	
<b>MR 2</b>												
2.0 Turbo	1990.09	1992.12	149	203	3S-GTE	4		X	X	JM5148	1	OE 90919-02185
2.0 TURBO DOHC	1991.01	1992.12	-	-	3S-GTE	4		X	X	JM5148	1	VIN (S)
2.0 TURBO DOHC	1992.12	1993.12	-	-	3S-GTE	4		X	X	JM5149	1	VIN (S)
2.2 DOHC	1991.01	1993.12	-	-	5S-FE	4		X	X	JM5149	1	VIN (S)
2.2 DOHC	1992.12	1995.12	-	-	5S-FE	4		X	X	JM5150	1	VIN (S)
<b>PASEO</b>												
1.5 DOHC	1992.12	1995.12	-	-	5S-FE	4		X	X	JM5150	1	VIN (E)
1.5	1996.09	1997.12	69	94	-	4	-/2	JP242	-	JM5181	2	
2.4	1980.09	1990.12	76	103	22R	4		X	X	JM5448	1	OE 90919-02106
2.4 4WD	1980.09	1990.12	76	103	22R	4		X	X	JM5448	1	OE 90919-02106
2.4	1984.01	1984.12	76	103	22REC	4		X	X	JM5448	1	OE 90919-02106
2.4 4WD	1984.01	1984.12	76	103	22REC	4		X	X	JM5448	1	OE 90919-02106
2.4	1984.09	1990.12	87	116	22R	4		X	X	JM5448	1	OE 90919-02106
2.4	1984.09	1984.12	87	116	22REC	4		X	X	JM5448	1	OE 90919-02106
2.4	1984.09	1990.12	101	135	22R	4		X	X	JM5448	1	OE 90919-02106
2.4	1984.09	1984.12	101	135	22REC	4		X	X	JM5448	1	OE 90919-02106
2.4 SOHC	1993.01	1995.12	-	-	3VZ-E	4		X	X	JM5149	1	VIN (R)
3.0 V6 SOHC	1988.01	1991.12	-	-	3VZ-E	6		X	X	JM5148	1	VIN (V)
3.0	1989.01	1993.12	112	152	3VZ-E	6		X	X	JM5148	1	OE 90919-02185
3.0 4WD	1989.01	1995.12	112	152	3VZ-E	6		X	X	JM5148	1	OE 90919-02185
3.0 V6 SOHC	1992.12	1995.12	-	-	3VZ-E	6		X	X	JM5149	1	VIN (V)
<b>RAV4</b>												
2.0 DOHC	1996.01	1996.12	-	-	3S-FE	4		X	X	JM5150	1	VIN (P)
2.4 16V	2006.01	2008.12	-	-	2AZ-FE	4	-	-	-	JM5144	4	
3.5	2005.09	2010.12	201	273	2GR-FE	6	-	-	-	JM5447	6	OE 90919-02251
3.5 4WD	2005.09	2010.12	201	273	2GR-FE	6	-	-	-	JM5447	6	OE 90919-02251
<b>SEQUOIA</b>												
4.7	2000.09	2003.12	150	204	2UZ-FE	8	-	-	-	JM5184	8	OE 90919-02230
4.7	2000.09	2006.12	179	243	2UZ-FE	8	-	-	-	JM5184	8	OE 90919-02230
4.7 4WD	2003.09	2006.12	179	243	2UZ-FE	8	-	-	-	JM5184	8	OE 90919-02230
4.7	2006.09	2009.12	206	276	2UZ-FE	8	-	-	-	JM5184	8	OE 90919-02230
4.7 4WD	2006.09	2009.12	206	276	2UZ-FE	8	-	-	-	JM5184	8	OE 90919-02230
5.7	2006.09	2009.12	284	381	3UR-FE	8	-	-	-	JM5182	8	OE 90919-02250
5.7 4WD	2007.09	2009.12	284	381	3UR-FE	8	-	-	-	JM5182	8	OE 90919-02250
5.7 FLEX	2007.09	2009.12	284	381	3UR-FE	8	-	-	-	JM5182	8	OE 90919-02250
5.7 FLEX 4WD	2008.09	2009.12	284	381	3UR-FE	8	-	-	-	JM5182	8	OE 90919-02250
5.7	2009.01	2009.12	284	381	3UR-FBE	8	-	-	-	JM5182	8	OE 90919-02250
5.7 4WD	2009.01	2009.12	284	381	3UR-FBE	8	-	-	-	JM5182	8	OE 90919-02250
5.7 FLEX	2009.01	2009.12	284	381	3UR-FBE	8	-	-	-	JM5182	8	OE 90919-02250
5.7 FLEX 4WD	2009.01	2009.12	284	381	3UR-FBE	8	-	-	-	JM5182	8	OE 90919-02250
<b>SIENNA</b>												
3.0	1997.09	2000.12	145	197	1MZ-FE	6		X	X	JM5427	3	OE 90919-02215
3.0	2001.01	2003.12	145	197	1MZ-FE	6	-	-	-	JM5332	6	OE 90919-02234
3.0 24V	2001.01	2003.12	145	197	1MZ-FE	6	-	-	-	JM5332	6	OE 90919-02234
3.5	2006.09	2011.12	198	265	2GR-FE	6	-	-	-	JM5447	6	OE 90919-02251
3.5 AWD	2009.09	2011.12	199	266	2GR-FE	6	-	-	-	JM5447	6	OE 90919-02251
<b>SOLARA</b>												
2.4	2001.09	2008.12	117	159	2AZ-FE	4	-	-	-	JM5144	4	OE 90919-02244
2.4 16V	2002.01	2007.12	-	-	2AZ-FE	4	-	-	-	JM5144	4	
2.4	2006.06	2008.12	117	159	2AZ-FE	4	-	-	-	JM5416	4	OE 90919-02248
3.0	1998.09	2003.12	148	201	1MZ-FE	6		X	X	JM5427	3	OE 90919-02215
<b>SUPRA</b>												
3.0 Turbo	1987.01	1992.12	149	203	-	6	-/6	JP134	JPE134	X	1	coil set OE 19080-42020
3.0 Turbo	1987.01	1992.12	149	203	-	6	-/6	JP134	JPE134	X	3	single coil OE 90919-02174
3.0 Twin Turbo	1992.09	1993.12	164	223	2JZ-GTE	6	-/6	JP134	JPE134	X	1	coil set
3.0 Twin Turbo	1992.09	1993.12	164	223	2JZ-GTE	6	-/6	JP134	JPE134	X	3	single coil
3.0 Twin Turbo	1994.01	1995.12	164	223	2JZ-GTE	6	-	-	-	JM5395	6	VIN (J)
3.0 Twin Turbo	1996.01	1998.12	164	223	2JZ-GTE	6	-	-	-	JM5395	6	VIN (E)



## TOYOTA USA

TOYOTA USA												
<b>T100</b>												
2.7 DOHC	1994.01	1995.12	-	-	3RZ-FE	4		X	X	JM5150	1	VIN (U)
2.7 DOHC	1996.01	1997.12	-	-	3RZ-FE	4		X	X	JM5150	1	VIN (M)
2.7	1998.01	1998.12	112	152	3RZ-FE	4		X	X	JM5393	1	1 & 4 cyl.; VIN (M)
2.7	1998.01	1998.12	112	152	3RZ-FE	4		X	X	JM5412	1	2 & 3 cyl.; VIN (M)
3.0 V6 SOHC	1993.01	1994.12	-	-	3VZ-E	6		X	X	JM5149	1	VIN (V)
3.4	1994.09	1998.12	142	193	5VZ-FE	6		X	X	JM5143	3	OE 90919-02212
3.4 4WD	1994.09	1998.12	142	193	5VZ-FE	6		X	X	JM5143	3	OE 90919-02212
<b>TACOMA</b>												
2.4 DOHC	1995.01	1995.12	-	-	2RZ-FE	4		X	X	JM5150	1	VIN (U)
2.4 DOHC	1996.01	1997.12	-	-	2RZ-FE	4		X	X	JM5150	1	VIN (L)
2.7 DOHC	1995.01	1995.12	-	-	3RZ-FE	4		X	X	JM5150	1	VIN (U)
2.7 DOHC	1996.01	1997.12	-	-	3RZ-FE	4		X	X	JM5150	1	VIN (M)
2.7	1997.01	2000.12	112	150	3RZ-FE	4		X	X	JM5393	1	1 & 4 cyl.; VIN (M)
2.7	1997.01	2000.12	112	150	3RZ-FE	4		X	X	JM5412	1	2 & 3 cyl.; VIN (M)
2.7 AWD	1997.01	2000.12	112	150	3RZ-FE	4		X	X	JM5393	1	1 & 4 cyl.; VIN (M)
2.7 AWD	1997.01	2000.12	112	150	3RZ-FE	4		X	X	JM5412	1	2 & 3 cyl.; VIN (M)
2.7 L4	2005.01	2010.12	-	-	2TR-FE	4	-	-	-	JM5416	4	OE 90919-02248
2.7	2006.09	2010.12	119	159	2TR-FE	4	-	-	-	JM5416	4	OE 90919-02248
2.7 4WD	2006.09	2010.12	119	159	2TR-FE	4	-	-	-	JM5416	4	OE 90919-02248
3.4	1994.09	2000.12	142	190	5VZ-FE	6		X	X	JM5143	3	OE 90919-02212
3.4 4WD	1994.09	2000.12	142	190	5VZ-FE	6		X	X	JM5143	3	OE 90919-02212
3.4	2000.09	2004.12	142	193	5VZ-FE	6		X	X	JM5143	3	OE 90919-02212
3.4 4WD	2003.09	2004.12	142	193	5VZ-FE	6		X	X	JM5143	3	OE 90919-02212
4.0 V6	2005.01	2010.12	-	-	1GR-FE	6	-	-	-	JM5416	6	OE 90919-02248
4.0	2005.09	2006.12	176	239	1GR-FE	6	-	-	-	JM5416	6	OE 90919-02248
4.0 4WD	2005.09	2006.12	176	239	1GR-FE	6	-	-	-	JM5416	6	OE 90919-02248
<b>TERCEL</b>												
1.5	1979.09	1980.12	46	63	1AC	4		X	X	JM5448	1	OE 90919-02106
1.5 SOHC	1987.01	1988.12	-	-	3AC	4		X	X	JM5150	1	VIN (A)
1.5 SOHC	1987.01	1991.12	-	-	3E	4		X	X	JM5150	1	VIN (E)
1.5 SOHC	1990.01	1994.12	-	-	3E-E	4		X	X	JM5150	1	VIN (E)
1.5	1995.09	1998.12	69	94	-	4	-/2	JP242	-	JM5181	2	
1.5 SOHC	1998.01	1998.12	-	-	3E	4		X	X	JM5150	1	VIN (E)
<b>TUNDRA</b>												
3.4	1999.09	2004.12	142	193	5VZ-FE	6		X	X	JM5143	3	OE 90919-02212
3.4 4WD	1999.09	2004.12	142	193	5VZ-FE	6		X	X	JM5143	3	OE 90919-02212
4.0 V6	2005.01	2009.12	-	-	1GR-FE	6	-	-	-	JM5416	6	OE 90919-02248
4.0	2005.09	2009.12	176	239	1GR-FE	6	-	-	-	JM5416	6	OE 90919-02248
4.0 4WD	2005.09	2009.12	176	239	1GR-FE	6	-	-	-	JM5416	6	OE 90919-02248
4.7	1999.09	2003.12	183	245	2UZ-FE	8	-	-	-	JM5184	8	OE 90919-02230
4.7 4WD	1999.09	2003.12	183	245	2UZ-FE	8	-	-	-	JM5184	8	OE 90919-02230
4.7	2003.09	2006.12	179	243	2UZ-FE	8	-	-	-	JM5184	8	OE 90919-02230
4.7 4WD	2003.09	2006.12	179	243	2UZ-FE	8	-	-	-	JM5184	8	OE 90919-02230
4.7	2006.09	2009.12	206	276	2UZ-FE	8	-	-	-	JM5184	8	OE 90919-02230
5.7	2009.01	2009.12	284	381	3UR-FE	8	-	-	-	JM5182	8	OE 90919-02250
5.7 4WD	2009.01	2009.12	284	381	3UR-FE	8	-	-	-	JM5182	8	OE 90919-02250
5.7 Flexfuel	2009.01	2009.12	284	381	3UR-FE	8	-	-	-	JM5182	8	OE 90919-02250
5.7 Flexfuel 4WD	2009.01	2009.12	284	381	3UR-FE	8	-	-	-	JM5182	8	OE 90919-02250
<b>VENZA</b>												
3.5	2008.09	2010.12	200	272	2GR-FE	6	-	-	-	JM5447	6	OE 90919-02251
3.5 AWD	2008.09	2010.12	200	272	2GR-FE	6	-	-	-	JM5447	6	OE 90919-02251

## TRIUMPH USA

TRIUMPH USA												
<b>HERALD</b>												
0.9	1960.01	1961.12	-	-	-	4		X	X	JM5455	1	+ resistor
<b>SPITFIRE</b>												
1.2	1962.09	1967.12	47	63	-	4		X	X	JM5455	1	+ resistor
1.3	1967.09	1972.12	36	48	-	4		X	X	JM5455	1	+ resistor
1.5	1972.09	1974.12	43	58	-	4		X	X	JM5455	1	+ resistor
<b>STAG</b>												
3.0	1970.01	1973.12	107	145	LE	8		X	X	JM5334	1	GT40RT
<b>TR4A</b>												
2.1	1964.09	1967.12	78	105	-	4		X	X	JM5455	1	+ resistor
<b>TR6</b>												
2.5	1969.01	1974.12	105	143	-	6		X	X	JM5335	1	for BOSCH GT40T R1=3.0[Ω], R2=8.5[kΩ]





TRIUMPH USA										
<b>TR6</b>										
2.5	1969.01	1972.12	-	-	-	6	X	X	JM5455	1 + resistor
2.5	1975.01	1976.12	105	143	-	6	X	X	JM5335	1 for BOSCH GT40T R1=3.0[Ω], R2=8.5[kΩ]
<b>TR7</b>										
2.0 8V	1975.01	1976.12	-	-	CG	4	X	X	JM5334	1 GT40RT
2.0 8V	1978.01	1979.12	-	-	CV	4	X	X	JM5334	1 GT40RT
2.0 8V	1978.01	1979.12	-	-	CV	4	X	X	JM5334	1 GT40RT, carb.
2.0 8V	1978.01	1979.12	-	-	CK	4	X	X	JM5334	1 GT40RT, FI
2.0	1980.01	1981.12	95	127	-	4	X	X	JM5355	1
2.0	1980.01	1981.12	95	127	-	4	X	X	JM5355	1
<b>TR8</b>										
3.5	1979.09	1981.12	110	150	-	4	X	X	JM5355	1
<b>TR250</b>										
2.5	1968.01	1968.12	83	111	-	6	X	X	JM5455	1 + resistor
2.5	1968.01	1968.12	83	111	-	6	X	X	JM5335	1 for BOSCH GT40T R1=3.0[Ω], R2=8.5[kΩ]
VOLVO USA										
<b>145</b>										
1.8	1968.01	1968.12	-	-	B 18	4	X	X	JM5335	1 for BOSCH GT40T R1=3.0[Ω], R2=8.5[kΩ]
2.0	1969.01	1971.12	-	-	B 20 E	4	X	X	JM5335	1 for BOSCH GT40T R1=3.0[Ω], R2=8.5[kΩ]
2.0	1972.01	1974.12	-	-	B 20 E	4	X	X	JM5335	1 for BOSCH GT40T R1=3.0[Ω], R2=8.5[kΩ]
<b>164</b>										
3.0	1970.01	1971.12	-	-	B 30 E	6	X	X	JM5335	1 for BOSCH GT40T R1=3.0[Ω], R2=8.5[kΩ]
3.0	1972.01	1974.12	-	-	B 30 E	6	X	X	JM5335	1 for BOSCH GT40T R1=3.0[Ω], R2=8.5[kΩ]
3.0	1972.01	1972.12	117	160	B 30 F	6	X	X	JM5334	1 GT40RT
3.0	1973.01	1974.12	101	138	B 30 F	6	X	X	JM5334	1 GT40RT
3.0 E	1974.01	1974.12	108	145	-	6	X	X	JM5355	1 Carb.
3.0	1974.09	1975.12	106	144	B 30 E	6	X	X	JM5355	1
3.0	1975.01	1975.12	-	-	B 30 F	6	X	X	JM5334	1 GT40RT Federal130[KM] California 125[KM]
<b>240</b>										
2.0 (244, 245)	1974.09	1975.12	60	82	B 20 E	4	X	X	JM5355	1
2.1 (242, 244, 245)	1980.01	1981.12	80	107	B 21 FT	4	X	X	JM5355	1 VIN (4) Clip on Dist. Cap
2.1 (242, 244, 245)	1980.01	1981.12	80	107	B 21 FT	4	X	X	X	1 VIN (4) Bolt on Dist. Cap
2.1 (242, 244, 245)	1980.01	1982.12	91	124	B 21 FT	4	X	X	JM5355	1 VIN (4) Clip on Dist. Cap
2.1 (242, 244, 245)	1980.01	1982.12	91	124	B 21 FT	4	X	X	X	1 VIN (4) Bolt on Dist. Cap
2.1 (242, 244, 245)	1982.01	1982.12	91	124	B 21 F	4	X	X	JM5355	1 VIN (4) Clip on Dist. Cap
2.1 (242, 244, 245)	1982.01	1982.12	91	124	B 21 F	4	X	X	X	1 VIN (4) Bolt on Dist. Cap
2.1 (242, 244, 245)	1984.01	1984.12	91	124	B 21 FT	4	X	X	JM5355	1 VIN (4)
2.1 (242, 244, 245)	1984.01	1984.12	115	157	B 21 FT	4	X	X	JM5355	1 VIN (4)
2.3 (242, 244, 245)	1980.09	1981.12	83	111	-	4	X	X	JM5355	1 Clip on Dist. Cap
2.3 (242, 244, 245)	1980.09	1981.12	83	111	-	4	X	X	X	1 Bolt on Dist. Cap
2.3 (242, 244, 245)	1981.09	1982.12	84	114	-	4	X	X	JM5355	1 Clip on Dist. Cap
2.3 (242, 244, 245)	1981.09	1982.12	84	114	-	4	X	X	X	1 Bolt on Dist. Cap
<b>260</b>										
2.7 (262)	1978.01	1979.12	93	127	B 27 F	6	X	X	JM5355	1 VIN (65)
2.7 (264, 265)	1978.01	1979.12	93	127	B 27 F	6	X	X	JM5355	1 VIN (61), VIN (65)
2.8 (262, 264, 265)	1979.09	1981.12	114	155	B 28 F	6	X	X	JM5355	1 VIN (6)
<b>444</b>										
1.4	1950.01	1958.12	-	-	-	4	X	X	JM5335	1 for BOSCH GT40T R1=3.0[Ω], R2=8.5[kΩ]
<b>445</b>										
1.4	1956.01	1959.12	-	-	-	4	X	X	JM5335	1 for BOSCH GT40T R1=3.0[Ω], R2=8.5[kΩ]
1.6	1959.01	1960.12	-	-	-	4	X	X	JM5335	1 for BOSCH GT40T R1=3.0[Ω], R2=8.5[kΩ]
<b>544</b>										
1.8	1962.01	1966.12	-	-	-	4	X	X	JM5335	1 for BOSCH GT40T R1=3.0[Ω], R2=8.5[kΩ]



## VOLVO USA

<b>760</b>											
2.8	1982.09	1986.12	108	147	B 28 F	6		X	X	JM5355	1
2.8	1982.09	1986.12	108	147	B 28 F	6		X	X	JM5355	1
<b>1800</b>											
1.8	1961.01	1968.12	-	-	-	4		X	X	JM5335	1 for BOSCH GT40T R1=3.0[Ω], R2=8.5[kΩ]
1.8	1967.01	1968.12	-	-	-	4		X	X	JM5335	1 for BOSCH GT40T R1=3.0[Ω], R2=8.5[kΩ]
2.0	1969.01	1969.12	-	-	B 20 E	4		X	X	JM5335	1 for BOSCH GT40T R1=3.0[Ω], R2=8.5[kΩ]
2.0	1970.01	1973.12	-	-	B 20 E	4		X	X	JM5335	1 for BOSCH GT40T R1=3.0[Ω], R2=8.5[kΩ]
<b>C30</b>											
2.4 i	2007.09	2010.12	125	168	B 5244 S4	5	-	-	-	JM5409	5
2.5 T5	2007.09	2011.12	162	218	B 5254 T7	5	-	-	-	JM5409	5
<b>C70</b>											
2.3	1998.09	2004.12	176	239	B 5234 T3	5	-	-	-	JM5057	5 VIN (53); OE 9125601
2.3	1998.09	2002.12	176	236	B 5234 T3	5	-	-	-	JM5057	5 OE 9125601
2.3	1999.01	2002.12	176	236	B 5234 T3	5	-	-	-	JM5057	5 OE 9125601
2.3	2003.01	2004.12	176	236	B 5234 T9	5	-	-	-	JM5057	5 OE 9125601
2.4	1998.09	2003.12	142	193	B 5254 T	5	-	-	-	JM5057	5 OE 9125601
2.4	2003.01	2003.12	142	193	B 5244 T7	5	-	-	-	JM5057	5 OE 9125601
2.4	2003.09	2004.12	180	242	-	5	-	-	-	JM5057	5 OE 9125601; black
2.4	2004.09	2005.12	191	257	-	5	-	-	-	JM5057	5 OE 9125601; black
2.5 T5	2005.09	2007.12	162	218	B 5254 T3	5	-	-	-	JM5409	5
2.5 T5	2007.09	2007.12	169	227	B 5254 T3	5	-	-	-	JM5409	5
2.5 T5	2008.01	2011.12	162	218	B 5254 T7	5	-	-	-	JM5409	5
2.5 T5	2008.01	2010.12	169	227	B 5254 T7	5	-	-	-	JM5409	5
<b>DL</b>											
2.1	1983.09	1984.12	72	98	B 21 A	4		X	X	JM5355	1
<b>GLE</b>											
2.3	1983.09	1984.12	96	131	B 23 F-LH	4		X	X	JM5355	1
<b>S40</b>											
2.4	2003.09	2006.12	125	168	B 5244 S7	5	-	-	-	JM5409	5 OE 8677837; grey
2.4	2007.01	2010.12	-	-	B 5244 S4	5	-	-	-	JM5409	5 OE 8677837; grey
2.5	2003.09	2006.12	162	218	B 5254 T3	5	-	-	-	JM5409	5 OE 8677837; grey
2.5	2007.01	2007.12	-	-	B 5254 T3	5	-	-	-	JM5409	5 OE 8677837
2.5	2008.01	2011.12	-	-	B 5254 T7	5	-	-	-	JM5409	5 OE 8677837
<b>S60</b>											
2.3 T5	2000.09	2004.12	176	236	B 5234 T3	5	-	-	-	JM5057	5 VIN (53); OE 9125601
2.3 T5	2005.01	2005.12	-	-	B 5234 T3	5	-	-	-	JM5057	5 OE 9125601
2.4	2000.09	2003.12	125	170	B 5244 S	5	-	-	-	JM5057	5 OE 9125601
2.4	2000.09	2005.12	125	170	B 5234 S	5	-	-	-	JM5057	5 OE 9125601
2.4 AWD	2001.09	2002.12	147	197	B 5234 T3	5	-	-	-	JM5057	5 OE 9125601; black
2.4 AWD	2001.09	2002.12	147	197	B 5244 S	5	-	-	-	JM5057	5 OE 9125601; black
2.4	2003.01	2003.12	125	170	B 5234 S6	5	-	-	-	JM5057	5 OE 9125601
2.4 T5	2005.09	2006.12	191	257	-	5	-	-	-	JM5057	5 OE 9125601; black
2.4	2006.01	2007.12	-	-	B 5244 T5	5	-	-	-	JM5057	5 OE 9125601
2.5	2002.09	2003.12	103	140	-	5	-	-	-	JM5057	5 OE 9125601; black
2.5 AWD	2002.09	2003.12	155	208	-	5	-	-	-	JM5057	5 OE 9125601; black
2.5	2003.09	2006.12	155	208	B 5254 T2	5	-	-	-	JM5409	5 OE 8677837; grey
2.5 AWD	2003.09	2006.12	224	300	B 5254 T2	5	-	-	-	JM5409	5 OE 8677837; grey
2.5	2007.01	2009.12	-	-	B 5254 T2	5	-	-	-	JM5409	5 OE 8677837
2.5 AWD	2007.01	2007.12	-	-	B 5254 T4	5	-	-	-	JM5409	5 OE 8677837
2.5	2008.01	2009.12	-	-	B 5244 T5	5	-	-	-	JM5409	5 OE 8677837
2.5 AWD	2008.01	2009.12	-	-	B 5244 T5	5	-	-	-	JM5409	5 OE 8677837
2.5 T5	2011.09	-->	186	250	B 5254 T5	5	-	-	-	JM5409	5 OE 8677837; grey
3.0 T6 AWD	2010.09	-->	224	300	B 5254 T5	6	-	-	-	JM5409	6 OE 8677837; grey
<b>S70</b>											
2.3 T5	1997.09	1998.12	176	236	B 5234 T3	5		X	X	JM5056	1 OE 1275174
2.3 T5	1999.01	2000.12	176	236	B 5234 T3	5	-	-	-	JM5057	5 OE 9125601
2.4	1997.09	1998.12	125	170	B 5254 S	5		X	X	JM5056	1 OE 1275174
2.4 AWD	1998.09	1998.12	142	190	B 5254 T	5		X	X	JM5056	1 OE 1275174
2.4	1999.01	2000.12	125	170	B 5254 T	5	-	-	-	JM5057	5 OE 9125601
2.4 AWD	1999.01	1999.12	142	190	B 5254 S	5	-	-	-	JM5057	5 OE 9125601
2.4 AWD	2000.01	2000.12	142	190	B 5244 S	5	-	-	-	JM5057	5 OE 9125601
2.4 AWD	2000.01	2000.12	142	190	B 5244 S	5		X	X	JM5056	1 OE 1275174



## VOLVO USA

VOLVO USA												
<b>S80</b>												
2.5	2004.09	2006.12	155	208	B 5254 T2	5	-	-	-	JM5057	5	OE 9125601; black
2.5 AWD	2004.09	2006.12	155	208	B 5254 T2	5	-	-	-	JM5057	5	OE 9125601; black
2.8 T6	1998.09	2001.12	200	268	B 6284 T	6	-	-	-	JM5057	6	OE 9125601; black
2.8 T6	2001.01	2003.12	-	-	-	6	-	-	-	JM5057	6	OE 9125601; black
2.9	1998.09	2005.12	147	197	B 6304 S	6	-	-	-	JM5057	6	OE 9125601
2.9	2003.01	2005.12	147	197	B 6294 T	6	-	-	-	JM5057	6	OE 9125601
2.9	2004.01	2006.12	-	-	-	6	-	-	-	JM5057	6	OE 9125601; black
<b>V50</b>												
2.4	2007.01	2010.12	125	168	B 5244 S	5	-	-	-	JM5057	5	OE 9125601
2.5 T5	2004.09	2006.12	162	220	B 5254 T3	5	-	-	-	JM5409	5	OE 8677837
2.5 T5 AWD	2004.09	2006.12	162	220	B 5254 T3	5	-	-	-	JM5409	5	OE 8677837
2.5 T5	2007.01	2007.12	162	220	B 5254 T2	5	-	-	-	JM5409	5	OE 8677837
2.5 T5 AWD	2007.01	2007.12	162	220	B 5254 T2	5	-	-	-	JM5409	5	OE 8677837
2.5	2007.09	2011.12	162	220	B 5254 T7	5	-	-	-	JM5409	5	OE 8677837; grey
2.5 T5	2008.01	2008.12	162	220	B 5254 T7	5	-	-	-	JM5409	5	OE 8677837
2.5 T5 AWD	2008.01	2008.12	162	220	B 5254 T7	5	-	-	-	JM5409	5	OE 8677837
2.5 AWD	2008.09	2010.12	162	220	B 5254 T7	5	-	-	-	JM5409	5	OE 8677837; grey
<b>V70</b>												
2.3 AWD	1997.09	1998.12	176	236	B 5234 T3	5	-	X	X	JM5056	1	OE 1275174
2.3	1998.09	2004.12	176	236	B 5234 T8	5	-	-	-	JM5057	5	VIN (62); OE 9125601
2.3	1998.09	2004.12	176	236	B 5234 T3	5	-	-	-	JM5057	5	VIN (53); OE 9125601
2.3 AWD	1999.01	2000.12	176	236	B 5234 T8	5	-	-	-	JM5057	5	OE 9125601
2.4	1997.09	1998.12	125	170	B 5234 T3	5	-	X	X	JM5056	1	OE 1275174
2.4 AWD	1997.09	2002.12	142	193	-	5	-	-	-	JM5057	5	OE 9125601
2.4 AWD	1997.09	2002.12	142	193	-	5	-	X	X	JM5056	1	OE 1275174
2.4	1999.01	2006.12	125	170	B 5234 T3	5	-	-	-	JM5057	5	OE 9125601
2.4	2004.09	2005.12	220	299	-	5	-	-	-	JM5057	5	Denso fuel system OE 9125601; black
2.4	2004.09	2005.12	220	299	-	5	-	-	-	JM5409	5	Bosch fuel system OE 8677837; grey
2.4	2006.09	2007.12	125	170	B 5244 S	5	-	-	-	JM5057	5	OE 9125601; black
2.5	2002.09	2003.12	103	140	-	5	-	-	-	JM5057	5	OE 9125601; black
2.5 AWD	2002.09	2003.12	155	208	-	5	-	-	-	JM5057	5	OE 9125601; black
2.5	2005.01	2005.12	155	208	B 5244 T5	5	-	-	-	JM5057	5	OE 9125601
2.5 AWD	2005.01	2005.12	155	208	B 5244 T5	5	-	-	-	JM5057	5	OE 9125601
2.5	2006.09	2007.12	155	208	B 5254 T2	5	-	-	-	JM5057	5	OE 9125601; black
2.5	2006.09	2007.12	155	208	B 5254 T4	5	-	-	-	JM5409	5	OE 8677837; grey
2.5 AWD	2006.09	2007.12	155	208	B 5254 T2	5	-	-	-	JM5057	5	OE 9125601; black
2.5 AWD	2006.09	2007.12	155	208	B 5254 T4	5	-	-	-	JM5409	5	OE 8677837; grey
<b>XC70</b>												
2.5 AWD	2002.09	2004.12	155	208	B 5254 T2	5	-	-	-	JM5057	5	OE 9125601; black
2.5 AWD	2004.09	2006.12	155	208	B 5254 T2	5	-	-	-	JM5057	5	OE 9125601; black
2.5 AWD	2006.09	2007.12	155	208	B 5254 T2	5	-	-	-	JM5057	5	OE 9125601; black
2.5 AWD	2007.01	2007.12	155	208	B 5254 T2	5	-	-	-	JM5057	5	OE 9125601; black
<b>XC90</b>												
2.5 T	2003.01	2006.12	155	208	B 5254 T2	5	-	-	-	JM5057	5	OE 9125601; black
2.5 T AWD	2003.01	2006.12	155	208	B 5254 T2	5	-	-	-	JM5057	5	OE 9125601; black
2.9 T6 AWD	2003.01	2005.12	200	268	B 6294 T	6	-	-	-	JM5057	6	OE 9125601; black

## VOLKSWAGEN USA (VW)

VOLKSWAGEN USA (VW)												
<b>BEETLE</b>												
1.1	1951.01	1951.12	-	-	-	4	-	X	X	JM5335	1	for BOSCH GT40T R1=3.0[Ω] R2=8.5[kΩ] U=12[V]
1.2	1953.09	1966.12	27	37	-	4	-	X	X	JM5335	1	for BOSCH GT40T R1=3.0[Ω], R2=8.5[kΩ] Dist. Bosch 0231137009 OE 113905205K
1.5	1966.09	1969.12	40	54	-	4	-	X	X	JM5335	1	for BOSCH GT40T R1=3.0[Ω], R2=8.5[kΩ] Dist. BO- SCH 0231137009 OE 113905205K
1.6	1970.01	1974.12	37	50	AD	4	-	X	X	JM5335	1	for BOSCH GT40T R1=3.0[Ω], R2=8.5[kΩ]



## VOLKSWAGEN USA (VW)

CABRIO												
2.0	1995.01	2002.12	86	115	ABA	4		X	X	JM5046	1	VIN (A), VIN (B), VIN (C)
2.0	1995.01	2002.12	-	-	ABA	4		X	X	JM5494	1	- module
2.0	1995.01	2002.12	-	-	ABA	4		X	X	JM5045	1	+ module
CABRIOLET												
1.8 8V	1991.01	1993.12	70	94	2H	4		X	X	JM5046	1	VIN (B), VIN (C)
CAMPMOBILE												
1.6	1968.01	1971.12	-	-	B, C	4		X	X	JM5335	1	for BOSCH GT40T R1=3.0[Ω], R2=8.5[kΩ]
1.7	1972.01	1973.12	-	-	CA, CB, CD, CE	4		X	X	JM5335	1	for BOSCH GT40T R1=3.0[Ω], R2=8.5[kΩ]
1.8	1974.01	1974.12	-	-	AP, AW, ED	4		X	X	JM5335	1	for BOSCH GT40T R1=3.0[Ω], R2=8.5[kΩ]
CC												
3.6 VR6	2009.01	2010.12	209	280	BLV	6	-	-	-	JM5360	6	FSI-Motor OE 022905715A
3.6 VR6 4Motion 4x4	2009.01	2010.12	209	280	BLV	6	-	-	-	JM5360	6	FSI-Motor OE 022905715A
COMBI												
1.8	1995.01	2001.12	-	-	-	4		X	X	JM5046	1	Mexico
DASHER												
1.5	1974.09	1974.12	52	70	XV	4		X	X	JM5355	1	
1.5	1975.01	1975.12	52	70	XR, XS	4		X	X	JM5355	1	
1.6	1975.07	1976.12	57	76	YK	4		X	X	JM5355	1	
1.6	1975.07	1980.12	57	76	YG, YH	4		X	X	JM5355	1	
1.6	1980.01	1980.12	57	76	YH	4		X	X	JM5355	1	Exc. California
DERBY												
1.8	1995.01	2000.12	-	-	-	4		X	X	JM5046	1	Mexico
1.8	2008.01	2009.12	-	-	-	4		X	X	JM5046	1	Mexico
EOS												
3.2 V6 DOHC 195 cid.	2007.01	-->	-	-	BUB	6		X	X	JM5066	6	
3.2 FSI	2008.01	2008.12	-	-	CBRA	6	-	-	-	JM5360	6	OE 022905715A
EUROVAN												
2.5	1992.01	1994.12	80	108	AAF	5		X	X	JM5046	1	VIN (D), VIN (C)
2.5	1995.01	1995.12	-	-	ACU	5		X	X	JM5046	1	VIN (D), VIN (C)
2.5	1996.01	1996.12	-	-	ACU	5		X	X	JM5046	1	VIN (E)
2.5	2001.01	2003.12	-	-	-	5		X	X	JM5046	1	Mexico
2.5	2004.01	2004.12	-	-	-	5		X	X	JM5046	1	Mexico VIN (704000001- 704099000)
FASTBACK												
1.6	1966.01	1967.12	-	-	P, T	4		X	X	JM5335	1	for BOSCH GT40T R1=3.0[Ω], R2=8.5[kΩ]
1.6	1968.01	1973.12	-	-	P, T, U	4		X	X	JM5335	1	for BOSCH GT40T R1=3.0[Ω], R2=8.5[kΩ]
FOX												
1.8	1990.10	1993.12	60	81	ABG	4		X	X	JM5046	1	VIN (A), VIN (B)
GOLF												
1.8 8V	1991.01	1992.12	63	86	PF, RV	4		X	X	JM5046	1	VIN (A), VIN (B), VIN (K)
1.8 8V	1991.01	1992.12	75	100	PF, RV	4		X	X	JM5046	1	VIN (A), VIN (B), VIN (K)
1.8	1993.01	1996.12	-	-	ACC	4		X	X	JM5046	1	VIN (N)
1.8	1996.01	1997.12	-	-	-	4		X	X	JM5046	1	VIN (B)
1.8	1998.01	1998.12	-	-	ACC	4		X	X	JM5046	1	Canada
2.0 16V GTI	1990.01	2007.12	87	117	-	4		X	X	JM5046	1	Mexico
2.0 8V	1993.01	1998.12	86	115	ABA	4		X	X	JM5046	1	VIN (A), VIN (B), VIN (C), VIN (L), VIN (R)
GOLF R32												
3.2 V6 DOHC 195 cid.	2004.01	2005.12	177	241	BJS	6		-	-	JM5066	6	
GOLF WOLFSBURG EDITION												
2.0	1999.01	1999.12	86	115	ABA	4		X	X	JM5494	1	- module
2.0	1999.01	1999.12	86	115	ABA	4		X	X	JM5045	1	+ module
JETTA												
1.6	1979.09	1980.12	56	76	YH	4		X	X	JM5355	1	Exc. California
1.8	1991.01	1992.12	75	100	PF, RV	4		X	X	JM5046	1	VIN (A), VIN (B), VIN (K)
1.8	1993.01	1995.12	67	90	ACC	4		X	X	JM5046	1	VIN (N)
2.0	1993.01	1998.12	86	115	ABA	4		X	X	JM5046	1	VIN (A), VIN (B), VIGN (C), VIN (L)



VOLKSWAGEN USA (VW)												
<b>KARMANN GHIA</b>												
1.2	1954.01	1966.12	-	-	-	4		X	X	JM5335	1	for BOSCH GT40T R1=3.0[Q], R2=8.5[kQ] Dist. ZV/JU4R3, Bosch 0231137005, 0231147002 OE 111905205N
1.3	1966.01	1966.12	-	-	-	4		X	X	JM5335	1	for BOSCH GT40T R1=3.0[Q], R2=8.5[kQ] Dist. Bosch 0231137009 OE 113905205K
1.5	1966.01	1966.12	-	-	-	4		X	X	JM5335	1	for BOSCH GT40T R1=3.0[Q], R2=8.5[kQ] Dist. Bosch 0231137009 OE 113905205K
1.5	1968.01	1969.12	-	-	-	4		X	X	JM5335	1	for BOSCH GT40T R1=3.0[Q], R2=8.5[kQ] Dist. Bosch 0231137009 OE 113905205K
<b>PANEL</b>												
1.8	1995.01	2001.12	-	-	-	4		X	X	JM5046	1	Mexico
<b>PASSAT</b>												
2.0 8V	1995.01	1996.12	86	115	ABA	4		X	X	JM5046	1	VIN (C)
2.8 12V	1993.01	1997.12	128	172	-	6		X	X	JM5046	1	Mexico
3.6 V6 FSI	2008.01	2010.12	209	280	BLV	6	-	-	-	JM5360	6	OE 022905715A
3.6 V6 DOHC 219 cid. VR6	2006.01	-->	-	-	BLV	6		X	X	JM5066	6	
3.6 V6 FSI	2008.01	2008.12	-	-	BLV	6		X	X	JM5360	6	OE 022905715A
<b>RABBIT</b>												
1.5	1974.09	1975.12	51	70	FC, FG	4		X	X	JM5355	1	
1.5	1977.09	1980.12	46	62	EH	4		X	X	JM5355	1	Dist. 0231176057 049905705A
1.5	1977.09	1980.12	46	62	FX	4		X	X	JM5355	1	
1.5	1977.09	1980.12	53	71	EH	4		X	X	JM5355	1	Dist. 0231176057 049905705A
1.5	1977.09	1980.12	53	71	FX	4		X	X	JM5355	1	
1.5	1979.09	1980.12	46	62	FG	4		X	X	JM5355	1	
1.6	1975.09	1976.12	53	71	FN	4		X	X	JM5355	1	
1.6	1975.09	1980.12	55	76	FN	4		X	X	JM5355	1	
1.6	1977.01	1977.12	53	71	EE	4		X	X	JM5355	1	
1.6	1979.09	1980.12	55	76	EJ	4		X	X	JM5355	1	
1.6	1979.09	1980.12	55	76	EJ	4		X	X	JM5355	1	Exc. California
1.6	1980.01	1980.12	53	71	FN	4		X	X	JM5355	1	
<b>ROUTAN</b>												
3.8	2008.09	2010.12	145	197	-	6		X	X	JM5443	1	OHV
4.0	2008.09	2010.12	185	251	-	6	-	-	-	JM5375	6	SOHC
<b>SCIROCCO</b>												
1.5	1974.09	1975.12	51	70	FC	4		X	X	JM5355	1	
1.5	1977.09	1978.12	53	72	EH	4		X	X	JM5355	1	
1.6	1975.09	1976.12	57	77	FN	4		X	X	JM5355	1	
1.6	1975.09	1976.12	58	79	FN	4		X	X	JM5355	1	
1.6	1975.09	1980.12	58	79	EE	4		X	X	JM5355	1	
1.6	1979.09	1980.12	58	79	EJ	4		X	X	JM5355	1	
1.6	1980.01	1980.12	58	79	EJ	4		X	X	JM5355	1	Exc. California
<b>SEDAN</b>												
1.6	1995.01	2004.12	-	-	-	4		X	X	JM5046	1	Eng. Type-Boxer Mexico
<b>SQUAREBACK</b>												
1.6	1966.01	1967.12	-	-	P, T	4		X	X	JM5335	1	for BOSCH GT40T R1=3.0[Q], R2=8.5[kQ]
1.6	1968.01	1973.12	-	-	P, T, U	4		X	X	JM5335	1	for BOSCH GT40T R1=3.0[Q], R2=8.5[kQ]
<b>SUPER BEETLE</b>												
1.6	1971.01	1974.12	-	-	AE, AH, AK	4		X	X	JM5335	1	for BOSCH GT40T R1=3.0[Q], R2=8.5[kQ]
1.6	1975.01	1980.12	-	-	AJ	4		X	X	JM5335	1	for BOSCH GT40T R1=3.0[Q], R2=8.5[kQ]
<b>THING</b>												
1.6	1972.09	1974.12	39	52	AG, AL, AM	4		X	X	JM5355	1	for BOSCH GT40T R1=3.0[Q], R2=8.5[kQ]
1.6	1973.01	1973.12	-	-	-	4		X	X	JM5335	1	for BOSCH GT40T R1=3.0[Q], R2=8.5[kQ]



VOLKSWAGEN USA (VW)										
<b>TOUAREG</b>										
3.2 V6 DOHC 195 cid.	2004.01	2006.12	-	-	BAA, BMX	6	-	-	JM5066	6
3.6 V6 DOHC 219 cid.	2006.01	-->	-	-	BHL	6	-	-	JM5066	6
3.6 V6 FSI	2009.01	2010.12	-	-	BHK	6	-	-	JM5360	6 OE 022905715A
<b>TRANSPORTER</b>										
1.2	1954.01	1964.12	-	-	-	4	X	X	JM5335	1 for BOSCH GT40T R1=3.0[Ω], R2=8.5[kΩ] Dist. Bosch 0231137011 OE 131905205
1.5	1963.01	1967.12	-	-	-	4	X	X	JM5335	1 for BOSCH GT40T R1=3.0[Ω], R2=8.5[kΩ] Dist. Bosch 0231137011 OE 131905205
1.6	1968.01	1971.12	-	-	B, C, AD, AE, AF	4	X	X	JM5335	1 for BOSCH GT40T R1=3.0[Ω], R2=8.5[kΩ]
1.7	1972.01	1973.12	-	-	CA, CB, CD, CE	4	X	X	JM5335	1 for BOSCH GT40T R1=3.0[Ω], R2=8.5[kΩ]
1.8	1974.01	1975.12	-	-	AP, AW, ED	4	X	X	JM5335	1 for BOSCH GT40T R1=3.0[Ω], R2=8.5[kΩ]
2.0	1976.01	1979.12	-	-	CJ, GD	4	X	X	JM5335	1 for BOSCH GT40T R1=3.0[Ω], R2=8.5[kΩ]
2.5	1992.01	1993.12	80	108	AAF	5	X	X	JM5046	1 VIN (C)
<b>VAN</b>										
1.8	2008.01	2009.12	-	-	-	4	X	X	JM5046	1 Mexico
<b>VAN CAMPER</b>										
1.8	1975.01	1975.12	-	-	AP, ED	4	X	X	JM5335	1 for BOSCH GT40T R1=3.0[Ω], R2=8.5[kΩ]
2.0	1976.01	1978.12	-	-	CJ, GD	4	X	X	JM5335	1 for BOSCH GT40T R1=3.0[Ω], R2=8.5[kΩ]
2.0	1976.01	1979.12	-	-	CJ, GE	4	X	X	JM5335	1 for BOSCH GT40T R1=3.0[Ω], R2=8.5[kΩ]
2.5	1995.01	1995.12	80	108	ACU	5	X	X	JM5046	1 VIN (E)
2.5	1995.01	1995.12	81	110	ACU	5	X	X	JM5046	1 VIN (D), VIN (C)
<b>VANAGON</b>										
1.9	1983.01	1983.12	61	83	DH	4	X	X	JM5335	1 for BOSCH GT40T R1=3.0[Ω], R2=8.5[kΩ] VIN (B)
2.0	1980.01	1983.12	51	70	CV	4	X	X	JM5335	1 for BOSCH GT40T R1=3.0[Ω], R2=8.5[kΩ] VIN (A)

# ► LIST OF SYMBOLS USED

► SPIS UŻYTYCH SYMBOLI ► СПИСОК ПРИМЕНЕННЫХ СИМВОЛОВ ► LISTE DER VERWENDETEN SYMBOLE

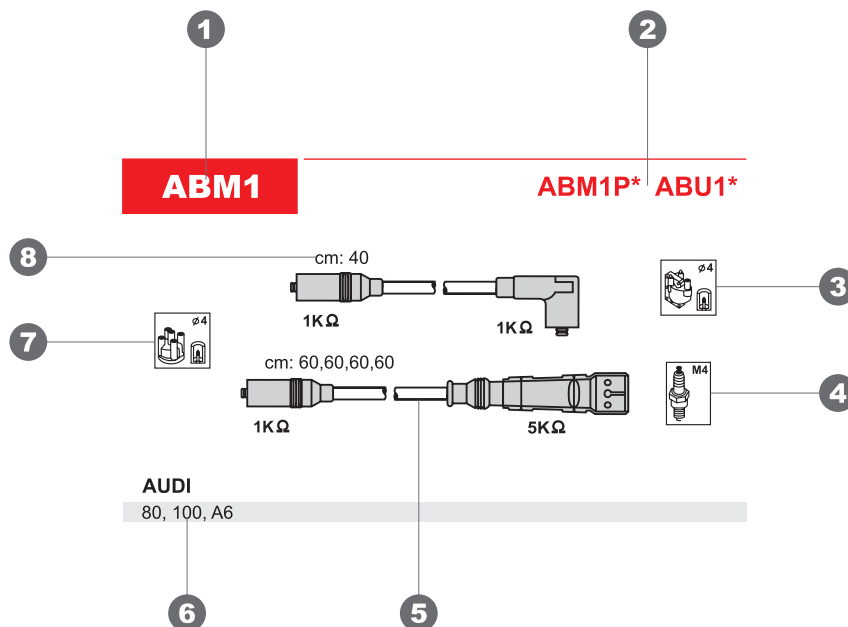

## 1 PROLINE SET SYMBOL

SYMBOL WIĄZKI PROLINE  
СИМВОЛ КОМПЛЕКТА PROLINE  
SYMBOL ZÜNDKABEL PROLINE

## 2 AVAILABLE ECOLINE SET SYMBOL

SYMBOL DOSTĘPNEJ WIĄZKI (WIĄZEK) ECOLINE  
СИМВОЛ ДОСТУПНОГО КОМПЛЕКТА (КОМПЛЕКТОВ) ECOLINE  
SYMBOL ZÜNDKABEL VERFÜGBAR ECOLINE

## 3 COIL SIDE CONNECTOR TYPE

RODZAJ ZŁĄCZA PO STRONIE CEWKI  
ВИД ПРИСОЕДИНЕНИЯ СО СТОРОНЫ КАТУШКИ  
STECKVERBINDER SEITEN SPULE

## 4 SPARK PLUG SIDE CONNECTOR TYPE

RODZAJ ZŁĄCZA NA ŚWIECĘ  
ВИД ПРИСОЕДИНЕНИЯ СО СТОРОНЫ СВЕЧИ  
STECKVERBINDER SEITEN KERZE

## 5 PROLINE SET GRAPHIC ILLUSTRATION

ILUSTRACJA GRAFICZNA KOMPLETU PROLINE  
ЧЕРТЕЖ КОМПЛЕКТА PROLINE  
ABBILDUNG SET PROLINE

## 6 VEHICLE APPLICATION

ZASTOSOWANIE W POJAZDACH  
ПРИМЕНЕНИЕ НА МАШИНЫ  
NUTZUNG EINES FAHRZEUGS

## 7 DISTRIBUTOR SIDE CONNECTOR TYPE

RODZAJ ZŁĄCZA PO STRONIE ROZDZIELACZA  
ВИД ПРИСОЕДИНЕНИЯ СО СТОРОНЫ РАСПРЕДЕЛИТЕЛЯ  
STECKVERBINDER SEITEN VERTEILER

## 8 CABLE LENGTH IN CM

DŁUGOŚĆ PRZEWODU W CENTYMETRACH  
ДЛИНА ПРОВОДА В САНТИМЕТРАХ  
ZÜNDKABEL LÄNGE IN CM

\* The Boots that are used in Ecoline sets can differ by shape from those presented on the picture. The graphic illustration of Ecoline sets is accessible in the Janmor electronic catalogues.

\* Osłony zastosowane w wiązkach Ecoline mogą różnić się kształtem od tych przedstawionych na rysunku. Ilustracja graficzna wiązek Ecoline dostępna jest w katalogach elektronicznych JANMOR.

\* Наконечники, примененные в комплектах Ecoline могут отличаться по своему виду от представленных на чертежах. Графический чертеж комплектов Ecoline доступный в электронном каталоге JANMOR.

\* Die in den Ecoline Bündeln einsetzen Ummantelungen können sich in ihrer Form von den auf dem Bild unterscheiden. Die graphische Darstellung der Ecoline Bündel ist in den elektronischen JANMOR Katalogen abrufbar.

**AM1**



cm: 35



cm: 59,73,89,89

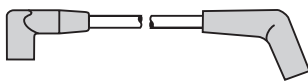

**FORD**  
Escort

**AMU1\***

**AM6**



cm: 44



cm: 59,69,73,79,89,89



**FORD**  
Aerostar, Probe, Sable, Taurus, Tempo  
**MERCURY**  
Sabel, Topaz

**AM2**



cm: 49



cm: 76,82,82,92



**FORD**  
Aerostar, Taurus

**AMU2\***

**AM7**



cm: 70,70,80,80,80,90

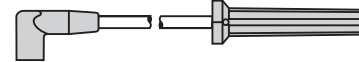

**FORD**  
Aerostar

**AM3**



cm: 44



cm: 64,70,70,74,80,90



**CHEVROLET**  
S.T. Series V6  
**JEEP**  
Cherokee

**AMU3\***

**AM8**



cm: 30,50,50,130,130,130



**BUICK**  
Le Sabre, Park Avenue, Regal, Rivera, Skylark  
**CHEVROLET**  
Beretta, Corsica, Lumina, Monte Carlo  
**OLDSMOBILE**  
98 Regency, Silhouette, Tornado  
**PONTIAC**  
Bonneville, Grand AM, Grand Prix, Trans Sport '89

**AM4**



cm: 44



cm: 42,42,46,56



**FORD**  
Taurus, Tempo

**AMU4\***

**AM9**



cm: 24



cm: 54,60,64,64,64,70

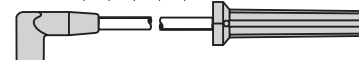

**CHEVROLET**  
Celebrity, Corsica, Lumina  
**OLDSMOBILE**  
Ciera, Cutlass  
**PONTIAC**  
Grand Prix, Trans Sport '89

**AM5**



cm: 72



cm: 62,72,92,92



**FORD**  
Escort

**AMU5\***



**AM10**

**AMU10\***



cm: 62,96,100,100,110,114

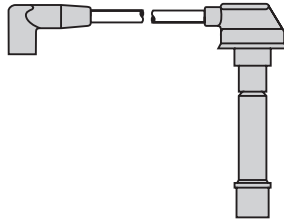

**CHRYSLER**

Concorde, Fifth Ave. Imperial, Le Baron, LHS, New Yorker, Town & Country

**DODGE**

Dynasty, Intrepid

**EAGLE**

Vision

**PLYMOUTH**

Voyager

**AM11**

**AMU11\***



cm: 36,50,54,62,72,80

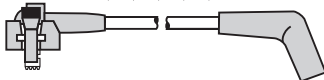

**FORD**

Taurus

**AM12**

**AMU12\***



cm: 36,48,64,66,86,90



**FORD**

Mustang

**AM13**

**AMU13\***



cm: 38,38,40,40

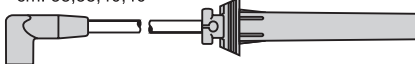

**DODGE**

Neon

**AM14**

**AMU14\***



cm: 48



cm: 64,64,64,70,74,90



**DODGE**

Neon

**AM15**

**AMU15\***



cm: 24,24,30,30

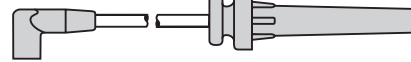

**CHRYSLER**

Cirrus, Neon, Sebring, Stratus

**DODGE**

Avenger

**EAGLE**

Talon

**JEEP**

Cherokee

**MITSUBISHI**

Eclipse

**PLYMOUTH**

Breeze

**AM16**

**AMU16\***



cm: 34,50,50,110,130,140

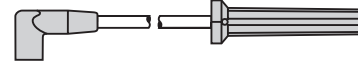

**BUICK**

Century, Regal

**CHEVROLET**

Celebrity, Lumina

**OLDSMOBILE**

Cutlass

**PONTIAC**

6000, Grand Prix, Tempest



## AM17

AMU17\*



cm: 32,46,50,124,134,138

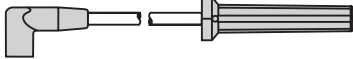

### BUICK

Century

### CHEVROLET

Beretta, Cavalier, Corsica

### OLDSMOBILE

Ciera, Cutlass

### PONTIAC

Grand Prix, Sunbird

## AM18

AMU18\*



cm: 92,92,92,104

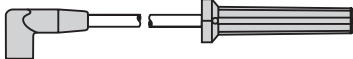

### BUICK

Century

### CHEVROLET

Beretta, Cavalier, Corsica, S.T. Series L4

### OLDSMOBILE

Ciera

### PONTIAC

Sunfire

## AM19

AMU19\*



cm: 68,68,92,104

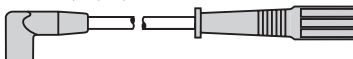

### BUICK

Century

### CHEVROLET

Celebrity

### OLDSMOBILE

Ciera

## AM20

AMU20\*



cm: 46,72,72,102,102,112

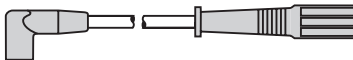

### BUICK

Century, Electra, Park Avenue, Rivera, Skylark

### CHEVROLET

Camaro, Monte Carlo

### FORD

Thunderbird

### MERCURY

Cougar

### OLDSMOBILE

88 Royale, Achieva, Calais, Ciera, Delta, Silhouette

### PONTIAC

Bonneville, Firebird, Grand AM

## AM21

AMU21\*



cm: 92,92,92,124

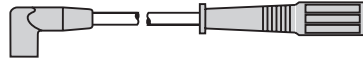

### BUICK

Skylark

### CHEVROLET

Cavalier

### OLDSMOBILE

Calais

### PONTIAC

Grand AM

## AM22

AMU22\*



cm: 46,56,56,72,92,92,104,112

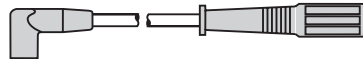

### CADILLAC

Allante, Deville, Eldorado, Seville

## AM23

AMU23\*



cm: 92,92,112

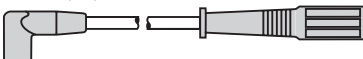

cm: 94



### CHEVROLET

Beretta, Corsica

## AM24

AMU24\*



cm: 46



cm: 56,62,68,68,82,82,92,92

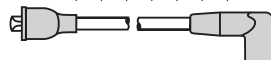

### CHEVROLET

Camaro, Corvette

### PONTIAC

Firebird

**AM25**

**AMU25\***

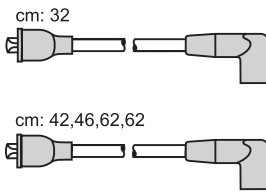

**BUICK**

Roadmaster

**CHEVROLET**

Caprice, Impala

**AM26**

**AMU26\***

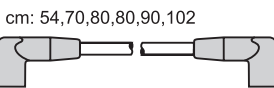

**CHEVROLET**

Camaro, Caprice

**PONTIAC**

Firebird

**AM27**

**AMU27\***

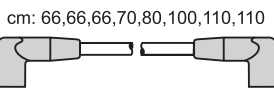

**CHEVROLET**

Corvette

**AM28**

**AMU28\***

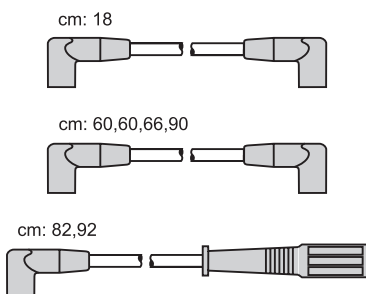

**CHEVROLET**

Caprice

**AM29**

**AMU29\***

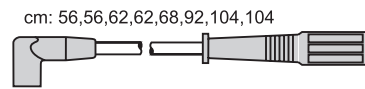

**CADILLAC**

Brougham

**CHEVROLET**

Caprice

**OLDSMOBILE**

Custom

**AM30**

**AMU30\***

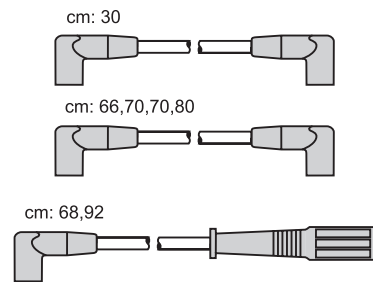

**CHEVROLET**

C-K Serie, G Series, S.T. Series V6

**OLDSMOBILE**

Bravada

**AM31**

**AMU31\***

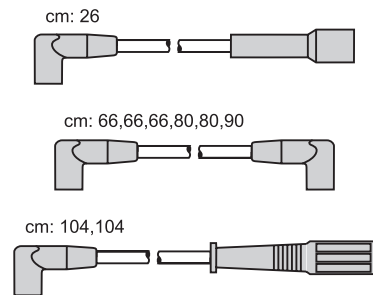

**CHEVROLET**

C-K Serie, G Series

**AM32**

**AMU32\***

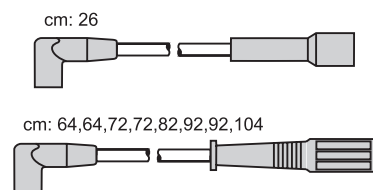

**CHEVROLET**

C-K Serie, G Series



**AM33**

**AMU33\***

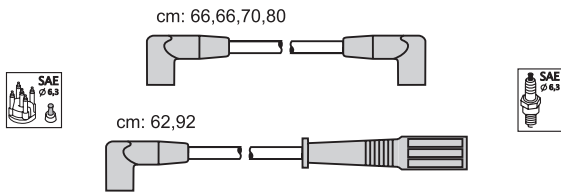

**CHEVROLET**

G Series, S.T. Series V6

**OLDSMOBILE**

Bravada

**AM36**

**AMU36\***

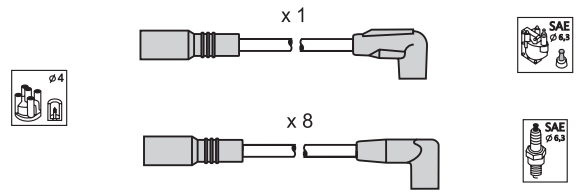

**CHEVROLET**

Camaro

**PONTIAC**

Firebird

**AM34**

**AMU34\***

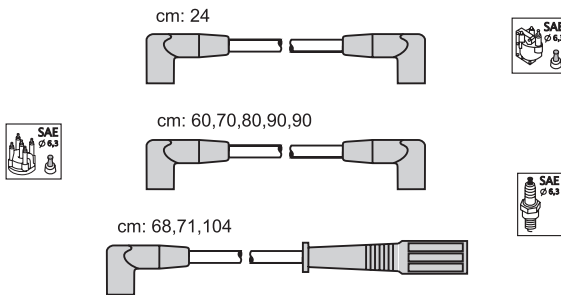

**BUICK**

Roadmaster

**CADILLAC**

Brougham

**CHEVROLET**

Camaro, Caprice, C-K Serie, G Series

**OLDSMOBILE**

Custom

**PONTIAC**

Firebird

**AM38**

**AMU38\***

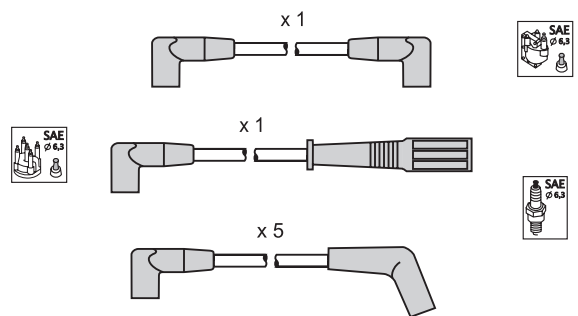

**FORD**

Bronco, Ranger

**AM39**

**AMU39\***

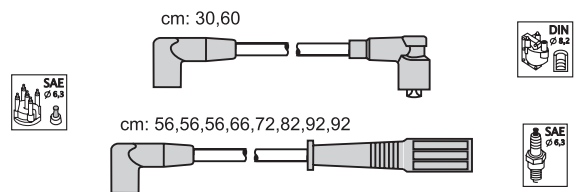

**FORD**

Country Squire, Crown Victoria, Thunderbird

**MERCURY**

Colony Park, Grand Marquis

**AM35**

**AMU35\***

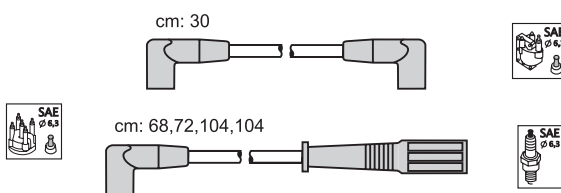

**CHEVROLET**

S.T. Series L4

**AM40**

**AMU40\***

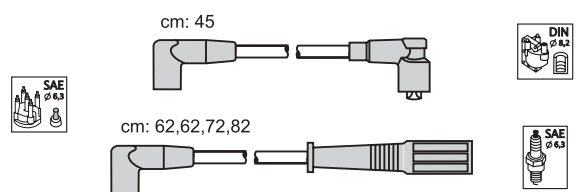

**FORD**

Mustang

**AM41**

**AMU41\***

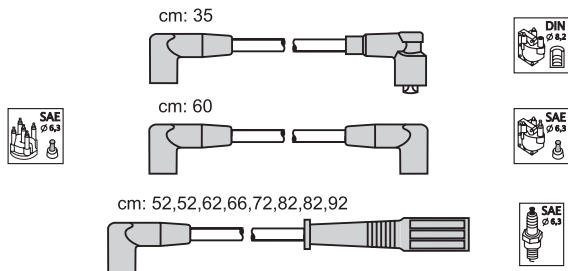

**MERCURY**

Villager

**NISSAN**

Quest

**AM46**

**AMU46\***

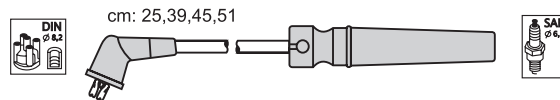

**CHEVROLET**

Lacetti, Nubira

**DAEWOO**

Lacetti, Nexia, Nubira

**AM43**

**AMU43\***

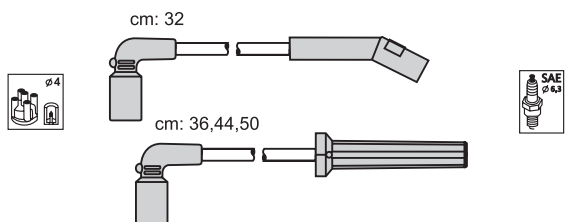

**CHEVROLET**

Aveo

**AM47**

**AMU47\***

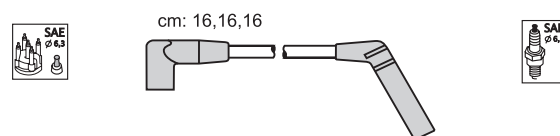

**CHEVROLET**

Matiz, Spark

**DAEWOO**

Matiz

**AM44**

**AMU44\***

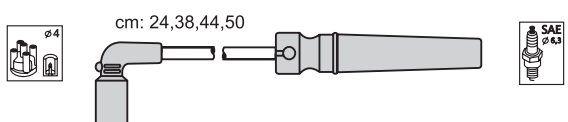

**CHEVROLET**

Aveo, Rezzo

**AM48**

**AMU48\***

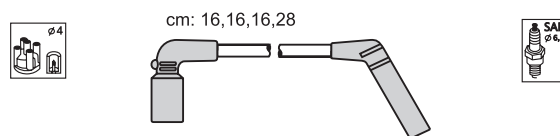

**CHEVROLET**

Aveo, Kalos, Matiz, Spark

**DAEWOO**

Kalos, Matiz

**AM45**

**AMU45\***

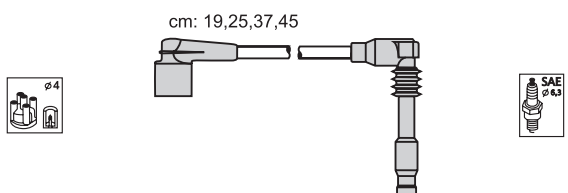

**CHEVROLET**

Captiva, Evanda, Lacetti, Nubira, Rezzo

**DAEWOO**

Evanda, Lacetti, Nubira, Rezzo

**AM49**

**AMU49\***

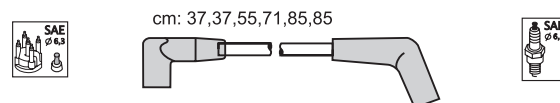

**FORD**

Mustang



**AM50**

**AMU50\***

cm: 32,46,50,60,70,76,86,116

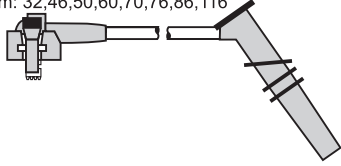

**FORD**  
Mustang

**AM54**

**AMU54\***

cm: 30,36,42,54,88,98,108,108

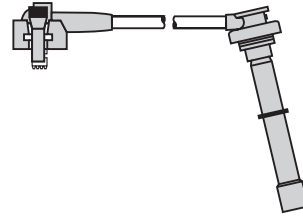

**LINCOLN**  
Continental

**AM51**

**AMU51\***

cm: 96



cm: 96



cm: 63,63,75,75,75,81,93,93



**FORD**  
Mustang

**AM55**

**AMU55\***

cm: 32,42,48,62,100,122,132,132

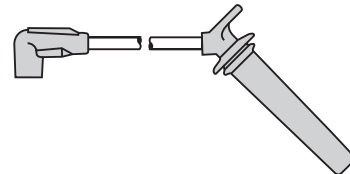

**CADILLAC**  
STS Nord Star

**AM52**

**AMU52\***

cm: 102,102,102,102,107,107,112,112

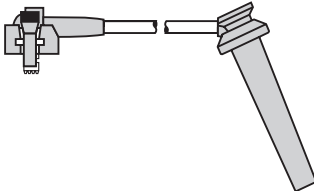

**FORD**  
Crown Victoria

**AM56**

**AMU56\***

cm: 19,25,37,53,67,93

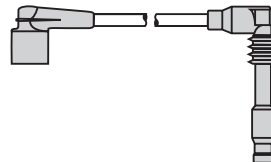

**CADILLAC**  
Catera

**AM53**

**AMU53\***

cm: 50,56,64,72,88,106,106,126

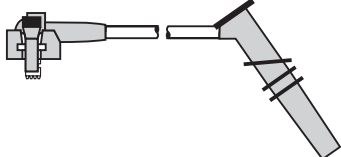

**LINCOLN**  
Continental

**AM57**

**AMU57\***

cm: 58,58,58,76,76,88

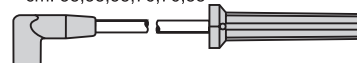

**BUICK**  
Skylark

**AM58**

**AMU58\***



cm: 52,58,60,80,82,88

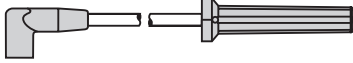

**PONTIAC**  
Montana

**AM62**

**AMU62\***



cm: 30



cm: 20,20,24,24

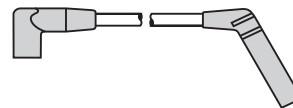

**JEEP**  
Cherokee

**AM59**

**AMU59\***



cm: 84



cm: 42,52,56,62,66,80

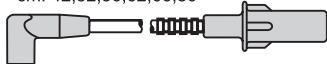

**DODGE**  
Ram

**AM63**

**AMU63\***



cm: 34



cm: 20,26,40,40

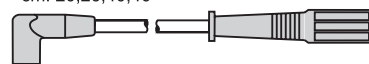

**JEEP**  
Cherokee, Wrangler

**AM60**

**AMU60\***



cm: 50



cm: 58



cm: 50,60,70,70,70,80

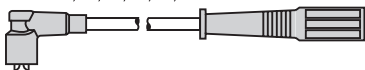

**CHRYSLER**  
Le Baron, New Yorker, Town & Country

**DODGE**  
Daytona, Dynasty, Grand Caravan, Spirit

**TRIUMPH**  
2.5, 2000, 2500, GT6, TR

**AM64**

**AMU64\***



cm: 31



cm: 30,30,30,36,40,40

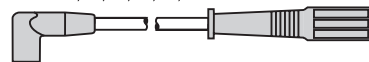

**JEEP**  
Cherokee, Comanche, Wagoneer

**AM61**

**AMU61\***



cm: 33



cm: 20,20,24,24

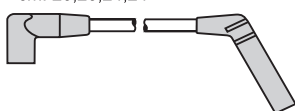

**JEEP**  
Cherokee

**AM65**

**AMU65\***



cm: 24



cm: 26,28,42,42

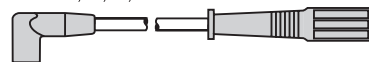

cm: 32,36

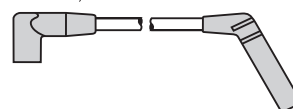

**JEEP**  
Cherokee, Comanche, Grand Cherokee, Wrangler, TJ

**AM66**

**AMU66\***

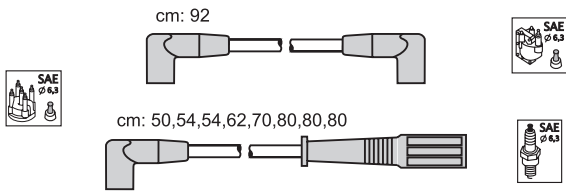

**JEEP**

Grand Cherokee

**AM70**

**AMU70\***

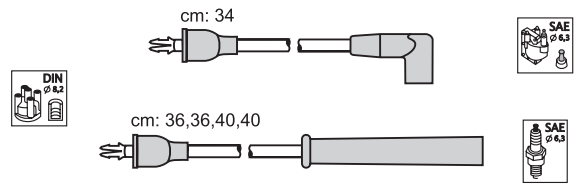

**CHRYSLER**

Voyager

**AM67**

**AMU67\***

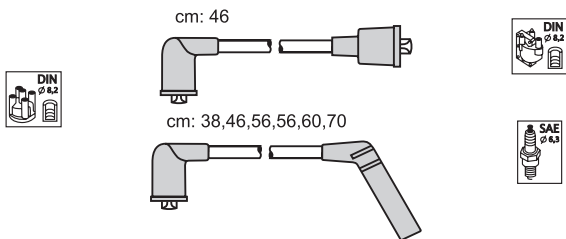

**CHRYSLER**

Voyager

**AM71**

**AMU71\***

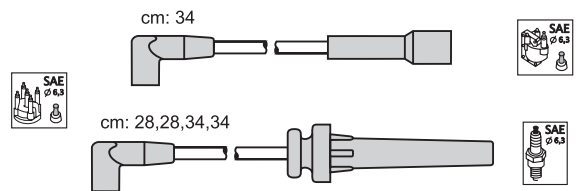

**CHRYSLER**

Voyager

**AM68**

**AMU68\***

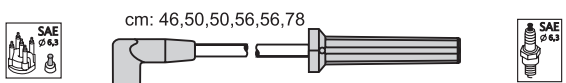

**CHRYSLER**

Voyager

**DODGE**

Caravan, Grand Caravan

**PLYMOUTH**

Voyager, Grand Voyager

**AM72**

**AMU72\***

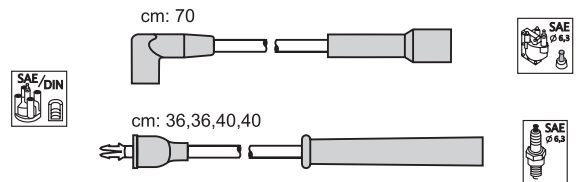

**CHRYSLER**

Laser, Le Baron, New Yorker, Town & Country, Voyager

**DODGE**

600, Caravan, Daytona, Dynasty, Grand Caravan, Lancer, Shadow, Spirit

**AM69**

**AMU69\***

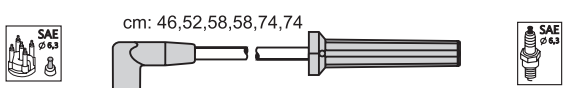

**CHRYSLER**

Voyager

**AM73**

**AMU73\***

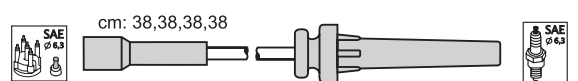

**CHRYSLER**

PT Cruiser, Sebring, Voyager



**AM74**

**AMU74\***

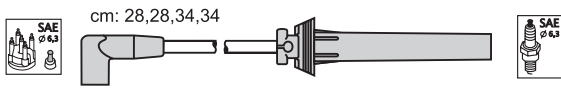

**CHRYSLER**  
Cirrus, Neon, Sebring, Stratus, Voyager

**AM78**

**AMU78\***

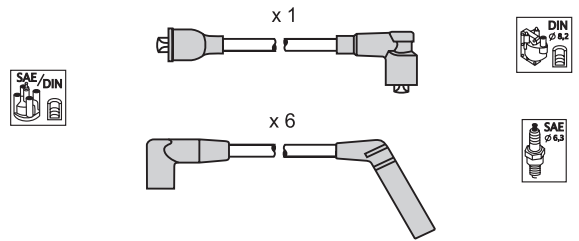

**CHRYSLER**  
New Yorker, Voyager

**AM75**

**AMU75\***



**CHRYSLER**  
Voyager

**AM79**

**AMU79\***

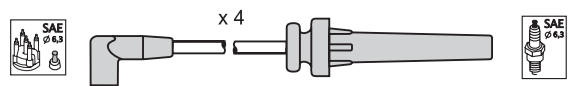

**CHRYSLER**  
GAZ, Voyager

**AM76**

**AMU76\***

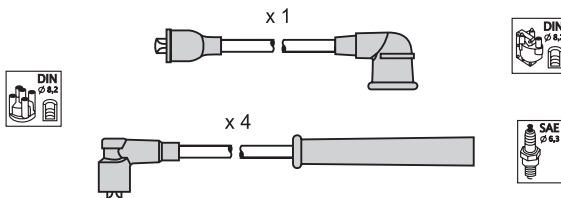

**FORD**  
Ranger

**AM80**

**AMU80\***

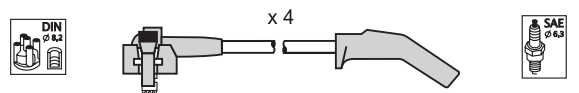

**FORD**  
Escort

**AM77**

**AMU77\***

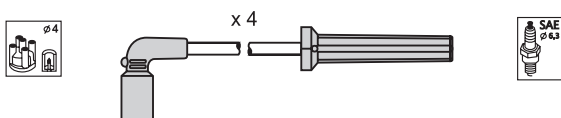

**CHEVROLET**  
Tacuma  
**DAEWOO**  
Rezzo

**AM81**

**AMU81\***

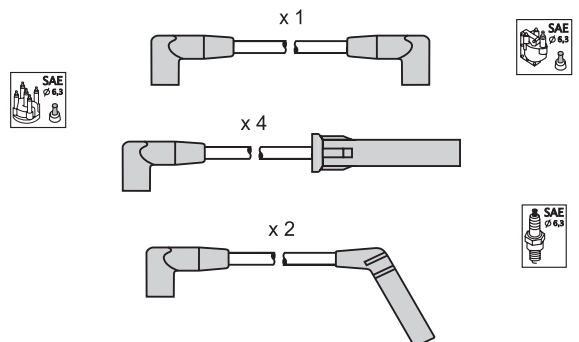

**FORD**  
F150



**AM82**

**AMU82\***

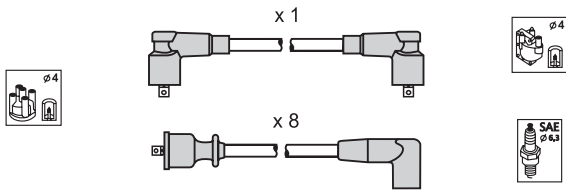

**CADILLAC**  
Escalade

**AM86**

**AMU86\***

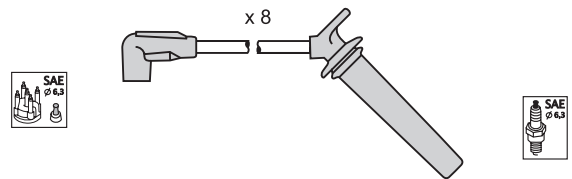

**CADILLAC**  
Seville  
**OLDSMOBILE**  
Aurora

**AM83**

**AMU83\***

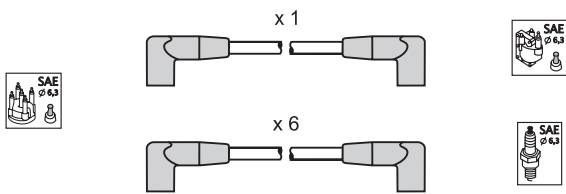

**CHEVROLET**  
Astro, Blazer, C1500, C2500, S10  
**GMC**  
Jimmy, Safari

**AM87**

**AMU87\***

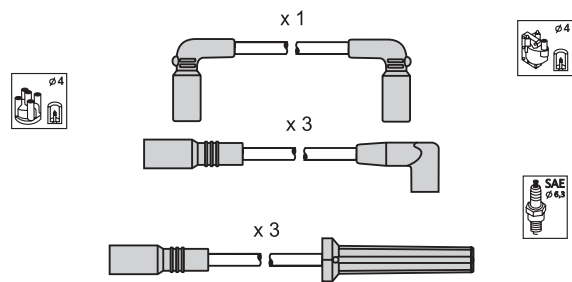

**CHEVROLET**  
Blazer

**AM84**

**AMU84\***

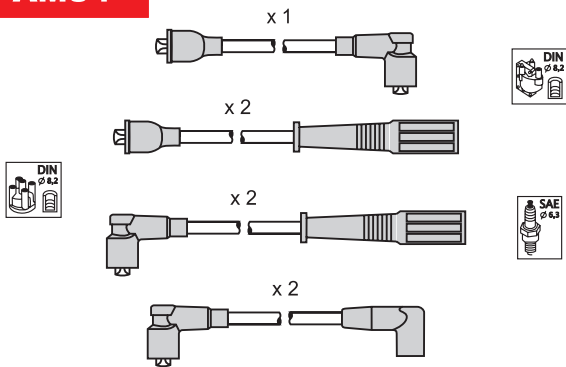

**JEEP**  
Cherokee, CJ5, Wrangler

**AM88**

**AMU88\***

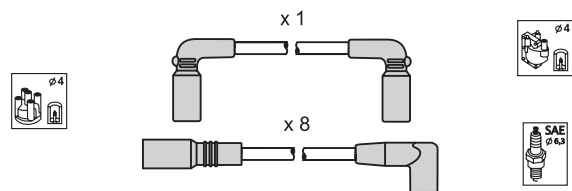

**CADILLAC**  
Escalade  
**CHEVROLET**  
C-K Series, Suburban  
**GMC**  
Suburban, Yukon

**AM85**

**AMU85\***

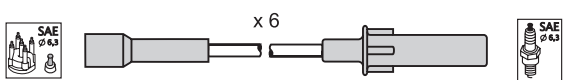

**JEEP**  
Wrangler

**AM89**

**AMU89\***

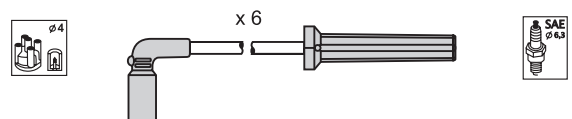

**PONTIAC**  
Torrent

**AM90**

**AMU90\***

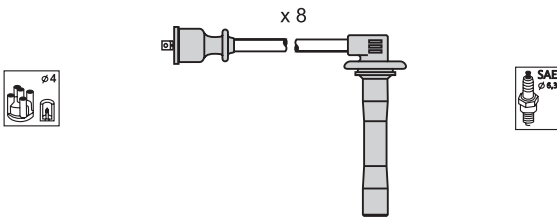

**DODGE**  
Durango

**AM91**

**AMU91\***

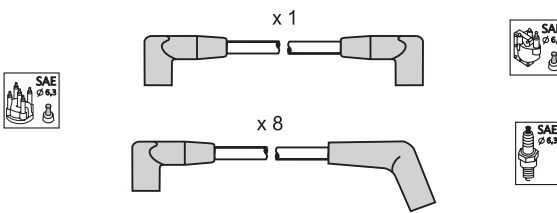

**FORD**  
Country Squire, Crown Victoria, Mustang

**LINCOLN**

Mark VII, Town Car

**MERCURY**

Colony Park, Grand Marquis

**AM92**

**AMU92\***

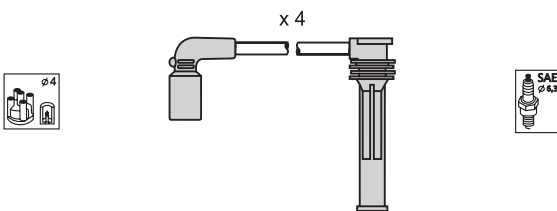

**CHEVROLET**  
Aveo

**AM93**

**AMU93\***

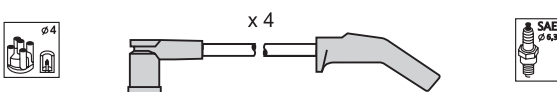

**FORD**  
Focus

**AM94**

**AMU94\***

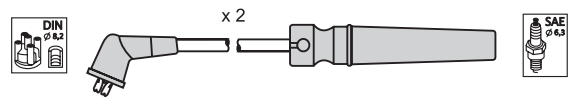

**AM95**

**AMU95\***

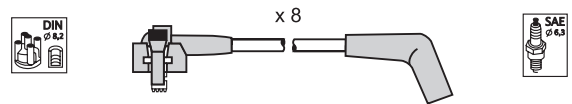

**FORD**  
Explorer

**MERCURY**  
Mountaineer

**AM96**

**AMU96\***

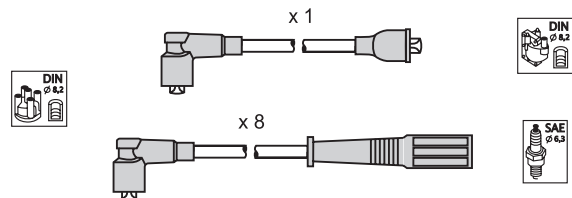

**FORD**  
Club, Country, Custom, E-150, Elite, F-100, Fairlane, Galaxie, LTD, M-400, M-450, P-350, Ranch, Ranchero, Ranger, Sunliner, Tunderbird, Torino, Victoria

**AM97**

**AMU97\***

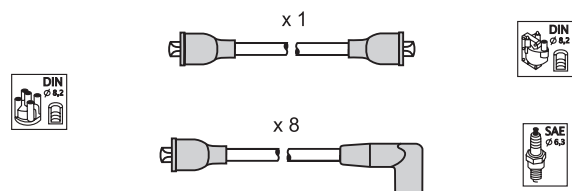

**CHEVROLET**  
Bel Air, Biscayne, Camaro

### AM98

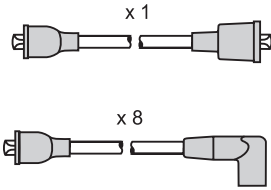

#### CHRYSLER

Cordoba, New Yorker, Newport, Town & Country

#### DODGE

Charger, Coronet, Monaco

### AMU98\*

### AFS72

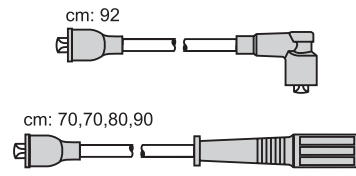

#### ALFA ROMEO

Giulietta, Spider, Duetto

### AFU72\*

### AM99

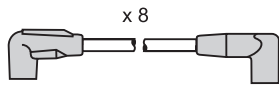

#### PONTIAC

Firebird

### AMU99\*

### CPS5

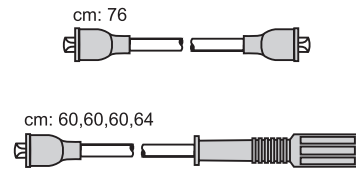

#### PEUGEOT

204, 304

#### TALBOT

Simca, Avenger, Horizon, Matra, Solara

### CPU5\*

### AM100

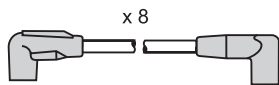

#### CHEVROLET

Corvette

### AMU100\*

### CPS19

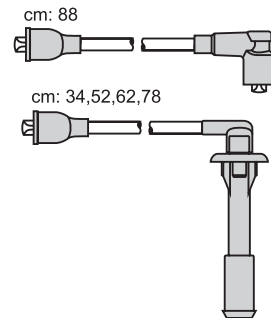

#### CITROEN

C25

#### FIAT

Ducato, Talento

#### PEUGEOT

504, 505, J5, J9

#### TALBOT

Express

### CPU19\*

### AM101

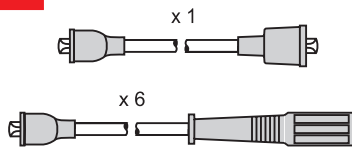

#### CHRYSLER

Le Baron, Town & Country

#### DODGE

Aspen, Coronet, Dart, Diplomat, Monaco

#### PLYMOUTH

Caravelle, Duster, Fury, Scamp, Valiant, Volare

### AMU101\*

### D7S

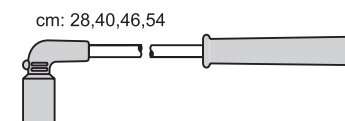

#### CHEVROLET

Aveo, Nubira

#### DAEWOO

Kalos, Lanos, Nubira

### D7E\*

### AM102

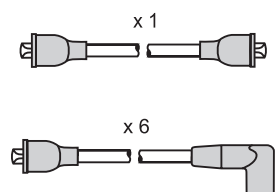

#### HUDSON

Hornet

### AMU102\*

**FS1**



cm: 54



cm: 60,64,68,74

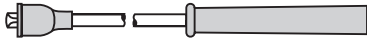

**FU1\***



**FORD**

Capri, Cortina, Escort, Fiesta, Transit

**FORD OTOSAN**

Anadol

**JAGUAR**

Fiesta

**FS41**



cm: 44

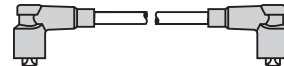

cm: 44,58,68,82

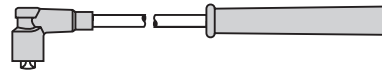

**FU41\***



**FORD**

Probe

**FS18**



cm: 50



cm: 52,62,82,82,82,82

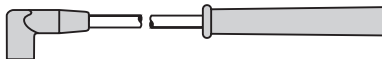

**FU18\***

**FORD**

Probe

**FS42**



cm: 47,47,75,75,85,85

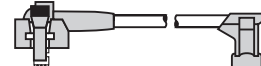

**FU42\***



**FORD**

Explorer, Mustang

**FS19**



cm: 36,36,58,76,88,88

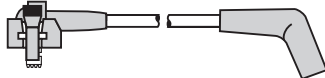

**FU19\***

**FORD**

Explorer

**HR15**



cm: 28,32,38,40

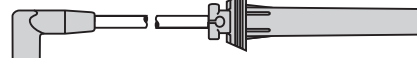

**CHRYSLER**

Neon, PT Cruiser

**MINI**

Cooper, One, Works

**FS22**



cm: 112,112,132

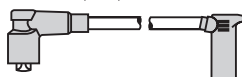

cm: 45,45,63

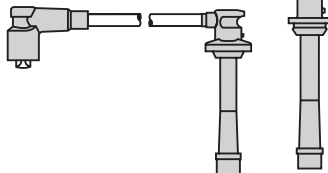

**FU22\***

**FORD**

Probe

**FS24**



cm: 49,49,61,81,91,101



**FU24\***

**FORD**

Windstar

**JP107**



cm: 44,58,68,74

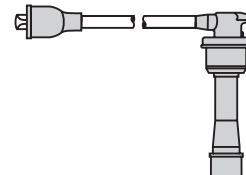

**JPE107\***

**EAGLE**

Talon

**HYUNDAI**

Lantra, Santamo, Sonata

**KIA**

Joice

**MITSUBISHI**

Colt, Eclipse, Galant, Mirage

**PLYMOUTH**

Laser



**JP109**

**JPE109\***

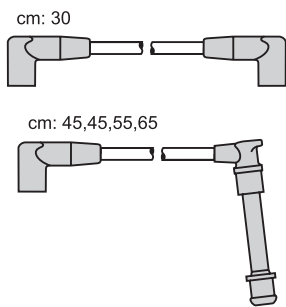

**ISUZU**  
Impulse

**JP120**

**JPE120\***

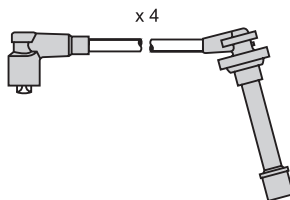

**NISSAN**  
Frontier, Xterra

**JP132**

**JPE132\***

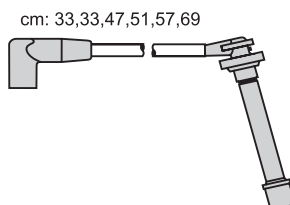

**HONDA**  
Passport  
**ISUZU**  
Rodeo

**JP134**

**JPE134\***

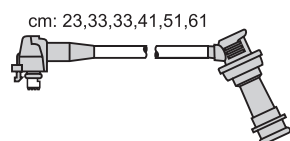

**TOYOTA**  
Supra

**JP140**

**JPE140\***

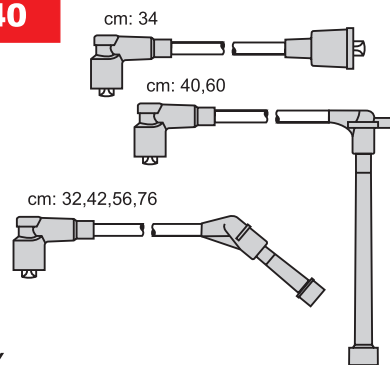

**MERCURY**  
Villager  
**NISSAN**  
Pathfinder, Quest, Terrano

**JP155**

**JPE155\***

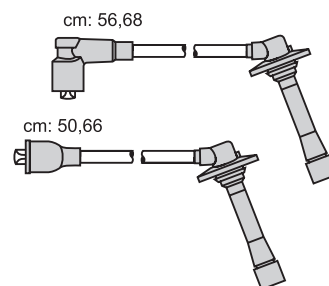

**FORD**  
Probe  
**MAZDA**  
121, 626, MX-6

**JP157**

**JPE157\***

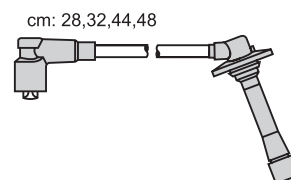

**MAZDA**  
323, Protege

**JP171**

**JPE171\***

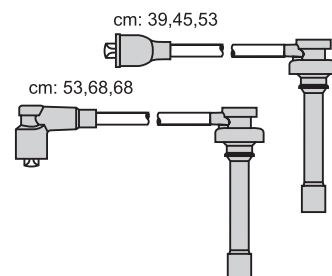

**CHRYSLER**  
Cirrus, Sebring, Stratus  
**MITSUBISHI**  
Montero, Pajero

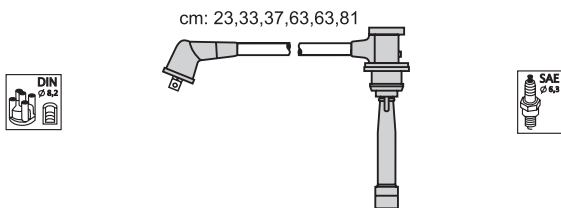
**JP178**
**JPE178\***

**HYUNDAI**

Coupe, Santa Fe, Sonata, Trajet, Tucson, XG

**KIA**

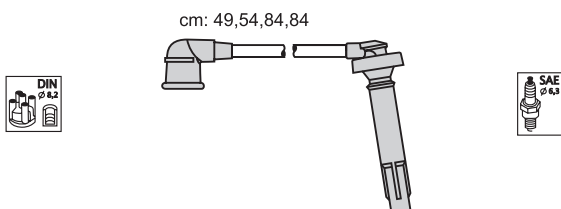
Magentis, Optima

**JP187**
**JPE187\***

**SUBARU**

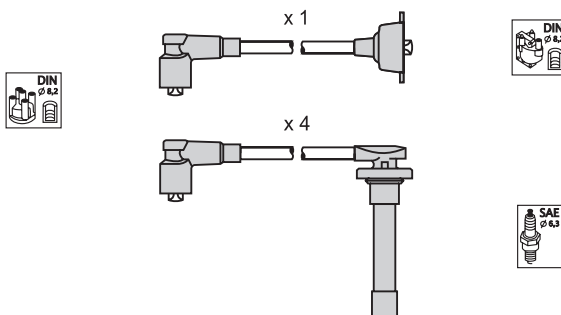
Forester, Legacy, Outback

**JP192**
**JPE192\***

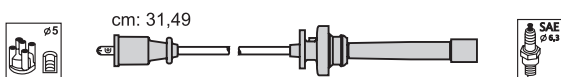
**HONDA**

Accord

**JP200**

**CHRYSLER**

Sebring

**DODGE**

Stratus

**MITSUBISHI**

Carisma, Colt, Eclipse, Galant, Grandis, Lancer, Mirage, Outlander Pajero, Space Runner, Space Star, Space Wagon

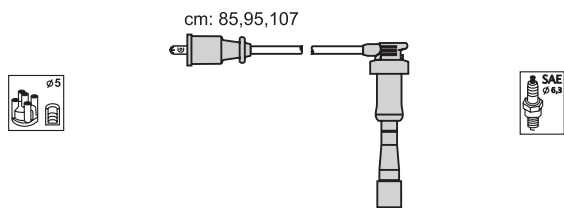
**JP208**

**KIA**

Carnival, Sorento

**MITSUBISHI**

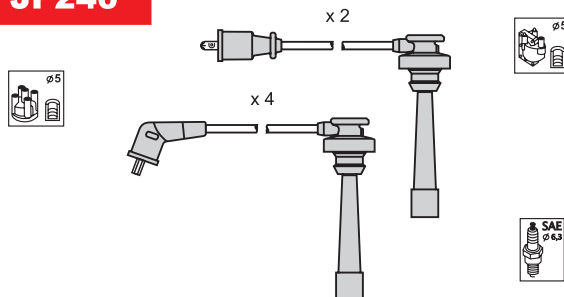
Montero, Pajero, Shogun

**JP240**

**MITSUBISHI**

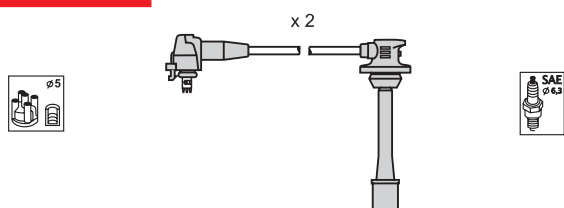
Montero, Pajero

**JP242**

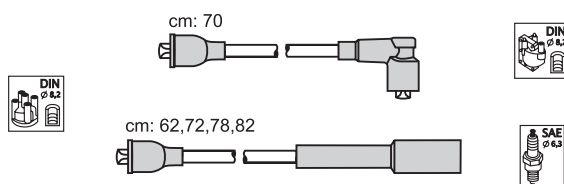
**TOYOTA**

Paseo, Tercel

**JP325**
**JPE325\***

**ACURA**

Integra

**AUDI**

60, 75, 90

**DAIHATSU**

Charade

**HONDA**

Civic, CRX, Integra, Jazz

**HYUNDAI**

Pony

**SUBARU**

Vivio, XT

**SUZUKI**

Geo Metro, Swift

**TALBOT**

180, Tagora

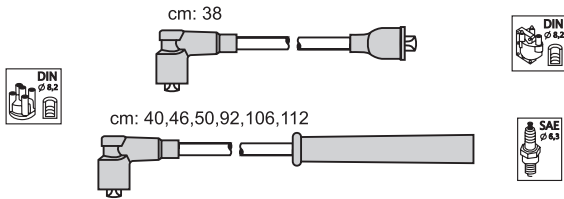

**JP362**
**JPE362\***

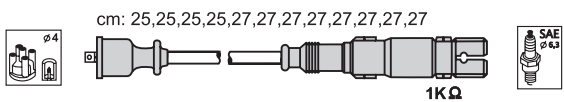
**TOYOTA**  
 4 Runner

**M19**

**CHRYSLER**

Crossfire

**MERCEDES**

280, 320 (R129); 350 (R230); C32, C230, C240, C280, C320, C350 (W203)

C32, C240, C320, C350 (S203); C32, C320, C350 (CL203)

C240, C280 (W202); C240, C280 (S202); CLK (C209); CLK (A209)

CLK (C208); CLK (A208); E240, E320 (W211); E240, E280, E320 (W210)

E240, E320 (S211); E240, E280, E320 (S210); G320 (W463)

ML320, ML350 (W163); S280, S320, S350 (W220); SLK (R170)

Viano, Vito (W639)

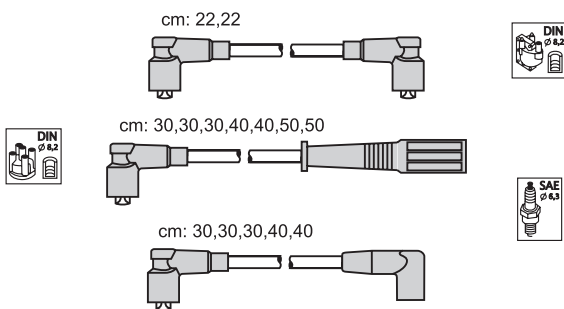
**RVS40**
**RVU40\***

**JAGUAR**

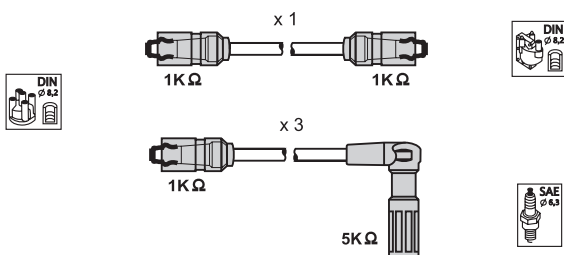
E-Type, XJ 12, XJ V12, XJS, XJSC

**SBS13**
**SBU13\***

**SAAB**

96



### JM5008

JM1200 x 4/6  
typ BERU



x 4/6

**DACIA, MORGAN, NISSAN, OPEL, RENAULT, VAUXALL**

OEM 22448-00QAA, 22448-00QAC, 22448-00QAE, 22448-6N011, 4408389, 4413233, 91159996, 7700107177, 7700113357, 7700875000, 8200154186, 8200208611, 8200380267, 8200405098, 8200568671, 8200765882

### JM5016



x 4/6

**ACURA, HONDA**

OEM 30520-P8E-A01, 30520-P8F-A01, 30520-P8F-A02, 30520-PGK-A01, 30520-PVF-A01

### JM5017



x 4

**NISSAN**

OEM 22448-4M500

### JM5018



x 3/4

**CHEVROLET, CITROEN, DAIHATSU, SUBARU, TOYOTA ...**

OEM 90080-19015, 90080-19019, 90919-02239, 90919-T2002

### JM5031



x 5

**FIAT**

OEM 46776830, 46777287

### JM5032

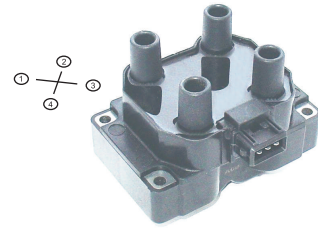

x 1/2

**ALFA ROMEO, FIAT, FSO, KIA, LAND ROVER, PEUGEOT ...**

OEM 60558152, 60809606, 76487970, 134386, ERR6045, ERR6566, 597053, 30520-PDFE-00, 0K011-18-100

### JM5038



x 1

**CHEVROLET, DAEWOO, FSO, ISUZU, OPEL, VAUXHALL**

OEM 1104038, 1208051, 96350585, 88921374, E586A, 10450424, 10490192, 8-01104-038-0

### JM5041



x 2/6/8

**CHRYSLER, JELCZ, MAN, MERCEDES-BENZ, PUCH**

OEM 0001587303, 0001587803

### JM5045



x 1

**AUDI, DACIA, SEAT, SKODA, VOLKSWAGEN**

OEM 032905106, 032905106B

### JM5046



x 1

**AUDI, SEAT, SKODA, VOLKSWAGEN**

OEM 6N0905104, 867905104, 867905104A

### JM5047



x 4

**NISSAN**

OEM 22448-1F700

### JM5056

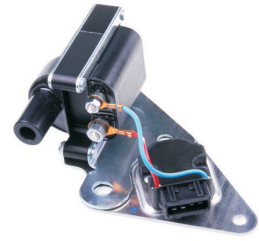

x 1

**RENAULT, VOLVO**

OEM 7401275174, 1275174

### JM5048



x 4

**NISSAN, RENAULT**

OEM 22448-6N000, 22448-6N002, 22448-6N010, 22448-6N012, 22448-6N015

### JM5057



x 5/6

**VOLVO**

OEM 30713416, 9125601

### JM5049



x 4

**NISSAN**

OEM 22448-8H300, 22448-8H310

### JM5059

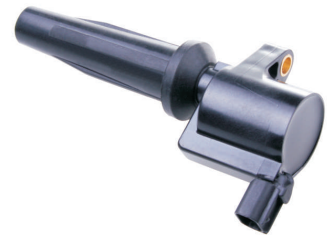

x 4

**FORD, MAZDA, MERCURY, VOLVO**

OEM 1224925, 1314271, 1322402, 4M5G-12A366-BA, 4M5G-12A366-BB 4M5G-12A366-BC

### JM5050

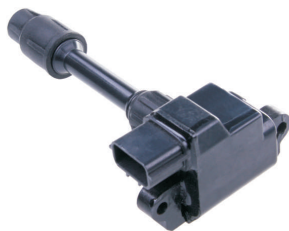

x 3

**INFINITI, NISSAN**

OEM 22448-31U06, 22448-31U16

### JM5064



x 2/4

**MAZDA**

OEM FFY1-18-100

### JM5051

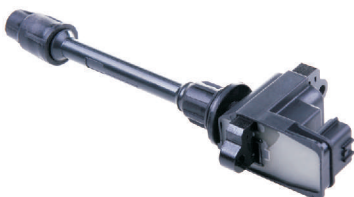

JM1186S x 3

x 3

**INFINITI, NISSAN**

OEM 22448-31U01

### JM5065



x 2/4

**KIA**

OEM OK01318100

**JM5065**

☞ x 2/4

**KIA**
**OEM** 0K01318100

**JM5070**

☞ x 1

**CHRYSLER, DODGE, EAGLE, JEEP, MINI, MITSUBISHI ...**
**OEM** 5269670, 56032521, 56032521AB, M05269670

**JM5071**

☞ x 1

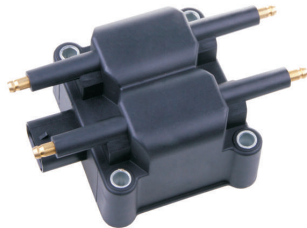
**CHRYSLER, DODGE, EAGLE, JEEP, MITSUBISHI, PLYMOUTH**
**OEM** 04557468, 04609080, 04671025, M04557468

**JM5072**

☞ x 1

**CHRYSLER, DODGE, EAGLE, PLYMOUTH**
**OEM** 4443971, 5233140

**JM5073**

☞ x 1/2

**FORD, JAGUAR, MAZDA, MERCURY**
**OEM** 6630365, 6958305, 919F-12029-AA, E9SF-12029-AA, E9SZ-12029-A, F5SU-12029-AA, F5SZ-12029-A

**JM5074**

☞ x 1

**FORD, MAZDA**
**OEM** 6383157, 90TF-12029-A1A, E9DF-12029-AA, E9DZ-12029-A, F0TZ-12029-A, F57U-12029-AA, F57Z-12029-A, F82U-12029-AA, KLG418100A, ZZLO-18-100, ZZM7-18-100

**JM5075**

☞ x 1

**FORD, MAZDA, MERCURY**
**OEM** 190171146630365, MOR1F2Z120929AC, CD0425E01DM

**JM5076**

☞ x 2/6/8/10



JM1190S x 2/6/8/10

**FORD, LINCOLN, MERCURY, MG**
**OEM** F7TU-12A336-AB, F7TZ-12029-CA, F7TZ-12029-CC, F7TZ-12029BA, F7TU-12A336-BA, F7TZ-12029-AB

**JM5077**

☞ x 6



JM1198 x 6

**JAGUAR, LINCOLN**
**OEM** 2W4E-12A366-AC, C2S42751, XR842741

**JM5078**

☞ x 8

**DAIMLER, FORD, JAGUAR, LINCOLN**
**OEM** XR827823

### JM5079



x 1



**CHEVROLET, DAEWOO, OPEL, PONTIAC, SUZUKI, ...**

OEM 96253555

### JM5087



x 6



**FORD, FPV**

OEM BA-12A366-AA, 3R2U-12A366-AA

### JM5088



x 6/8



JM1193S x 6/8

**AVANTI, FORD, FPV, LINCOLN, MERCURY, PANOZ, QVALE**

OEM 4L7E-12A366-AA, 1F3U-12A366-AA, EE03A, 6C1011

### JM5089



x 8/10



JM1197S x 8/10

**FORD, LINCOLN, MERCURY**

OEM 3L3E-12A366-CA, 3L3Z-12029-BA

### JM5091



x 1



1S7G-12029-AC



**FORD, MAZDA**

OEM 1119835, 1317972, 1319788, 1619343, 17SG-12029-AC, 1S7G-12029-AB, 1S7G-12029-AC, 988F-12029-BA, 988F-12029-AD, YMF2-12029-AB, 1F20-18-100, LF01-18-100A, LF01-18-100A Z 05, LF01-18-100

### JM5092



x 1/2



**FORD, LINCOLN, MAZDA**

OEM 1008886, 1649067, 1018139, 1018140, 6503279, 6503280, 6860288, 6860289, 88SF-12029-A1A, 88SF-12029-A2A, 88SF-12029-AA, 89BF-12024-A1B, 928F-12029-CA, 938F-12024-DA, F37Z-12029-A, F5LY-12029-A, F5OU-12029-AA, F5OY-12029-A, F5OY-12029-B, F5RZ-12029-C, 1E0518100, 1E0518100A, FSD718100, ZZM018100

### JM5104



x 1/2



**KIA, MITSUBISHI, NISSAN**

OEM KK13718-100, KK13718-10X, KK13718-10XC, KK37018-10XE, MD160532, MD166146, 22448-03E01, 22448-03E11, 22433-12-P01, 22433-12-P11, 22433-V4410

### JM5119



x 1



**HYUNDAI, KIA**

OEM 27301-37100

### JM5121



x 2

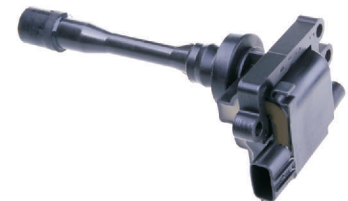

JM1194S x 2

**CHRYSLER, DODGE, MITSUBISHI**

OEM MD362907

### JM5122



x 2



**MITSUBISHI**

OEM MD363552

### JM5123



Ø8,2

x 1

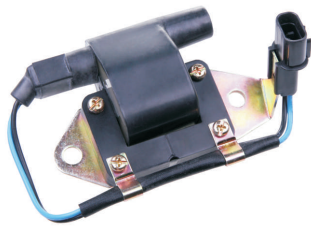

**HYUNDAI, MITSUBISHI**

OEM 27301-32800, 27301-32810, 27301-32820, 27301-35020, MD104696

### JM5129



Ø8,2

x 1



**CHRYSLER, MITSUBISHI, NISSAN**

OEM MD113551, MD131711

### JM5132



x 3/6



JM1186S x 3/6

**INFINITI, NISSAN**

OEM 22448-2Y000

### JM5133



x 3/6



JM1187S x 3/6

**INFINITI, NISSAN**

OEM 22448-2Y005

### JM5135



Ø8,2

x 1

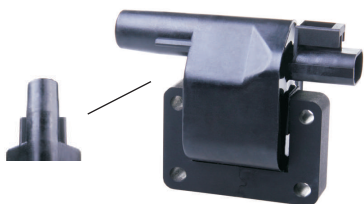

**FORD, INFINITI, MAZDA, MERCURY, NISSAN**

OEM 1953302, 1953306, F3XA-12029-AA, F3XY-12029-A, F5XZ-12029-AA, 22433-56E11, 22448-0C801, 22448-0C802, 22433-53J20, 22433-0B00, 22433-0B001, 22433-0B010, 22433-51J10, 22433-55S10, 22448-56E12, 22448-D4000

### JM5143



Ø4

x 3



**TOYOTA**

OEM 90919-02212

### JM5144



x 4/6



**LEXUS, PONTIAC, TOYOTA**

OEM 90919-02244, 90919-02243, 90919-02234, 90919-02247, 90919-02248

### JM5145



x 1



**GEO, HOLDEN, ISUZU, TOYOTA**

OEM 90919-02164

### JM5148



Ø8,2

x 1/2



**LEXUS, TOYOTA**

OEM 90919-02185

### JM5149



Ø5

x 1/2



**LEXUS, TOYOTA, VOLKSWAGEN**

OEM 90919-02208, 90919-02197, 19500-74050, 19500-74040

### JM5150



 x 1

**GEO, HOLDEN, TOYOTA**

OEM 90919-02163

### JM5174



 x 1

**ACURA, HONDA, ROVER**

OEM 30500-P0A-A01, 30500-POH-A01, 30500-PAA-A01, 30500-PCA-003, 30500-PDA-E01, GCL207, NEC100750

### JM5152



 x 1



**MAZDA, SUZUKI**

OEM F21018100, JF0118100B, F21018100B, F21118100A, E92Z-12029-B, E8GY-12029-B

### JM5175



 x 1



**MITSUBISHI**

OEM H3T031

### JM5156



 x 1



**ACURA, HONDA, HYUNDAI, ROVER**

OEM 30510-PT2-006, 30510-P73-A01, 30510-P73-A02, NEC100530, GCL195

### JM5178



 x 1



**SUBARU**

OEM 22433-AA240, 22433-AA370

### JM5161



 x 1

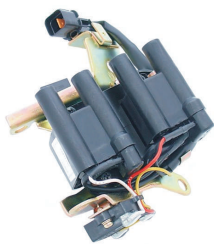

**HYUNDAI, MITSUBISHI**

OEM 27301-33010, 27301-33020, MD126461

### JM5180



 x 1



**CHEVROLET, GEO, HOLDEN, TOYOTA, VOLKSWAGEN**

OEM J9091902139, 94840127, 94847392, 9091902135, 9091902139, 9091902196

### JM5166



 x 3/6



**HYUNDAI, KIA**

OEM 27301-3E100

### JM5181



 x 1/2

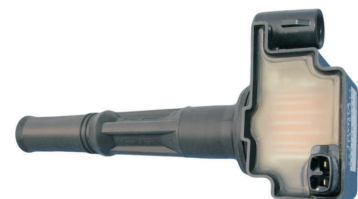

**TOYOTA**

OEM 90919-02213

**JM5182**



x 6/8

**LEXUS, TOYOTA**

OEM 90919-02250

**JM5183**

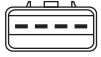

x 3

**TOYOTA**

OEM 90919-02237

**JM5184**



x 6/8

**LEXUS, TOYOTA**

OEM 90919-02230

**JM5187**

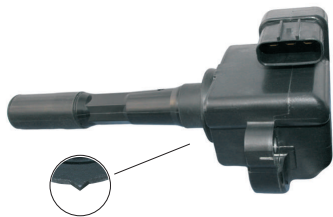

x 3

**ACURA**

OEM 30520-PR7-A33

**JM5188**

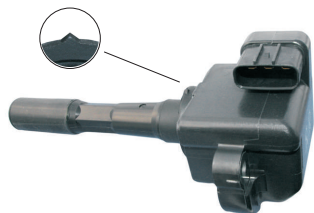

x 3/6

**ACURA**

OEM 30521-PR7-A33

**JM5192**



ø8,2

x 1

**ACURA, HONDA**

OEM 30520-PH6-902, 30500-PH6-900

**JM5193**



ø8,2

x 1

**ACURA**

OEM 30510-PV1-A01

**JM5194**

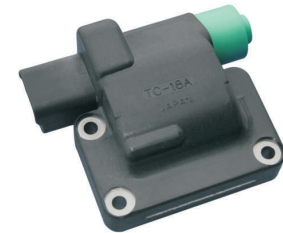

ø8,2

x 1

**HONDA**

OEM 30520-PT3-A02

**JM5195**



ø8,2

x 1

**HONDA**

OEM 30520-POG-A02

**JM5197**



ø4

x 1

**DODGE, EAGLE, MITSUBISHI, PLYMOUTH, PROTON**

OEM H3T024

### JM5198



x 1



**DODGE, EAGLE, MITSUBISHI, PLYMOUTH**

OEM H3T011

### JM5210



x 1



**ALFA ROMEO, AUDI, AUSTIN, BENTLEY, BMW, FIAT, FORD ...**

OEM 60744199, 12131359637, DM21208B, 82303852, A790X-12KO18-CA, 5006104, 1505155, 30500-634-015, 98136-0005, 2101-37050-560, 0001583403, MD017612, 22433-L6801, 1208018, 597010, 92860250200, 61660210900, 0854269800, 7700552370, 7308604, 82988-4110, 90919-02027. ....

### JM5218



x 1



**CHEVROLET, DAEWOO**

OEM 96291054

### JM5219



x 1

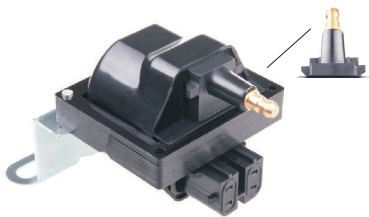

**CHEVROLET, DAEWOO, GMC USA**

OEM 96165049, 01115467

### JM5220



x 1/4

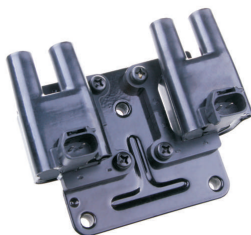

**CHEVROLET, DAEWOO**

OEM 96453420

### JM5221

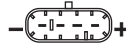

x 2



**JAGUAR**

OEM DAC4608

### JM5236



x 1

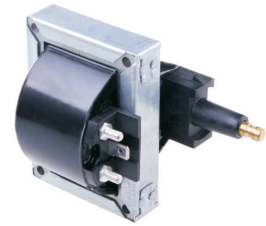

**ALPINE, JEEP, RENAULT, VOLVO**

OEM 7701031135, 3287677, T1031135

### JM5242



x 1

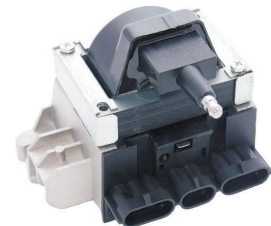

**JEEP, PEUGEOT, RENAULT**

OEM 7700852662 7700722070 7700732263 7700749146  
7700857551, 7700852093

### JM5269



x 5



JM2047 x 5

**AUDI**

OEM 034905101, 034905105

### JM5281



x 6/8



**CHEVROLET, CHRYSLER, DODGE, JEEP**

OEM 56028394



### JM5282



 x 6

**CHEVROLET**

OEM 96414260

### JM5286

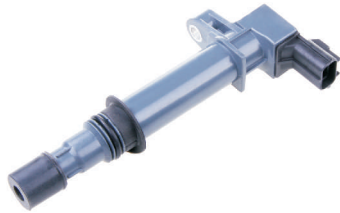

 x 6/8

**CHRYSLER, DODGE, JEEP, MITSUBISHI**

OEM 56028138, 56028138AB, 56028138AD, 56028138AE, 56028138AF

### JM5287



  $\varnothing 6,3$

 x 1

**CHRYSLER, DODGE, JEEP, PLYMOUTH**

OEM 56028172, 56028172AB

### JM5288



  $\varnothing 6,3$

 x 1

**CHRYSLER, JEEP**

OEM 4797293, 5234210, 5234610, 5252577, 53008068, 56027965, 19017110

### JM5289

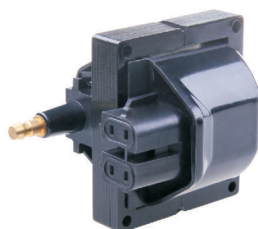

  $\varnothing 6,3$

 x 1

**CHEVROLET, DAEWOO, JEEP**

OEM 83502140, 1115468, 820133, 823294, 824728, 824987, 814541, 813597, 10477208, 1115491, 1115466, 1115324, 1115317, 1115315, 1871561, 1841856, 19005205, 8-01115-466-0, 8-01115-315-0

### JM5290



  $\varnothing 6,3$

 x 2/3/4

**BUICK, CADILLAC, CHEVROLET, ISUZU, OPEL, PONTIAC ...**

OEM 10477602, 10468391, 01103759, 10467067, 1103662, 1103759, 10495121, 1103646, 10472401, 10497771, 8-01103-830-0, 8-10468-391-0, 8-10472-401-0

### JM5293

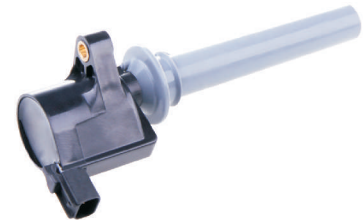

 x 6

**FORD, MAZDA, MERCURY**

OEM 2M2Z-12029-AC, 2M2E-12A366-AC, AJ51-18-100, AJ51-18-100A

### JM5300

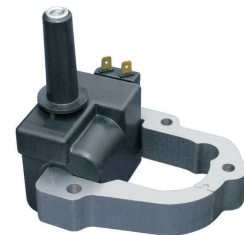

 x 1

**FORD, MAZDA, NISSAN**

OEM CM1T-216A

### JM5302



  $\varnothing 8,2$

 x 1

**FORD, MAZDA, MITSUBISHI, PROTON**

OEM H3T022

### JM5304



  $\varnothing 8,2$

 x 1

**EUNOS, FORD, MAZDA**

OEM H3T021

**JM5305**



**CHRYSLER, DODGE, MAZDA**

OEM H3T023

**JM5317**



**CHRYSLER, DODGE, MITSUBISHI**

OEM H3T04173

**JM5307**



**FORD, MAZDA**

OEM H3T03671

**JM5318**



**FORD, MAZDA, NISSAN**

OEM CM1T-227

**JM5308**



**FORD, MAZDA**

OEM H3T03374

**JM5319**

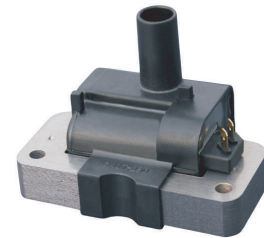

**INFINITI, MERCURY, NISSAN**

OEM CM1T-230

**JM5313**



**MITSUBISHI, PROTON**

OEM H3T03471

**JM5321**

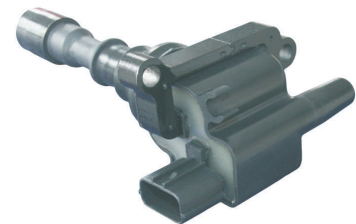

**HYUNDAI, KIA**

OEM 27300-39800, 37300-39800

**JM5316**



**DODGE, MITSUBISHI**

OEM H3T04172

**JM5323**



**DAIMLER, JAGUAR**

OEM LHE 1510AB, 4443006, 6033236

### JM5325



x 1

**MAZDA**

OEM B61P-18-10XB, B61P-18-10XC, B61P-18-10XD

### JM5326



x 1/2

**EAGLE, MITSUBISHI, PLYMOUTH**

OEM 96067256, MD149766, MD158956, 88921261

### JM5327



x 1/2/3/4

**DODGE, EAGLE, LAND ROVER, MITSUBISHI**

OEM MD152648, 88921259, 88921260, 88921338, ERR4493, ERR6269, MD179787, MD184230, MD334558, MD346835

### JM5331



x 6

**INFINITI, NISSAN, RENAULT, SUZUKI**

OEM 22448-8J11C, 22448-8J111, 22448-8J115, 22448-8J225

### JM5332



x 6

**LEXUS, TOYOTA**

OEM 90080-19016, 90019-02234

### JM5333



x 4

**PONTIAC, TOYOTA**

OEM 90919-02238

### JM5334



x 1/2

**CITROEN, DODGE, FORD, HONDA, LANCIA, RENAULT ...**

OEM GT40RT

### JM5335



x 1

**BMW, FIAT, FORD, HONDA, LANCIA, PEUGEOT, TOYOTA ...**

OEM GT40T

### JM5336



x 1

**FORD**

OEM ADG5001, EE12024A

### JM5337



x 1/4

**FORD, MAZDA, MERCURY**

OEM F0BZ-12029-A, F1CZ-12029-A, B6S7-18-100, B6S7-18-10XA, B6S8-18-10XA, F269-18-10X, F2G8-18-10X, F2G9-18-10X

**JM5338**



Ø8,2

x 1

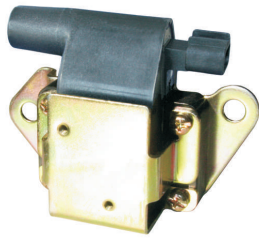

**MITSUBISHI**

OEM MD338169

**JM5340**



x 6



**FORD, MAZDA, MERCURY**

OEM 1L8E-12A366-AC, 1L8U-12A366-11, 1L8Z-12029-AB, 1L82-12029-AB, AJ03-18-100, AJ09-18-100

**JM5342**



Ø8,2

x 1

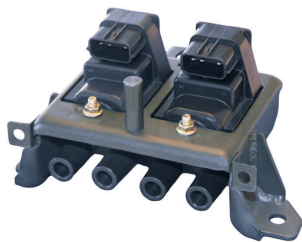

**MAZDA**

OEM BPE8-18-10XB, BPE8-18-10XC, BPE8-18-10XC-9U

**JM5343**



x 4



**HONDA**

OEM 30520-PWC-003

**JM5344**



x 4



**HYUNDAI, KIA**

OEM 27301-26640

**JM5345**

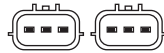

Ø8,2

x 1



**MAZDA**

OEM FPY2-18-10X, FP39-18-10XB, FP39-18-10XC, FP39-18-10XD

**JM5346**

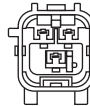

x 1



**HYUNDAI, KIA**

OEM 27310-23900, ADG014101, 5C1623

**JM5347**

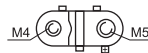

Ø8,2

x 3



**HYUNDAI, KIA**

OEM 27310-37100

**JM5355**



Ø8,2

x 1



**ALFA ROMEO, AUDI, BMW, CITROEN, FIAT, FORD...**

OEM 116556507900/00, 116556507901/00

**JM5356**



x 8/12



**MERCEDES-BENZ**

OEM 5C1227

**JM5358**



x 1

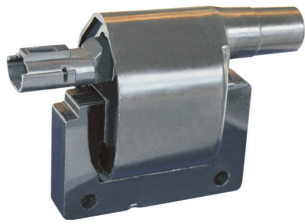

**HONDA, ISUZU, OPEL**

OEM 94371838, 8-943371-838-0, 4304227

**JM5359**



x 4



**DACIA, MORGAN, NISSAN, OPEL, RENAULT, VAUXHALL**

OEM 22448-00QAA, 22448-QAH, 4408389, 4413233, 4432202, 91159996, 93161188, 93161948, 7700875000, 8200154186, 8200208611, 8200380267, 8200405098, 8200568671

**JM5360**



x 6



**AUDI, SKODA, VOLKSWAGEN,**

OEM 022905715A

**JM5365**

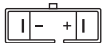

x 1

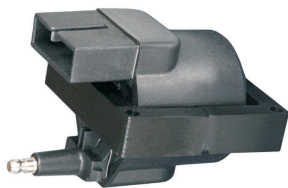

**FORD, LINCOLN, MAZDA, MERCURY**

OEM E2FZ-12029-A, E3FZ-12029-A, E73Z-12029-A, F32Z-12029-A, F3FU-12029-AA, F5FZ-12029-A, F7PZ-12029-AA, FS15-18-10X, ZZM1-18-100, ZZM4-18-100

**JM5366**



x 1



**BUICK, CADILLAC, CHEVROLET, OLDSMOBILE, PONTIAC**

OEM

**JM5367**



x 1

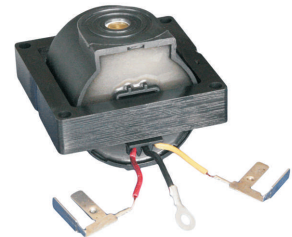

**BUICK, CADILLAC, CHEVROLET, OLDSMOBILE, PONTIAC**

OEM

**JM5368**



x 1

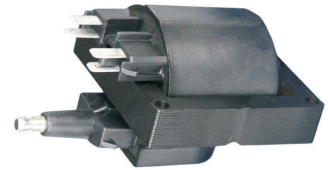

**BUICK, CADILLAC, CHEVROLET, OLDSMOBILE, PONTIAC**

OEM

**JM5369**



x 1

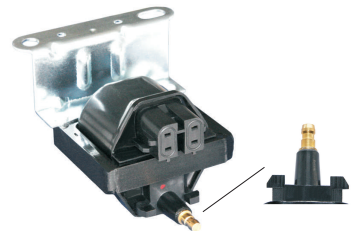

**BUICK, CADILLAC, CHEVROLET, OLDSMOBILE, PONTIAC ...**

OEM

**JM5372**



x 4/5/6/8



**INFINITI, NISSAN, RENAULT**

OEM 22448-ED000, 22448-JA00A, 22448-JA00C, 22448-EN200,

**JM5373**



x 4/8



**HYUNDAI, KIA**

OEM 27300-3F100

### JM5374



x 4/6

**SUZUKI USA**

OEM 33400-65J00

### JM5375



x 4/6

**CHRYSLER, DODGE, VOLKSWAGEN**

OEM 04606869AB, 04606869AC, 4606869AB, 4606869AC

### JM5379



x 3/6

**HYUNDAI, KIA**

OEM 27301-3E400

### JM5383



x 4/6

**ACURA, HONDA**

OEM 30520-PMA-007;30520-PNA-007;30520-RAA-007;  
30520-RRA-007

### JM5384



JM1189S x 4

x 2

**BUICK, CHEVROLET, OLDSMOBILE, PONTIAC**

OEM 10457109;10472748;10497477;19166375

### JM5385

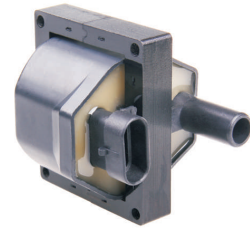

x 1

**BUICK, CHEVROLET, GMC, OLDSMOBILE, PONTIAC ...**

OEM

### JM5386



x 1

**CHEVROLET, LADA**

OEM 2111-3705010;2111-3705010-03;2111-3745010;9311600

### JM5387



x 1

**JEEP**

OEM 4762311;4762312

### JM5388



x 1

**CHEVROLET, CHRYSLER, DODGE, PLYMOUTH**

OEM 04609140AB;4609140AB

### JM5392



x 8

**INFINITI**

OEM 22433-AR215, 22448-AR215

**JM5393**

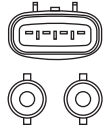

x 1



**TOYOTA**

OEM 90919-02219

**JM5394**



x 6



**LEXUS, TOYOTA**

OEM 88921328 (AC Delco), 90919-02211, 90919-02214, E584

**JM5395**



x 6



**TOYOTA**

OEM 90919-02205, 88921328 (GM), 90919-03002

**JM5397**



x 4

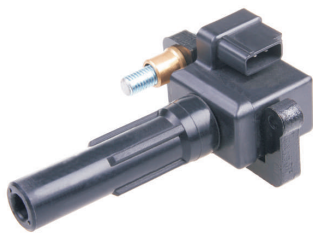

**SUBARU**

OEM 22433AA421, 22433AA560, 22433-AA421, 22433-AA560

**JM5398**



x 4

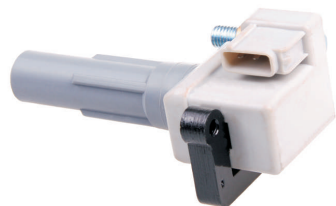

**SAAB, SUBARU**

OEM 22433-AA418, 22433-AA480, 22433-AA540, 22433-AA640

**JM5399**



x 4

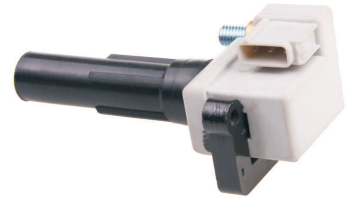

**SAAB, SUBARU**

OEM 22433AA451, 22433AA550, 22433-AA451, 22433-AA550

**JM5400**



x 1

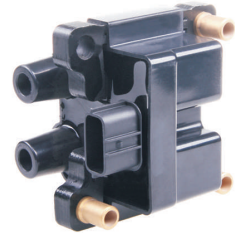

**SAAB, SUBARU**

OEM 22433-AA580, 22433-AA58A

**JM5401**



x 6/8

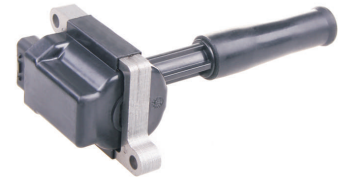

**DAIMLER, JAGUAR**

OEM LNE1510AB, XW93-12029-AB

**JM5404**



x 4



**CHEVROLET, CHRYSLER, DODGE, JEEP**

OEM 04606824AB, 4606824AB

**JM5405**



x 4/5/6



**BUICK, CHEVROLET, GMC, HUMMER, SAAB**

OEM 12496547, 12596547, 12612369, 12629472, 8125965470, H0A-085-53, H0A08553, H6T15273ZC



**JM5406**

 x 8

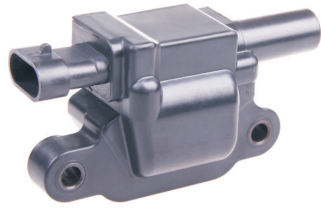

**CADILLAC, CHEVROLET, GMC, HUMMER, ISUZU, SAAB...**

OEM 12570616, 12611424, 2125706160, 8125706160, 8-12570-616-0, H6T55271ZC

**JM5417**

 x 6



**INFINITI, NISSAN**

OEM 22433-AL615, 22433-AL61C, 22448-AL615, 22448-AL61C, 22448-AL615, 22448AL615, 22448AL61C,

**JM5407**

 x 6



**JAGUAR**

OEM C2S11480, C2S42673, C2S7928, XR822478, N743V, 6R83-12A366-BA

**JM5421**

 x 8

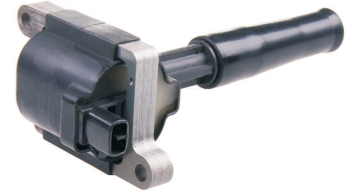

**JAGUAR**

OEM 88921407, E510C, LCA1510AB

**JM5409**

 x 5/6

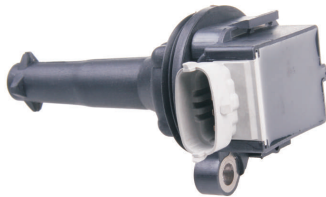

**FORD, VOLVO**

OEM 1371601, 6M5G-12029-AA, 6M5G12029AA, 30713417, 30713417-0, 8677837, 8677837-0

**JM5422**

 x 8



**CHRYSLER, JEEP**

OEM A06X0502602, A0890805763, 56028129AB, 56029129AA, 56029129AB, 68060346AA

**JM5412**

 x 1

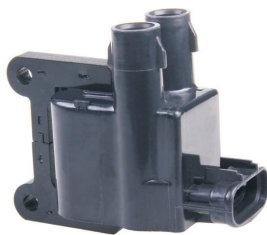

**TOYOTA**

OEM 90919-02220, 90919-02226

**JM5423**

 x 4



**HONDA**

OEM 30520-R40-007

**JM5416**

 x 4/6/8



**LEXUS, TOYOTA**

OEM 90919-02247, 90919-02248, 90919-T2005, 90919-A2001, 90919-C2002

**JM5424**

 x 8



**INFINITI, NISSAN**

OEM 22448-7S015



### JM5425



Car icon x 1

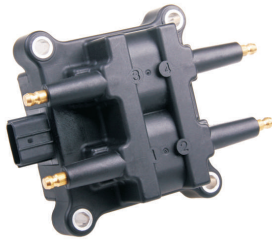

**SUBARU**

OEM 22433-AA400

### JM5426



Car icon x 6



**ALFA ROMEO, CADILLAC, CHEVROLET, GMC, OPEL, SAAB...**

OEM 012566569, 012583514, 1208039, 12566569, 12583514, 12613051, 12613057, 12629037, 71753911

### JM5427



Car icon x 3



**LEXUS, TOYOTA**

OEM 90080-19012, 90919-02215

### JM5428



Car icon x 6

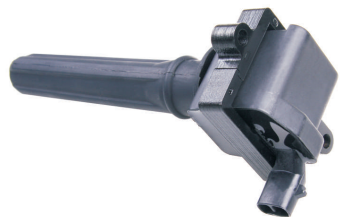

**CHRYSLER**

OEM 04609095AC, 04609095AD, 04609095AF, 4609095AB, 4609095AC, 4609095AD, 4609095AE, 4609095AF, 4609095AG, 4609095AH, 4609095AI, 88921395

### JM5429



Car icon x 6

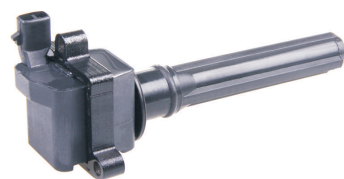

**CHRYSLER, SAAB USA**

OEM 04609088AC, 04609088AD, 04609088AF, 4609088AC, 4609088AD, 4609088AF, 4609088AG, 4609088AH, 88921394,

### JM5430



Car icon x 5/6



**HUMMER, ISUZU, SAAB**

OEM 12568062, 12568062, 8125680620, 8-12568-062-0

### JM5433



Car icon x 6



**LEXUS, TOYOTA**

OEM 90919-02246

### JM5434



Car icon x 2



**CHEVROLET, TOYOTA**

OEM 90919-02224

### JM5435



Car icon x 6



**LEXUS, TOYOTA**

OEM 90080-19025

### JM5439



Car icon x 8



**CADILLAC, CHEVROLET, GMC, HUMMER, ISUZU, SAAB ...**

OEM 12573190, 8125733190

**JM5440**



 x 8

**BUICK USA, CADILLAC**

OEM 12594176

**JM5442**

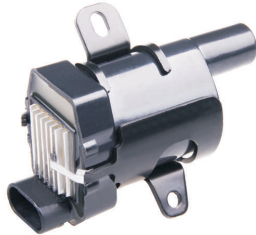
 x 6/8



**CADILLAC, CHEVROLET, GMC, HUMMER, ISUZU**

OEM 10457730, 19005218, 8104577300, GN10119-11B1

**JM5443**

 x 1

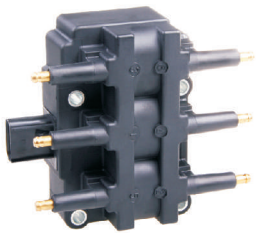

**CHRYSLER, DODGE, JEEP, VOLKSWAGEN**

OEM 56032520AB, 56032520AC, 56032520AE

**JM5444**

 x 1

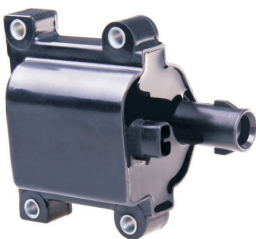

**LEXUS, TOYOTA**

OEM 1908046020, 19080-46020, 9008019016, 90080-19016, 9091902207, 90919-02207

**JM5445**

 x 4

**DACIA, MORGAN, NISSAN, OPEL, RENAULT, VAUXHALL**

OEM 7700107177, 7700113357, 7700875000, 82001541086, 8200154186, 82002008611, 8200208611, 8200380267, 8200405098, 8200568671, 4408389, 91159996, 22448-00QAA, 22448-0QAA, 22448-00QAC, 22448-00QAE, 4413223, 4413233, 215952732, 2526180A, 22448-6N011, 7700113357A

**JM5447**

 x 6

**LEXUS, TOYOTA**

OEM 90919-02251, 90919-A2001, 90919-A2002, 90919-A2002A, 90191-A2003, 909190A2004, 90919-A2004, 90919-A2007

**JM5448**

 x 1



**TOYOTA**

OEM 19017000, 90919-02106, 90919-02015

**JM5449**

 x 1



**TOYOTA**

OEM 19017135, 90919-02154

**JM5450**

 x 3

**INFINITI, NISSAN**

OEM 22448-31U06

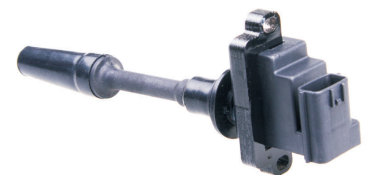
**JM5451**

 x 3

**INFINITI, NISSAN**

OEM 22448-31U01

**JM5453**

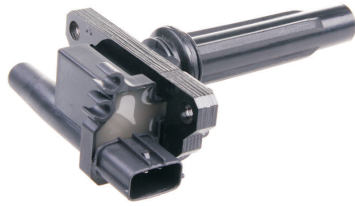

x 2

**MAZDA USA**

OEM 88921413, ZM01-18-100, Zm0118100

**JM5472**

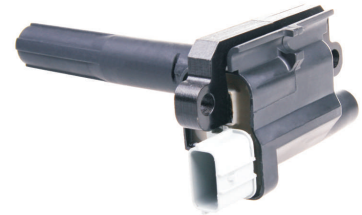

x 2

**CHEVROLET, SUZUKI**

OEM 30020581, 33410-66D10

**JM5455**

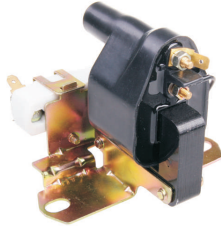

x 1/2

**FIAT, MAZDA, NISSAN, PEUGEOT, RENAULT, TOYOTA ...**

OEM 33410-A60D30, 33410A60D30

**JM5473**

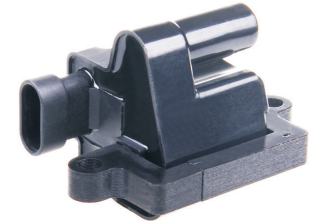

x 8

**CADILLAC, CHEVROLET, GMC, HUMMER, ISUZU**

OEM 12558693, 12570553, 23218007, H6T55171ZC

**JM5458**

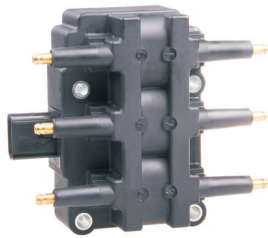

x 1

**DODGE**

OEM 56029098AA, 56032520, 88921268

**JM5474**



x 8

**FORD USA**

OEM 88921347, F6DU12A366AB, F6DZ12029A, F6DZ12029AA, F6DZ12029EA

**JM5459**



x 4

**MAZDA**

OEM N3H1-18-100, N3H1-18-1009U, N3H1-18-100A, N3H1-18-100A9U, N3H1-18-100B, N3H1-18-100B9U

**JM5475**

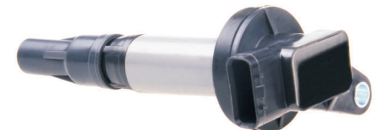

x 8

**JAGUAR, LAND ROVER**

OEM 4526466, 4744015, 6R83-12A366-AA, 6R8312A366AA, AJ810445, AJ83415, AJ87644

**JM5465**

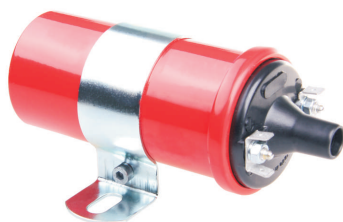

x 1/2

**BMW, DAIHATSU, FIAT, HONDA, RENAULT, SKODA, VOLVO...**

OEM C6R-205

**JM5476**



x 1

**SUBARU**

OEM 22433-44230, 22433-AA230, 22433-AA360

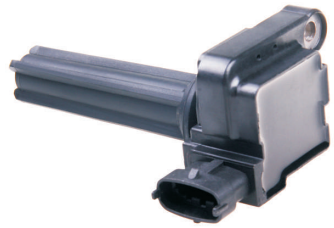
**JM5477**

 x 4

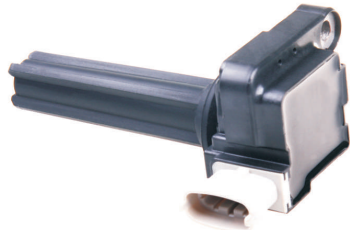
**CADILLAC, OPEL, SAAB, VAUXHALL**
**OEM** H6T60271, 12787707

**JM5478**

 x 4

**CHEVROLET, SATURN**
**OEM** 12584368, 12584369, H6T15171

**JM5482**

 x 3

**MITSUBISHI**
**OEM** MD372035, MD372045

**JM5483**

 x 4

**NISSAN USA, SUZUKI USA**
**OEM** 22448-EA000

**JM5484**

 x 6

**INFINITI, NISSAN**
**OEM** 22448-JA10A, 22448-JA10C

**JM5485**

 x 6/8

**INFINITI, NISSAN**
**OEM** 22448-ZE00A, 22448-ZE00C

**JM5486**

 x 8

**FORD USA, FPV**
**OEM** BR3E-12A375-AA, BR3E12A375AA, BR3Z-12029-A, BR3Z12029A

**JM5487**

 x 1

**MITSUBISHI**
**OEM** Md314582

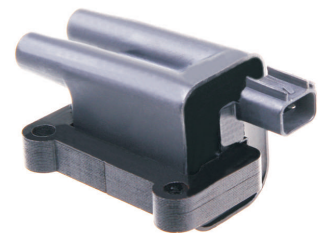
**JM5488**

 x 1

**MITSUBISHI**
**OEM** Md314583

**JM5492**

 x 4

**PONTIAC, SCION, TOYOTA**
**OEM** 90919-02252, 90919-C2003

**JM5494**

 x 1



**AUDI, DACIA, SEAT, SKODA, VOLKSWAGEN**

OEM 032905106, 032905106B

**JM5496**

 x 1



**BUICK, CHEVROLET, GMC, PONTIAC, SATURN**

OEM 12568185, 12579177, 12587153, 12595088, H006T94171ZC, H006T94172ZC, H6T40171ZC, H6T40271ZC, 5114AA145

**JM5497**

 x 8



**INFINITI**

OEM 22433-AR215

**JM5498**

 x 6



**FORD USA, LINCOLN USA, MAZDA USA, MERCURY USA**

OEM 7T4Z-12029-E

**JM5500**

 x 1



**DAEWOO, CHEVROLET**

OEM 1206307, 19005212, 47905104, 96415010, BK4391

**JM5501**

 x 1



**JEEP**

OEM 56041019

**JM5502**

 x 1



**JEEP**

OEM 56041476AA, 56041476AB

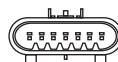
**JM5503**

 x 2



**CADILLAC, PONTIAC USA**

OEM 12567285, 12585765, 89017778

**JM5504**

 x 1



**CADILLAC, OLDSMOBILE USA**

OEM 01104075, 1104075

**JM5505**

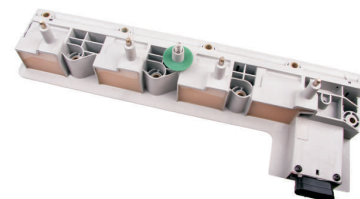

 x 1



**CADILLAC, OLDSMOBILE USA**

OEM 01104076, 1104076

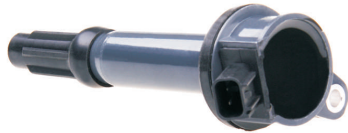

**JM5600**

 x 4/6

**FORD, LINCOLN, MAZDA, MERCURY**

OEM 6E5Z-12029-BA, 6E5E-12A375-BA, 6E5E12A375BB

**JM5606**

 x 6

**MITSUBISHI**

OEM MN187373, MR984160

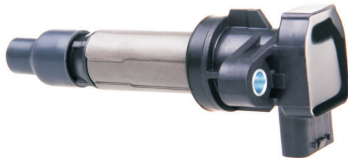
**JM5601**

 x 8

**BUICK, CADILLAC**

OEM 12597745, 42597745

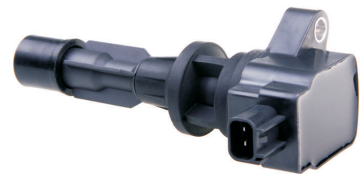
**JM5610**

 x 4

**FORD, MERCURY**

OEM 6E5Z-12029-AA, 6E5Z12029A AFC

**JM5603**

 x 1/2



**NISSAN**

OEM 19017126, 22433-03G01, 22433-03G10, 22433-03G11, 22433-10G10, 22448-03G01, 22448-03G11, 22448-04G01, 22448-04G11, 22448-10G00, 22448-11G00, 22448-11G10, 22448-19B10, 22448-29R10, 22448-32F11, 22448-D4501 ...

**JM5611**

 x 1



**LAND ROVER**

OEM ERR6566

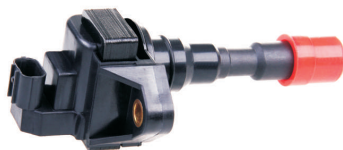
**JM5604**

 x 3

**HONDA**

OEM 30520-PHM-003

**JM5613**

 x 1/2



**FORD, LANCIA, MAZDA, MITSUBISHI, TOYOTA...**

OEM 1473323, 1474549, 1486937, 1591545, 711M-12024-AB, 711M-12024-BA, 71HM-12024-AA, A711M12024AB

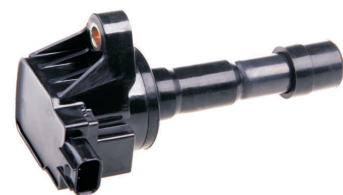
**JM5605**

 x 4

**HONDA**

OEM 30520-RB0-003, 30520RB0003, 30520-RB0-013, 30520RB0013, 30520-RB0-S01, 30520RB0S01

**JM5615**

 x 8

**MERCEDES-BENZ**

OEM 1561500080, 1561500380, 1569060400, 1569060500, 1569060600, A1561500080, A1561500380, A1569060400, A1569060500, A1569060600

### JM5617

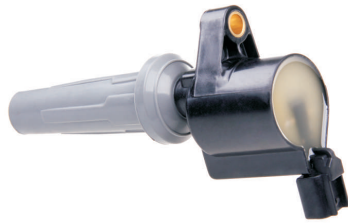

x 4

**FORD, LINCOLN, MAZDA, MERCURY**

OEM 9E5Z-12029-A, 9E5Z12029A, 9E5G12A366AD, 9E5G-12A366-AD, 9E5E12A366AA, 9E5E-12A366-AA

### JM5626



x 3/4

**DAIHATSU, TOYOTA**

OEM 19070B1020

### JM5618



x 1



**CHEVROLET**

OEM 94702536, 2809137

### JM5627



x 8

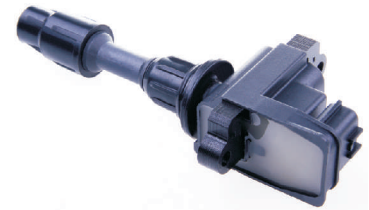

**INFINITI, NISSAN**

OEM 88921362, 22448-3H000, 22448-6P000, 22448-H3000, 22448-3H000, 22448-6P000, 22448-H3000

### JM5622



x 1



**JEEP**

OEM 12336831, 19106487, 1972486, 3230427, 3300427, 8933004522, D5AE12029AB, D5AZ12029A, D5RY12029A, E8AF12029BA, J3230427

### ODM260

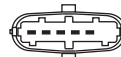

x 1



**CADILLAC, HOLDEN, OPEL, VAUXHALL**

OEM 1208209, 90584336, 9118114

### JM5623



x 1



**SUZUKI**

OEM 33410-80010, 33410-83010, 33410-830V0, 33410-85010

### ODM261

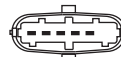

x 1



**CADILLAC, OPEL, VAUXHALL**

OEM 1208210, 90584337, 9118115

### JM5624



x 1



**BUICK, OLDSMOBILE USA, PONTIAC**

OEM 12353801, 24502008, 24502371, 25518356, 25523221, 25526448, 25533542, 914631

### ODM262

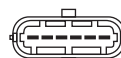

x 1



**ALFA ROMEO, CHEVROLET, HOLDEN, OPEL, VAUXHALL**

OEM 6235124, 9153250, 93172030

## ➤ O FIRMIE

**JANMOR Sp. z o.o.** to czołowy polski dostawca systemów zapłonowych do motoryzacji. Głównymi cechami wyróżniającymi markę JANMOR jest wysoka jakość oraz szeroka gama oferowanych produktów - mamy dostępnych około 1700 referencji przewodów zapłonowych i prawie 600 referencji cewek, które pokrywają bazę 30 tys. modeli pojazdów jeżdżących po drogach Europy.

Celem naszej codziennej pracy jest zaspokajanie potrzeb i oczekiwań Klientów – dlatego chętnie dzielimy się naszą wiedzą i doświadczeniem. Rozwijamy się przy tym na rynkach niszowych, oferując nasze produkty do aut amerykańskich, motocykli, pojazdów zabytkowych, a także wózków widłowych.

JANMOR to marka znana jest nie tylko w Polsce, ale również w ponad kilkudziesięciu krajach świata, do których eksportujemy ponad połowę naszej produkcji. Jesteśmy obecni na wszystkich najważniejszych targach motoryzacyjnych na świecie.

Potwierdzeniem i gwarancją jakości naszych produktów jest certyfikat systemu zarządzania jakością ISO 9001:2008 wydany przez Bureau Veritas Certification Polska oraz wiele innych krajowych i międzynarodowych nagród i wyróżnień, takich choćby jak Przedsiębiorstwo Fair Play czy Gazeta Biznesu.

Jako firma związana bezpośrednio z branżą motoryzacyjną staramy się czynnie angażować w sport motorowy. Wiele załóg startujących w naszych barwach sięgało po tytuły mistrzowskie, co jest dla nas szczególnym powodem do dumy.



no: PL002131/P



The JANMOR logo, consisting of a stylized red and black 'J' symbol followed by the word 'JANMOR' in red capital letters.

